

Our Products Make Your Product Better®

To learn more about EMAC's products and services and how they can help your project

http://ftp.emacinc.com/Tech_Info/About_EMAC_Products_and_Services.pdf



Authorized Distributor, Integrator, and Value-Added Reseller

Manual downloaded from <ftp.emacinc.com>

For purchase information please contact info@emacinc.com

For technical support please submit a ticket at www.emacinc.com/support

User Manual

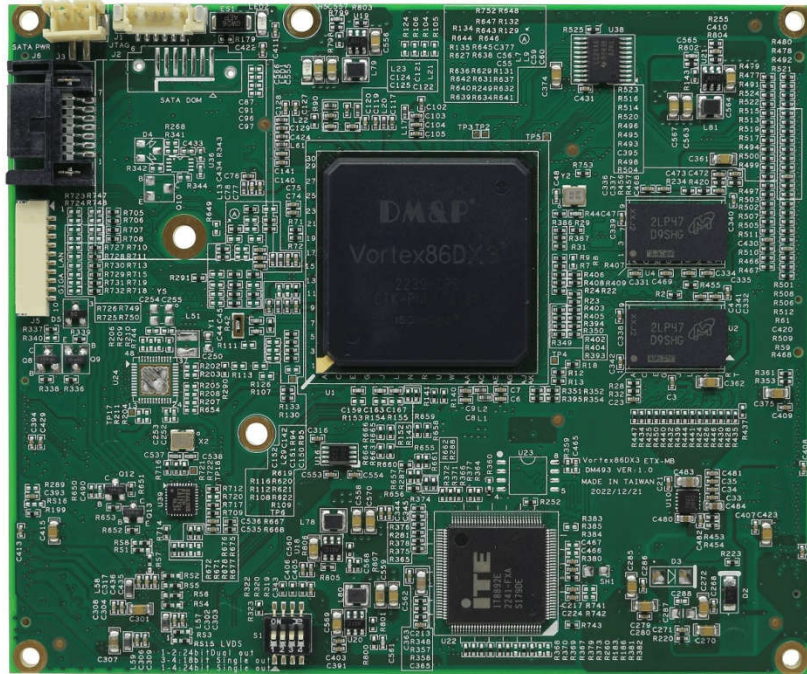

VDX3-ETX-V2

with
DM&P Vortex86DX3
1GHz processor

Version 1.0

Copyright

The information in this manual is subject to change without notice for continues improvement in the product. All rights are reserved. The manufacturer assumers no reasonability for any inaccuracies that may be contained in this document and makes no commitment to update or to keep current the information contained in this manual.

No part of this manual may be reproduced, copied, translated or transmitted, in whole or in part, in any form or by any means without the prior to written permission.

Trademarks Acknowledgement

Vortex86DX3™ is the registered trademark of DM&P Electronics Inc.

Other brand names and product names that appear in this document are the properties and registered trademarks of their respective owners. All names mentioned herewith are served for identification purpose only.

Revision History

Revision	Date	Remark
1.0	SEP 27, 2023	First release

Table of Contents

1	General Information.....	5
1.1	Overview	5
1.2	Block diagram	6
1.3	Specifications	7
1.4	Ordering Information	8
2	Hardware Information	10
2.1	Board Dimension.....	10
2.2	Dimension with heatsink/heatspreader	12
2.3	Connector and Jumper Location	14
2.4	Connector and Jumper Summary	15
2.5	Pin Assignments & Jumper Settings	15
	J1: JTAG.....	15
	J2&J6: SATA DOM.....	15
	J3: SATA DOM Power	16
	J5: Giga Ethernet	16
	S1: LVDS Switch.....	16
	X1: PCI, USB & Audio	17
	X2: ISA	19
	X3: VGA, LVDS, COM x2, PS/2 and Printer(Optional).....	21
	X4: IDE, Ethernet, Power and others	23
2.6	System Mapping.....	25
3	Software Resources.....	28
3.1	Technical Resource Website.....	28
4	Basic BIOS Setting.....	29
4.1	Introduction.....	29
4.2	IDE Configuration.....	29

4.3	Advanced PCI-PnP Setting	30
4.4	ACPI Enable.....	30
5	Basic LCD Panel Setting.....	31
5.1	Introduction.....	31
5.2	Pin Assignment of LVDS.....	31
5.3	Basic BIOS Setting for LCD	32
	Technical Support Directly from	34
	User Manual Feedback	34
	Appendix.....	35
	Warranty.....	36

1 General Information

1.1 Overview

The VDX3-ETX-V2 is a low-power CPU module which compliant with ETX standard. It takes the advantage of Vortex86DX3 1GHz x86 CPU which integrate the PCIe, IDE, I2C, VGA, LVDS, PS/2, USB, HD Audio and even with 16-bit ISA bus support.

The VDX3-ETX-V2 is designed as a plug in replacement, with backward compatibility to support legacy software to help extend existing product life cycle without heavy re-engineering.

1.2 Block diagram

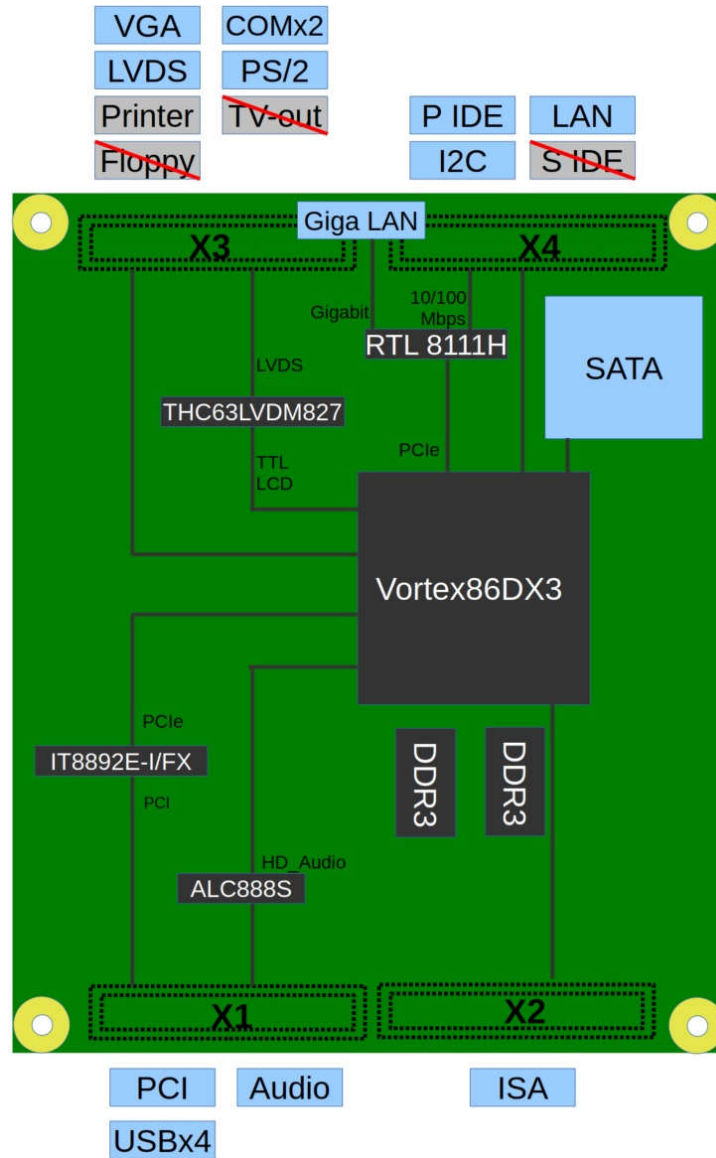

Note:

- ~~Printer~~ :Optional, due to Vortex86DX3 mux pins limitation, either Primary IDE or Printer can used at the same time. Default configuration is IDE, please contact ICOP if you need to use Printer.
- ~~TV-out~~ :TV-out is not available on this board.
- ~~Floppy~~ :Floppy is not available on this board.
- ~~S IDE~~ :Secondary IDE pins on X4 connector is not available. The Secondary IDE is for SATA on this board.

1.3 Specifications

Processor	DM&P SoC CPU Vortex86DX3 - 1GHz Real Time Clock with Lithium Battery Backup
Cache	L1:32KB I-Cache, 32KB D-Cache, L2:512KB Cache
Display	Integrated 2D VGA chipset with Dual Display Support (VGA+LVDS) Share 16MB to 256MB system memory 18/24-bit single channel LVDS (default 24-bit) 24-bit Dual channel LVDS (Optional) VGA: Maximum resolution up to 1920x1080 LVDS(Single): Maximum resolution up to 1024x768 LVDS(Dual): Maximum resolution up to 1920x1080
System Memory	512MB/1GB/2GB DDR3 Onboard
BIOS	AMI BIOS
Expansion Bus	PCI, ISA, and I ² C.
Watchdog Timer	Software programmable from 30.5u sec. to 512 sec. x2 sets (Watchdog 1 fully compatible with M6117D)
LAN	Realtek 8111H, 10/100/1000Mbps Ethernet (Default 10/100 mode)
Audio	HD Audio
Connector	SATA, 7P Connector x1, 2P connector for SATA power x1. 1000Mbps Ethernet, 10P Connector x1 X1: PCI, USB, Audio, USBx4 X2: ISA X3: VGA, LVDS, COM x2 ,PS/2 and Printer X4: IDE, Ethernet, Power and others (Optional: Printer on X3)
Power Requirement	Single Voltage +5V@1300mA. (Typical)
Weight	110g
Dimensions	95mm x 114mm (3.7 x 4.5 inches)
Operating Temp.	-20°C ~ +70°C -40°C ~ +85°C (Optional)
Operating System Support	Free DOS, DOS6.22, PCDOS 7.1, DR-DOS, X-DOS, OS/2, Windows CE7.0, Windows Professional, Windows Embedded Standard (XPE), POS Ready (WePOS), Windows 7/7Embedded, Embedded Linux, QNX, Vxworks and FreeBSD

1.4 Ordering Information

Module:

Item number	Product Description
VDX3-ETX-53IS-V2	Vortex86DX3 ETX Module (800MHz) with 512MB DDR3 /2S/4USB/LAN/VGA/LCD(18/24-bit) /AUDIO/PCI/SATA/ IDE, -10 to +60°C
VDX3-ETX-74IE-V2	Vortex86DX3 ETX Module with 1GB DDR3/2S/4USB/LAN/VGA/LCD(18/24-bit) /AUDIO/PCI/SATA(Vertical Connector)/ IDE, -20 to +70°C
VDX3-ETX-74IE-H-V2	Vortex86DX3 ETX Module with 1GB DDR3/2S/4USB/LAN/VGA/LCD(18/24-bit) /AUDIO/PCI/SATA(Horizontal Connector)/ IDE, -20 to +70°C
VDX3-ETX-75IE-V2	Vortex86DX3 ETX Module with 2GB DDR3/2S/4USB/LAN/VGA/LCD(18/24-bit) /AUDIO/PCI/SATA(Vertical Connector)/ IDE, -20 to +70°C
VDX3-ETX-75IE-H-V2	Vortex86DX3 ETX Module with 2GB DDR3/2S/4USB/LAN/VGA/LCD(18/24-bit) /AUDIO/PCI/SATA(Horizontal Connector)/ IDE, -20 to +70°C

*Default setting for processor on VDX3-ETX-V2 module is Single-core. If Dual-core processor is required, please contact your distributor

**24-bit Signal channel LVDS running with VDX3-ETX-V2 module as default. If 24-bit Dual channel LVDS is required, please contact your distributor

Heatsink (For detail, please see Chapter 2.3):

Item Number	Product Description
Heatspreader-ETX-D3T	2mm height heatspreader.
Heatsink-ETX-D3T	15mm height heatsink

Accessories:

Item Number	Product Description
VDX3-ETX-I-DEV	Carrier Board for Evaluation

For detail, please refer to Appendix

Storages:

Product Name	MLC	SLC	0°C ~ +70°C	-40°C ~ +85°C
ISATA-8G-H-M	V		V	
ISATA-16G-H-M	V		V	
ISATA-32G-H-M	V		V	
ISATA-4G-H-M-X	V			V
ISATA-8G-H-M-X	V			V
ISATA-16G-H-M-X	V			V
ISATA-32G-H-M-X	V			V
ISATA-1G-H-S		V	V	
ISATA-2G-H-S		V	V	
ISATA-4G-H-S		V	V	
ISATA-8G-H-S		V	V	
ISATA-16G-H-S		V	V	
ISATA-16G-H-S-X		V		V

2 Hardware Information

2.1 Board Dimension

Top View

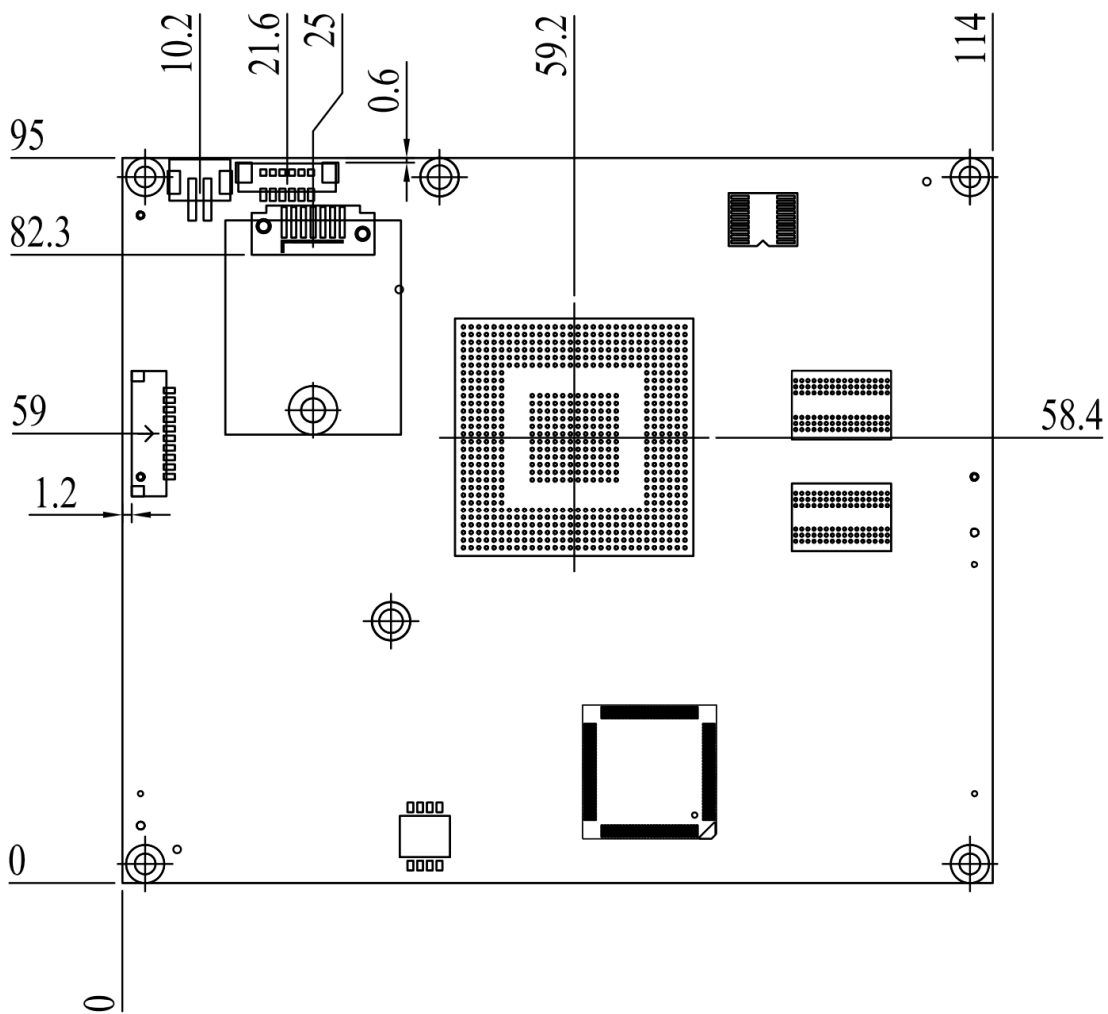

Bottom View

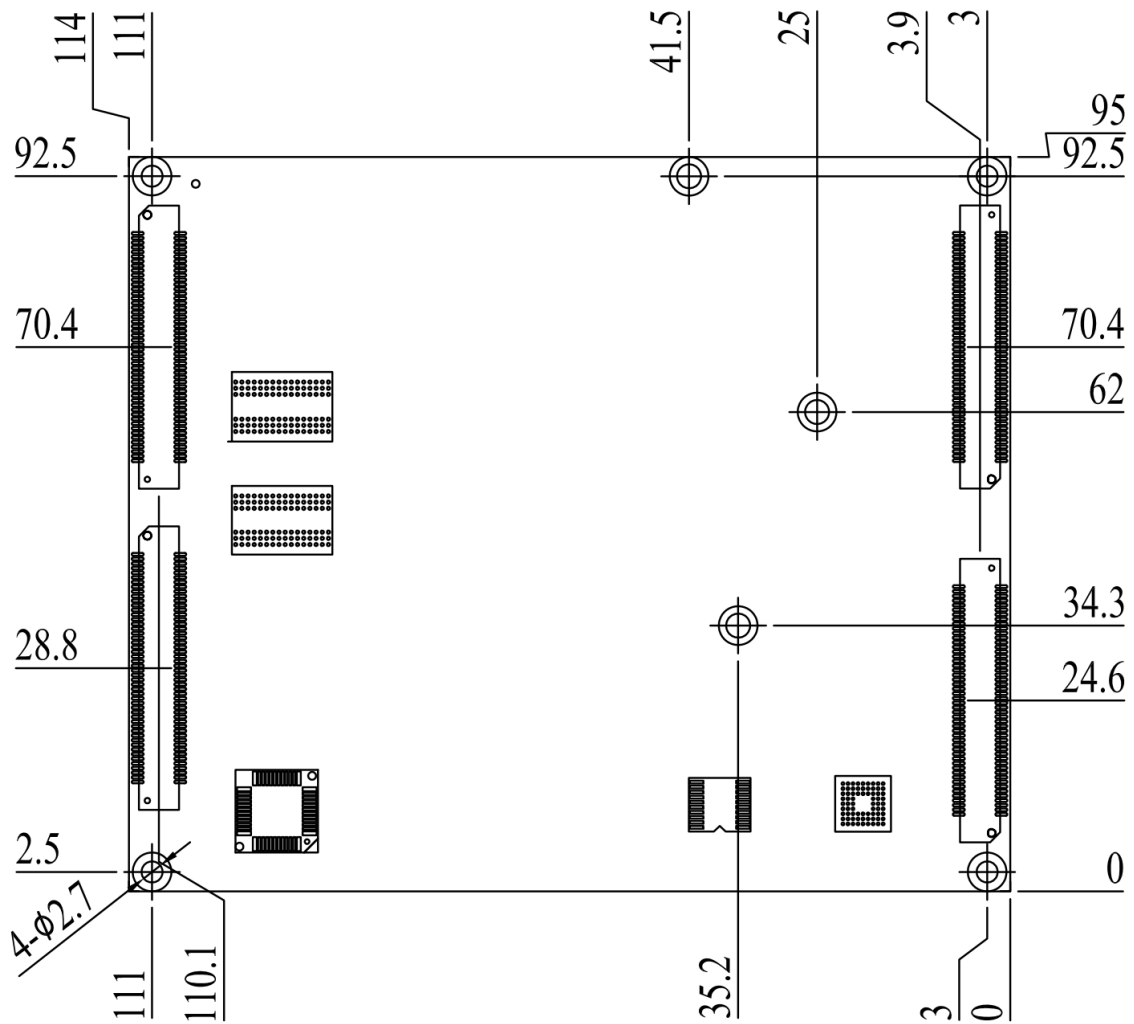

2.2 Dimension with heatsink/heatspreader

With heatsink (item number: Heatsink-ETX-D3T)

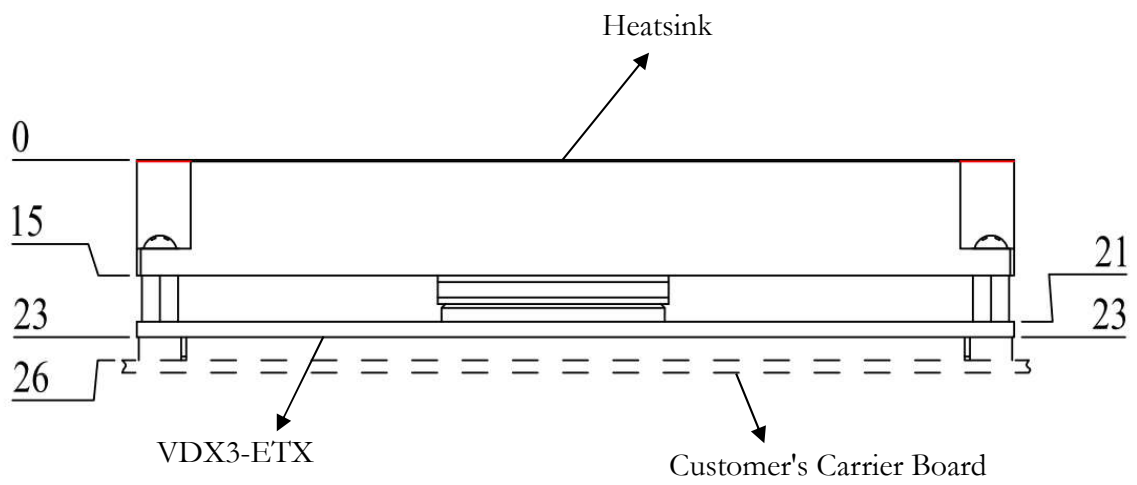
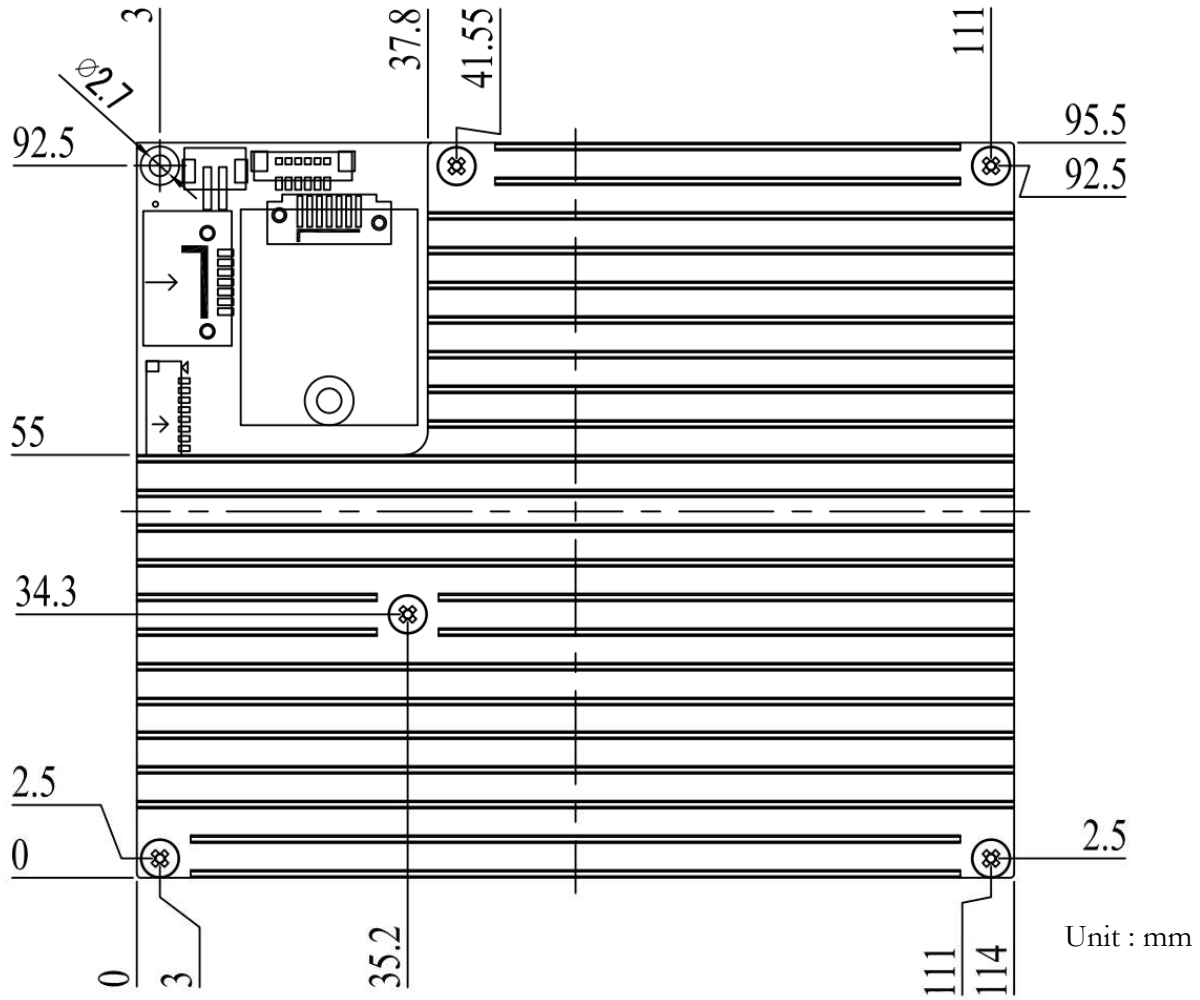

With heatspreader (item number: Heatspreader-ETX-D3T)

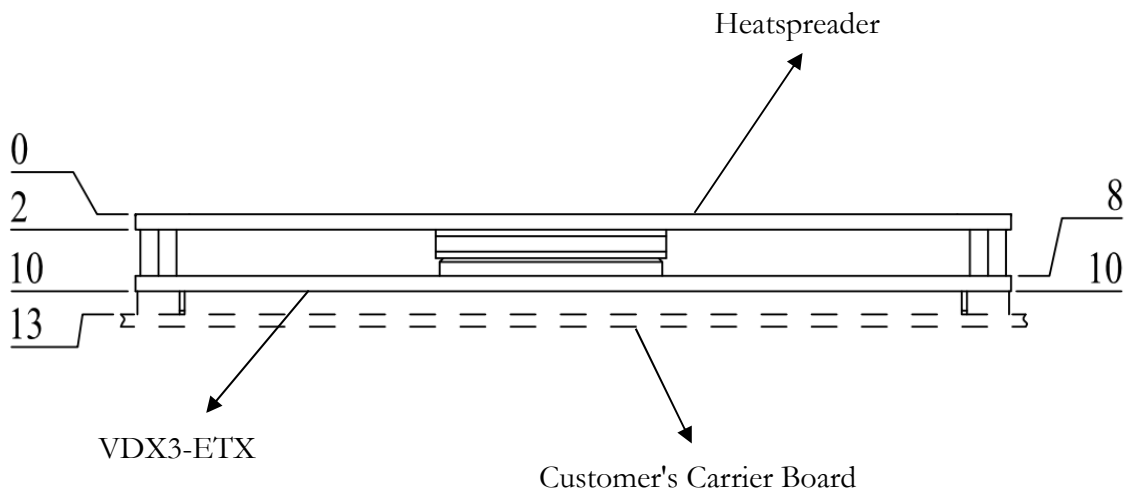
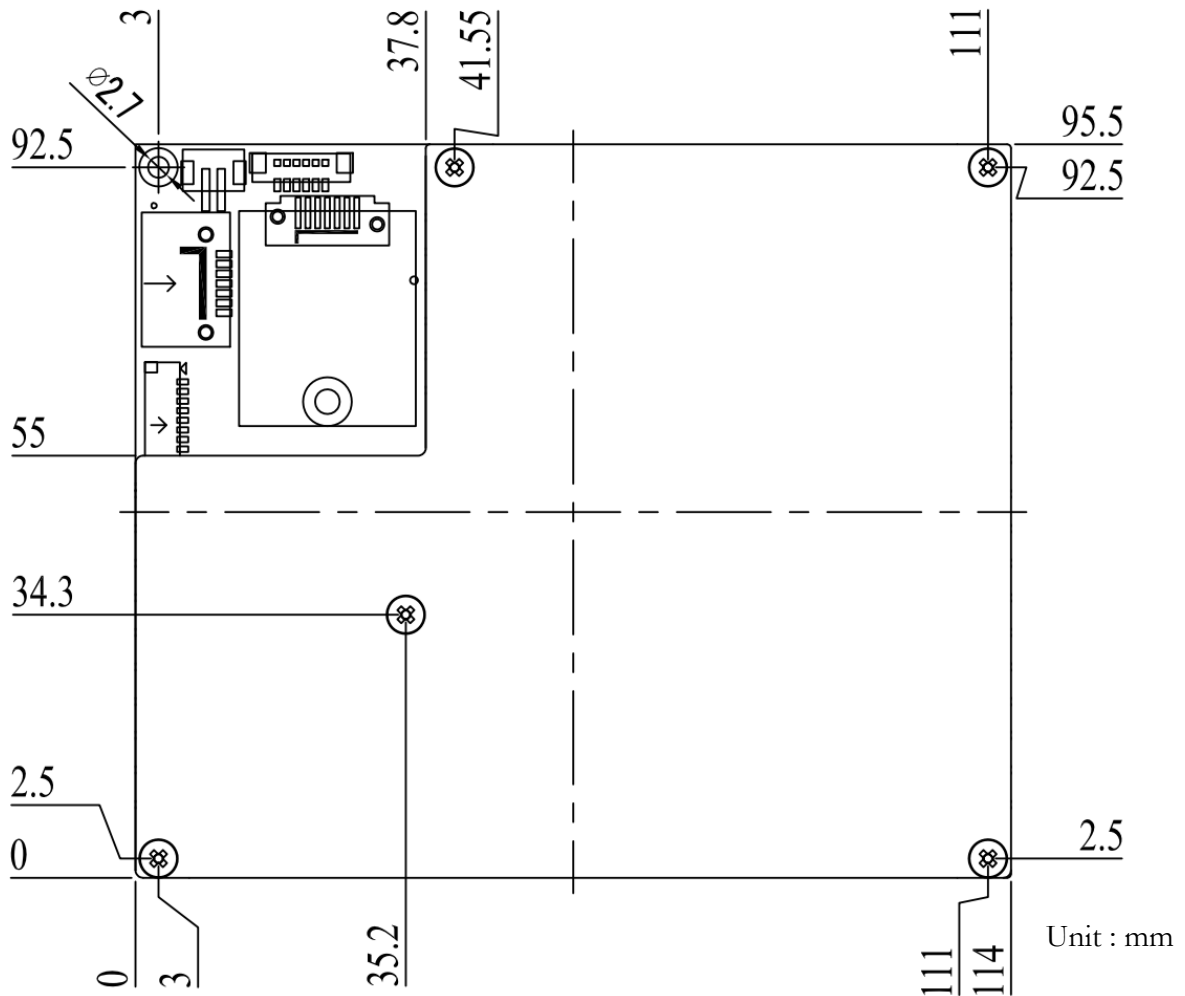

2.3 Connector and Jumper Location

Top View

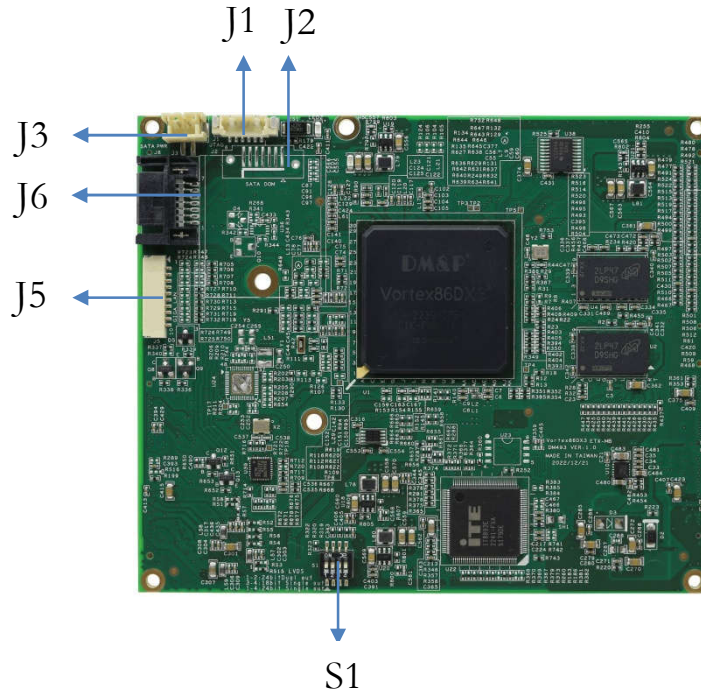

Bottom View

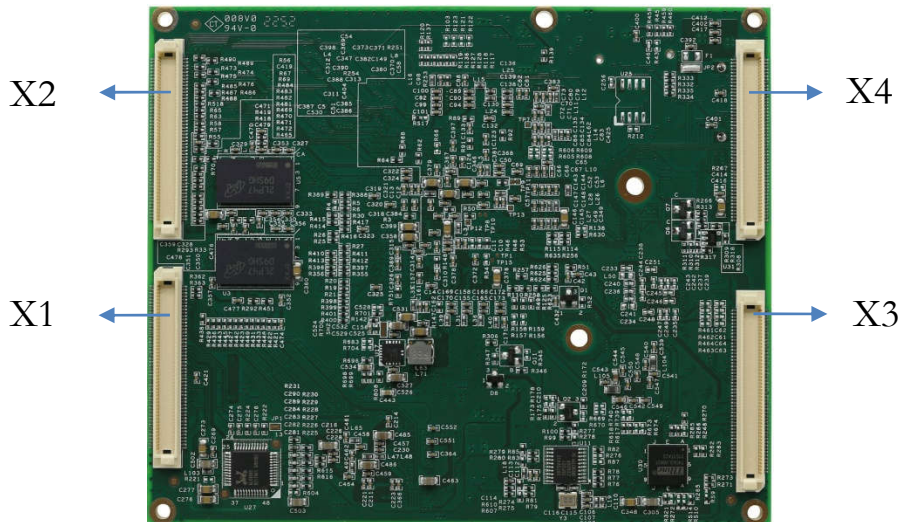

2.4 Connector and Jumper Summary

Nbr.	Name	Type of Connections	Pin Nbr
J1	JTAG	Wafer, 1.25mm, 1x6	6
J2	SATA DOM	SATA 7P Connector, 7x1	7
J3	SATA DOM Power	Box Header, 2.0mm, 1x2	2
J5	Giga Ethernet	Wafer. 1.25mm 10x1	10
J6	SATA DOM (Horizontal Type)	SATA 7P Connector, 7x1 (Optional)	7
S1	LVDS Switch	Dip Switch	4
LED1	MTBF LED	SMD LED, Orange	/
LED2	Power LED	SMD LED, Red	/
X1	X1 connector	ETX 100 pins connector	100
X2	X2 connector	ETX 100 pins connector	100
X3	X3 connector	ETX 100 pins connector	100
X4	X4 connector	ETX 100 pins connector	100

2.5 Pin Assignments & Jumper Settings

J1: JTAG

For internal use only.

J2&J6: SATA DOM

Pin#	Single Name	Pin #	Single Name
1.	GND	2	TX+
3	TX-	4	GND
5	RX-	6	RX+
7	GND	/	/

J6 is an optional SATA DOM horizontal connector.

J3: SATA DOM Power

Pin#	Single Name	Pin #	Single Name
1.	VCC	2	GND

J5: Giga Ethernet

Pin#	Single Name	Pin #	Single Name
1.	MDI 0+	2	MDI 0-
3	MDI 1+	4	MDI 1-
5	MDI 2+	6	MDI 2-
7	MDI 3+	8	MDI 3-
9	LED1/Link_Active	10	LED/Duplex

(Giga Ethernet cable is required for testing Giga Ethernet function. The cable is not in standard package.)

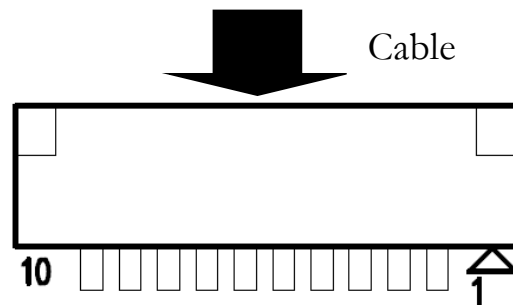

S1: LVDS Switch

18-Bit LVDS Support

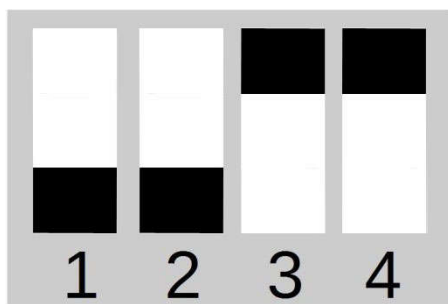

24-Bit LVDS Support

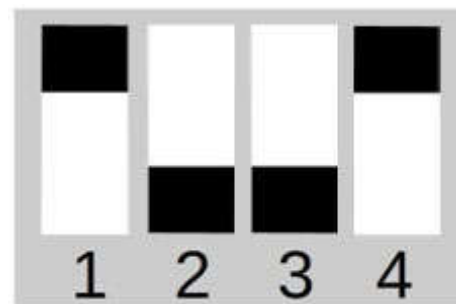

X1: PCI, USB & Audio

Pin	Signal	Voltage	5V I/O tolerant	Pin	Signal	Voltage	5V I/O Tolerant
A1	GND	-	-	A2	GND	-	-
A3	PCICLK2	VCC3	-	A4	PCICLK3	VCC3	-
A5	GND	-	-	A6	GND	-	-
A7	PCICLK0	VCC3	-	A8	PCICLK1	VCC3	-
A9	REQ3#	VCC3	-	A10	GNT3#	VCC3	-
A11	GNT2#	VCC3	-	A12	3V	-	-
A13	REQ2#	VCC3	-	A14	GNT1#	VCC3	-
A15	REQ1#	VCC3	-	A16	3V	-	-
A17	GNT0#	VCC3	-	A18	RESERVED	-	-
A19	VCC	-	-	A20	VCC	-	-
A21	Not supported	-	-	A22	REQ0#	VCC3	-
A23	AD0	VCC3	-	A24	3V	-	-
A25	AD1	VCC3	-	A26	AD2	VCC3	-
A27	AD4	VCC3	-	A28	AD3	VCC3	-
A29	AD6	VCC3	-	A30	AD5	VCC3	-
A31	CBE0#	VCC3	-	A32	AD7	VCC3	-
A33	AD8	VCC3	-	A34	AD9	VCC3	-
A35	GND	-	-	A36	GND	-	-
A37	AD10	VCC3	-	A38	AUXAL	VCC	-
A39	AD11	VCC3	-	A40	MIC	VCC	-
A41	AD12	VCC3	-	A42	AUXAR	VCC	-
A43	AD13	VCC3	-	A44	ASVCC	VCC	-
A45	AD14	VCC3	-	A46	SNDL	VCC	-
A47	AD15	VCC3	-	A48	ASGND	.-	-
A49	CBE1#	VCC3	-	A50	SNDR	VCC	-

Pin	Signal	Voltage	5V I/O tolerant	Pin	Signal	Voltage	5V I/O Tolerant
A51	VCC	-	-	A52	VCC	-	-
A53	PAR	VCC3	-	A54	SERR#	VCC3	-
A55	GPERR#	VCC3	-	A56	RESERVED	-	-
A57	PME#	VCC3	-	A58	USB2-	VCC3	-
A59	LOCK#	VCC3	-	A60	DEVSEL#	VCC3	-
A61	TRDY#	VCC3	-	A62	USB3-	VCC3	-
A63	IRDY#	VCC3	-	A64	STOP#	VCC3	-
A65	FRAME#	VCC3	-	A66	USB2+	VCC3	-
A67	GND	-	-	A68	GND	-	-
A69	AD16	VCC3	-	A70	CBE2#	VCC3	-
A71	AD17	VCC3	-	A72	USB3+	VCC3	-
A73	AD19	VCC3	-	A74	AD18	VCC3	-
A75	AD20	VCC3	-	A76	USB0-	VCC3	-
A77	AD22	VCC3	-	A78	AD21	VCC3	-
A79	AD23	VCC3	-	A80	USB1-	VCC3	-
A81	AD24	VCC3	-	A82	CBE3#	VCC3	-
A83	VCC	-	-	A84	VCC	-	-
A85	AD25	VCC3	-	A86	AD26	VCC3	-
A87	AD28	VCC3	-	A88	USB0+	VCC3	-
A89	AD27	VCC3	-	A90	AD29	VCC3	-
A91	AD30	VCC3	-	A92	USB1+	VCC3	-
A93	PCIRST#	VCC3	-	A94	AD31	VCC3	-
A95	INTC#	VCC3	-	A96	INTD#	VCC3	-
A97	INTA#	VCC3	-	A98	INTB#	VCC3	-
A99	GND	-	-	A100	GND	-	-

X2: ISA

Pin	Signal	Voltage	5V I/O tolerant	Pin	Signal	Voltage	5V I/O Tolerant
B1	GND	-	-	B2	GND	-	-
B3	SD14	VCC		B4	SD15	VCC	
B5	SD13	VCC		B6	MASTER#	-	-
B7	SD12	VCC		B8	DREQ7	VCC	
B9	SD11	VCC		B10	DACK7#	VCC3	Y
B11	SD10	VCC		B12	DREQ6	VCC	
B13	SD9	VCC		B14	DACK6#	VCC3	Y
B15	SD8	VCC		B16	DREQ5	VCC	
B17	MEMW#	VCC		B18	DACK5#	VCC3	Y
B19	MEMR#	VCC		B20	DREQ0	VCC	
B21	LA17	VCC		B22	DACK0#	VCC3	Y
B23	LA18	VCC		B24	IRQ14	VCC	
B25	LA19	VCC		B26	IRQ15	VCC	
B27	LA20	VCC		B28	IRQ12	VCC	
B29	LA21	VCC		B30	IRQ11	VCC	
B31	LA22	VCC		B32	IRQ10	VCC	
B33	LA23	VCC		B34	IOCS16#	VCC	
B35	GND	-		B36	GND	-	-
B37	SBHE#	VCC3	Y	B38	MEMCS16#	VCC	
B39	SA0	VCC		B40	OSC	VCC	
B41	SA1	VCC		B42	BALE	VCC3	Y
B43	SA2	VCC		B44	TC	VCC3	Y
B45	SA3	VCC		B46	DACK2 #	VCC3	Y
B47	SA4	VCC		B48	IRQ3	VCC	
B49	SA5	VCC		B50	IRQ4	VCC	

Pin	Signal	Voltage	5V I/O tolerant	Pin	Signal	Voltage	5V I/O Tolerant
B51	VCC	-	-	B52	VCC	-	-
B53	SA6	VCC		B54	IRQ5	VCC	
B55	SA7	VCC		B56	IRQ6	VCC	
B57	SA8	VCC		B58	IRQ7	VCC	
B59	SA9	VCC		B60	SYSCLK	VCC	
B61	SA10	VCC		B62	REFSH#	VCC3	Y
B63	SA11	VCC		B64	DREQ1	VCC	
B65	SA12	VCC		B66	DACK1#	VCC3	Y
B67	GND	-	-	B68	GND	-	-
B69	SA13	VCC		B70	DREQ3	VCC	
B71	SA14	VCC		B72	DACK3#	VCC3	Y
B73	SA15	VCC		B74	IOR#	VCC	
B75	SA16	VCC		B76	IOW#	VCC	
B77	SA18	VCC		B78	SA17	VCC	
B79	SA19	VCC		B80	SMEMR#	VCC	
B81	IOCHRDY	VCC		B82	AEN	VCC3	Y
B83	VCC	-	-	B84	VCC	-	-
B85	SD0	VCC		B86	SMEMW#	VCC	
B87	SD2	VCC		B88	SD1	VCC	
B89	SD3	VCC		B90	OWS#	VCC3	Y
B91	DREQ2	VCC		B92	SD4	VCC	
B93	SD5	VCC		B94	IRQ9	VCC	
B95	SD6	VCC		B96	SD7	VCC	
B97	IOCHK#	VCC		B98	RSTDRV	VCC3	Y
B99	GND	-	-	B100	GND	-	-

X3: VGA, LVDS, COM x2, PS/2 and Printer(Optional)

Pin	Signal	Voltage	5V I/O tolerant	Pin	Signal	Voltage	5V I/O Tolerant
C1	GND	-	-	C2	GND	-	-
C3	R	-	-	C4	B	-	-
C5	HSY	VCC	-	C6	G	-	-
C7	VSX	VCC	-	C8	DDCK	VCC3	-
C9	DETECT#	VCC3	-	C10	DDDA	VCC3	-
C11	TXLCK1-	VCC1.8	-	C12	TXOUT13-	VCC1.8	-
C13	TXLCK1+	VCC1.8	-	C14	TXOUT13+	VCC1.8	-
C15	GND	-	-	C16	GND	-	-
C17	TXOUT11+	VCC1.8	-	C18	TXOUT12+	VCC1.8	-
C19	TXOUT11-	VCC1.8	-	C20	TXOUT12-	VCC1.8	-
C21	GND	-	-	C22	GND	-	-
C23	TXOUT3-	VCC1.8	-	C24	TXOUT10+	VCC1.8	-
C25	TXOUT3+	VCC1.8	-	C26	TXOUT10-	VCC1.8	-
C27	GND	-	-	C28	GND	-	-
C29	TXOUT2-	VCC1.8	-	C30	TXLCK+	VCC1.8	-
C31	TXOUT2+	VCC1.8	-	C32	TXLCK-	VCC1.8	-
C33	GND	-	-	C34	GND	-	-
C35	TXOUT0+	VCC1.8	-	C36	TXOUT1+	VCC1.8	-
C37	TXOUT0-	VCC1.8	-	C38	TXOUT-	VCC1.8	-
C39	VCC	-	-	C40	VCC	-	-
C41	Not supported	-	-	C42	Not supported	-	-
C43	Not supported	-	-	C44	BLON#	-	-
C45	BIASON	-	-	C46	DIGON#	-	-
C47	COMP	VCC3	-	C48	Y	VCC3	-
C49	Not supported	-	-	C50	C	VCC3	-

 :First Channel LVDS

 :Second Channel LVDS

Pin	Signal	Voltage	5V I/O tolerant	Pin	Signal	Voltage	5V I/O Tolerant
C51	LPT	VCC3	Y	C52	Not supported	-	-
C53	VCC	-	-	C54	GND	-	-
C55	STB#	VCC3	-	C56	AFD#	VCC3	-
C57	Not supported	-	-	C58	PD7	VCC3	Y
C59	Not supported			C60	ERR#	VCC3	Y
C61	Not supported			C62	PD6	VCC3	Y
C63	RXD2	VCC3	Y	C64	INT#	VCC3	-
C65	GND	-	-	C66	GND	-	-
C67	RTS2#	VCC3	-	C68	PD5	VCC3	Y
C69	DTR2#	VCC3	-	C70	SLIN#	VCC3	-
C71	DCD2#	VCC3	Y	C72	PD4	VCC3	Y
C73	DSR2#	VCC3	Y	C74	PD3	VCC3	Y
C75	CTS2#	VCC3	Y	C76	PD2	VCC3	Y
C77	TXD2	VCC3	-	C78	PD1	VCC3	Y
C79	RI2#	VCC3	Y	C80	PD0	VCC3	Y
C81	VCC	-	-	C82	VCC	-	-
C83	RXD1	VCC3	Y	C84	ACK#	VCC3	Y
C85	RTS1#	VCC3	-	C86	BUSY#	VCC3	Y
C87	DTR1#	VCC3	-	C88	PE	VCC3	Y
C89	DCD1#	VCC3	Y	C90	SLCT#	VCC3	-
C91	DSR1#	VCC3	Y	C92	MSCLK	VCC3	Y
C93	CTS1#	VCC3	Y	C94	MSDAT	VCC3	Y
C95	TXD1#	VCC3	-	C96	KBCLK	VCC3	Y
C97	RI1#	VCC3	Y	C98	KBDAT	VCC3	Y
C99	GND	-	-	C100	GND	-	-

X4: IDE, Ethernet, Power and others

Pin	Signal	Voltage	5V I/O tolerant	Pin	Signal	Voltage	5V I/O Tolerant
D1	GND	-	-	D2	GND	-	-
D3	5V_SB	-	-	D4	PWGIN	VCC	-
D5	PS_ON#	VSB5	-	D6	SPEAKER	VCC3	-
D7	PWRBTN#	VSB5	-	D8	BATT	VCC3	-
D9	Not supported	-	-	D10	LILED	VCC3	-
D11	Not supported	-	-	D12	ACTLED	VCC3	-
D13	Not supported	-	-	D14	Not supported	-	-
D15	Not supported	-	-	D16	I2CLK	VCC3	Y
D17	VCC	-	-	D18	VCC	-	-
D19	Not supported	-	-	D20	GPCS#	VCC3	Y
D21	Not supported	-	-	D22	I2DAT	VCC3	Y
D23	Not supported	-	-	D24	Not supported	-	-
D25	Not supported	-	-	D26	Not supported	-	-
D27	Not supported	-	-	D28	Not supported	-	-
D29	Not supported	-	-	D30	PIDE_CS3#	VCC3	Y
D31	Not supported	-	-	D32	PIDE_CS1#	VCC3	Y
D33	GND	-	-	D34	GND	-	-
D35	Not supported	-	-	D36	PIDE_A2	VCC3	Y
D37	Not supported	-	-	D38	PIDE_A0	VCC3	Y
D39	Not supported	-	-	D40	PIDE_A1	VCC3	Y
D41	Not supported	-	-	D42	Not supported		
D43	Not supported	-	-	D44	PIDE_INTRQ	VCC3	Y
D45	Not supported	-	-	D46	PIDE_AK#	VCC3	Y
D47	Not supported	-	-	D48	PIDE_RDY	VCC3	Y
D49	VCC	-	-	D50	VCC	-	-

Pin	Signal	Voltage	5V I/O tolerant	Pin	Signal	Voltage	5V I/O Tolerant
D51	Not supported	-	-	D52	PIDE_IOR#	VCC3	Y
D53	Not supported	-	-	D54	PIDE_IOW#	VCC3	Y
D55	Not supported	-	-	D56	PIDE_DRQ	VCC3	Y
D57	Not supported	-	-	D58	PIDE_D15	VCC3	Y
D59	Not supported	-	-	D60	PIDE_D0	VCC3	Y
D61	Not supported	-	-	D62	PIDE_D14	VCC3	Y
D63	Not supported	-	-	D64	PIDE_D1	VCC3	Y
D65	GND	-	-	D66	GND	-	-
D67	Not supported	-	-	D68	PIDE_D13	VCC3	Y
D69	Not supported	-	-	D70	PIDE_D2	VCC3	Y
D71	Not supported	-	-	D72	PIDE_D12	VCC3	Y
D73	Not supported	-	-	D74	PIDE_D3	VCC3	Y
D75	Not supported	-	-	D76	PIDE_D11	VCC3	Y
D77	Not supported	-	-	D78	PIDE_D4	VCC3	Y
D79	Not supported	-	-	D80	PIDE_D10	VCC3	Y
D81	VCC	-	-	D82	VCC	-	-
D83	Not supported	-	-	D84	PIDE_D5	VCC3	Y
D85	Not supported	-	-	D86	PIDE_D9	VCC3	Y
D87	Not supported	-	-	D88	PIDE_D6	VCC3	Y
D89	Not supported	-	-	D90	CBLID_P	VCC3	Y
D91	RXD-	VCC3	-	D92	PIDE_D8	VCC3	Y
D93	RXD+	VCC3	-	D94	SIDE_D7	VCC3	Y
D95	TXD-	VCC3	-	D96	PIDE_D7	VCC3	Y
D97	TXD+	VCC3	-	D98	HDRST#	VCC3	Y
D99	GND	-	-	D100	GND	-	-

2.6 System Mapping

Memory Mapping		
Address	Description	Usage
00000000 – 0009FFFF	System RAM	*
000A0000 – 000AFFFF	EGA/VGA Video Memory	*
000B0000 – 000B7FFF	MDA RAM, Hercules graphics display RAM	*
000B8000 – 000BFFFF	CGA display RAM	*
000C0000 – 000C7FFF	EGA/VGA BIOS ROM	*
000C8000 – 000CFFFF	Boot ROM enable	
000CC000 – 000CFFFF	Console Redirection enable	
000D0000 – 000D7FFF	Expansion ROM space	
000D8000 – 000D8FFF	SPI Flash Emulation Floppy A Enable	
000DC000 – 000DFFFF	Expansion ROM Space	
000E0000 – 000EFFFF	USB Legacy SCSI ROM space	
000F0000 – 000FFFFFFF	Motherboard BIOS	*
FEFDBC00 – FEFDBCFF	Standard OpenHCD USB Host Controller	*
FEFBB400 – FEFBB4FF	Onboard Ethernet Adapter	*
FEFDB800 – FEFDBFFF	Standard Enhanced PCI to USB Host Controller	*

I/O Mapping		
Address	Description	Usage
0000h – 000Fh	DMA 8237-1	*
0020h – 0021h	PIC 8259-1	*
0022h – 0023h	Indirect Access Registers (6117D configuration port)	*
0040h – 0043h	Timer Counter 8254	*
0060h	Keyboard / Mouse data port	
0061h	Port B + NMI control port	*
0062h – 0063h	8051 download 4k address counter	
0064h	Keyboard/ Mouse status/ command port	
0065h	WatchDog0 reload counter	
0070h – 0071h	CMOS RAM port	*
0072h – 0075h	MTBF control register	*
0078h – 007Ch	GPIO port 0,1,2,3,4 default setup	*
0080h – 008Fh	DMA page register	
0092h	System control register	*

0093h – 0097h	GPIO port 6,7,8,9,A direction control	*
0098h – 009Dh	GPIO port 0,1,2,3,4,5 direction control	*
00A0h – 00A1h	PIC 8259-2	*
00A8h – 00ADh	WatchDog1 control counter	*
00AEh	WatchDog1 reload counter	*
00C0h – 00DFh	DMA 8237-2	*
00E0h – 00EFh	DOS 4G Page access	*
0100h – 0105h	GPIO port 5,6,7,8,9,A default setup	*
0170h – 0177h	IDE 1(IRQ 15)	*
0278h – 027Fh	Printer port (IRQ7, DMA 0)	*
02E8h – 02EFh	COM4 (IRQ 11)	*
02F8h – 02FFh	COM2 (IRQ 3)	*
03E8h – 03EFh	COM3 (IRQ 10)	*
03F6h	IDE1 ATAPI device control write only register	*
03F8h – 03FFh	COM1 (IRQ 4)	*
0480h – 048Fh	DMA High page register	*
0490h – 0499h	Instruction counter register	*
04D0h – 04D1h	8259 Edge / level control register	*
0CF8h – 0CFh	PCI configuration port	*
DE00h – DEFFh	On board LAN	*
FC00h – FC05h	SPI Flash BIOS control register	*
FC08h – FC0Dh	External SPI BUS control register	*

IRQ Mapping		
Address	Description	Usage
IRQ0	System Timer	*
IRQ1	Keyboard Controller	*
IRQ2	Cascade for IRQ8~15	
IRQ3	Serial port 2	*
IRQ4	Serial port 1	*
IRQ5	USB	*
IRQ6	USB	
IRQ7	USB/Ethernet 10/100M LAN	*
IRQ8	Real Timer Clock	*
IRQ9	Multimedia Device	*
IRQ10	Serial Port 3	*
IRQ11	Serial Port 4	*

IRQ12	Mouse	*
IRQ13	Math Coprocessor	*
IRQ14	Hard Disk Controller #1	*
IRQ15	Hard Disk Controller #2	*

4 Basic BIOS Setting

4.1 Introduction

Featuring AMI BIOS, the VDX3-ETX-V2 module is a one stable module board for your applications. In this section, we will introduce you some basic AMI BIOS setting such as CPU speed adjusting, console redirection, and IDE configuration, etc.

4.2 IDE Configuration

The default IDE configuration is for Windows Operating System, and the setting as below:

Onboard IDE Operate Mode: [Legacy Mode]

IDE Compatibility: [Disabled]

If you would like to use Linux on VDX3-ETX-V2, please follow below instructions:

Onboard IDE Operate Mode: [Native Mode]

IDE Compatibility: [Enabled]

Path of Onboard IDE Operate Mode:

Advanced > IDE Configuration > IDE Operate Mode [Native Mode]

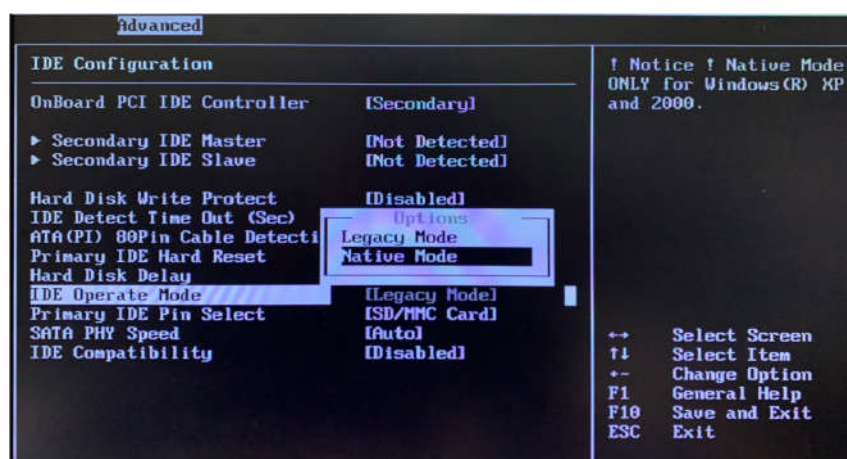

4.3 Advanced PCI-PnP Setting

Two statuses for IRQ setting:

[Reserved]: IRQ will be free to be allocated by ISA device, not PCI device.

[Available]: IRQ will be allocated by both ISA device and PCI device.

Path: PCIPnP >IRQ

4.4 ACPI Enable

To install Windows 7 on computer boards, please enable ACPI as the following instruction.

Path: Advanced > ACPI Configuration >ACPI Aware O/S

5 Basic LCD Panel Setting

5.1 Introduction

The VDX3-ETX-V2 offers two different interfaces which support maximum resolution up to 1920 x 1080 (at 60 MHz) connecting to VGA and LCD Flat Panel with 18-bit/24bit LVDS.

The default setting of **Boot Display Device [VBIOS]** and **LCD Panel Index [VBIOS]** with **Clone Display [ENBALED]** support dual display (LCD and VGA) on VDX3-ETX-V2.

If your VGA display shifts because of the above setting, please switch **Boot Display Device [VBIOS]** to **[CRT]** as the following image:

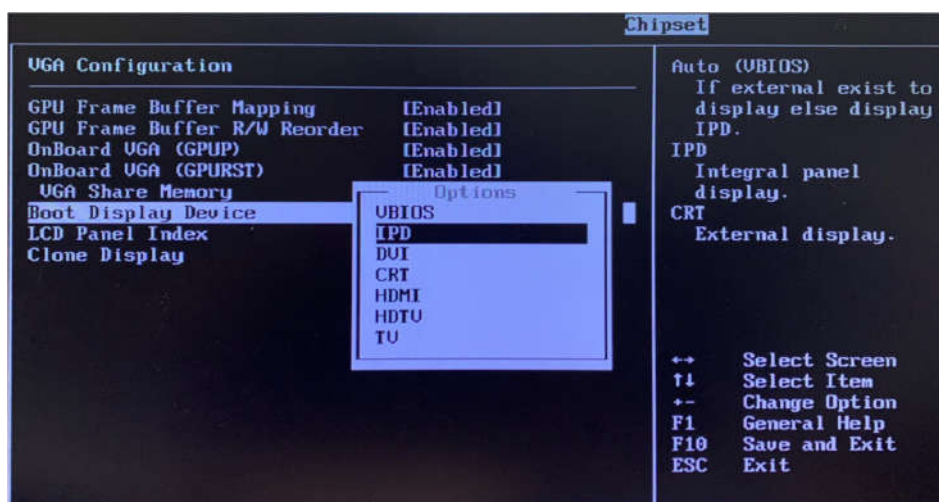

5.2 Pin Assignment of LVDS

Please refer Page 21 for LVDS pin assignment.

5.3 Basic BIOS Setting for LCD

If you would like to use LCD panel with VDX3-ETX-V2, please follow below instruction:

Boot Display Device [IPD]

LCD Panel Index according to your LCD resolution from 1 to 5.

Options	Resolution of the LCD Panel
1	640 x 480
2	800 x 480
3	800 x 600
4	1024 x 600
5	1024 x 768

Path of Boot Display Device setting:

Chipset > NorthBridge Configuration > VGA Configuration > Boot Display Device [IPD]

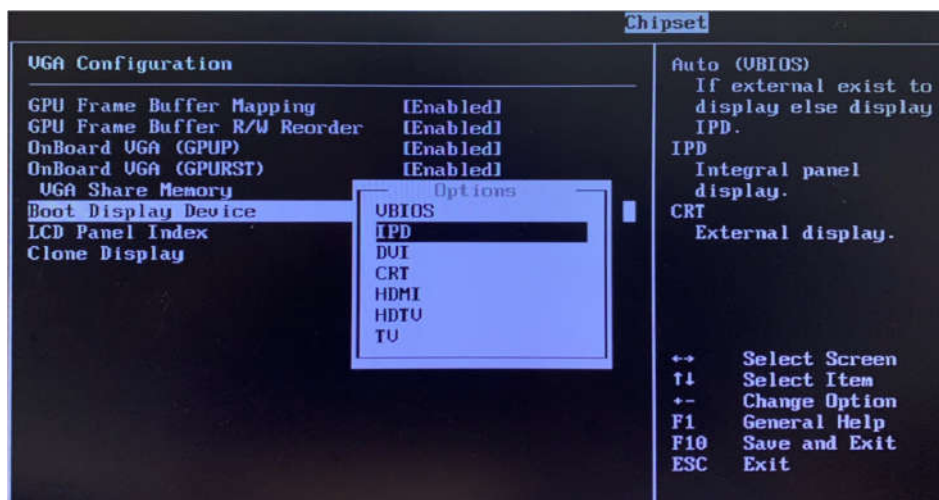

Path of LCD Panel Index setting:

Chipset > NorthBridge Configuration > VGA Configuration >
LCD Panel Index []

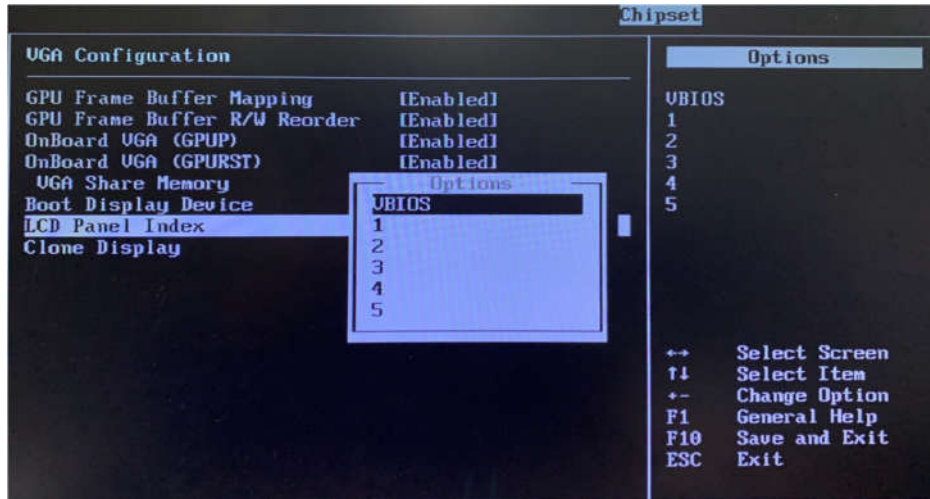

Technical Support Directly

To offer you more accurate and specific solutions for the technical situations you have, please prepare the information below before contacting :

- Product name and serial number
- Description of the H/W environment (i.e.: working temperature, I/O board information, information of connection between main board and IO boards, and/or other devices, etc)
- Description of the S/W environment (i.e: operating system, version, application software, and/or other related information, etc.)
- A detailed description and photos of the technical situation
- Any complement or technical situations you want more focusing on

User Manual Feedback

To make this user manual more complete, if you have any comments or feedbacks to this manual, please feel free to write to your

Appendix

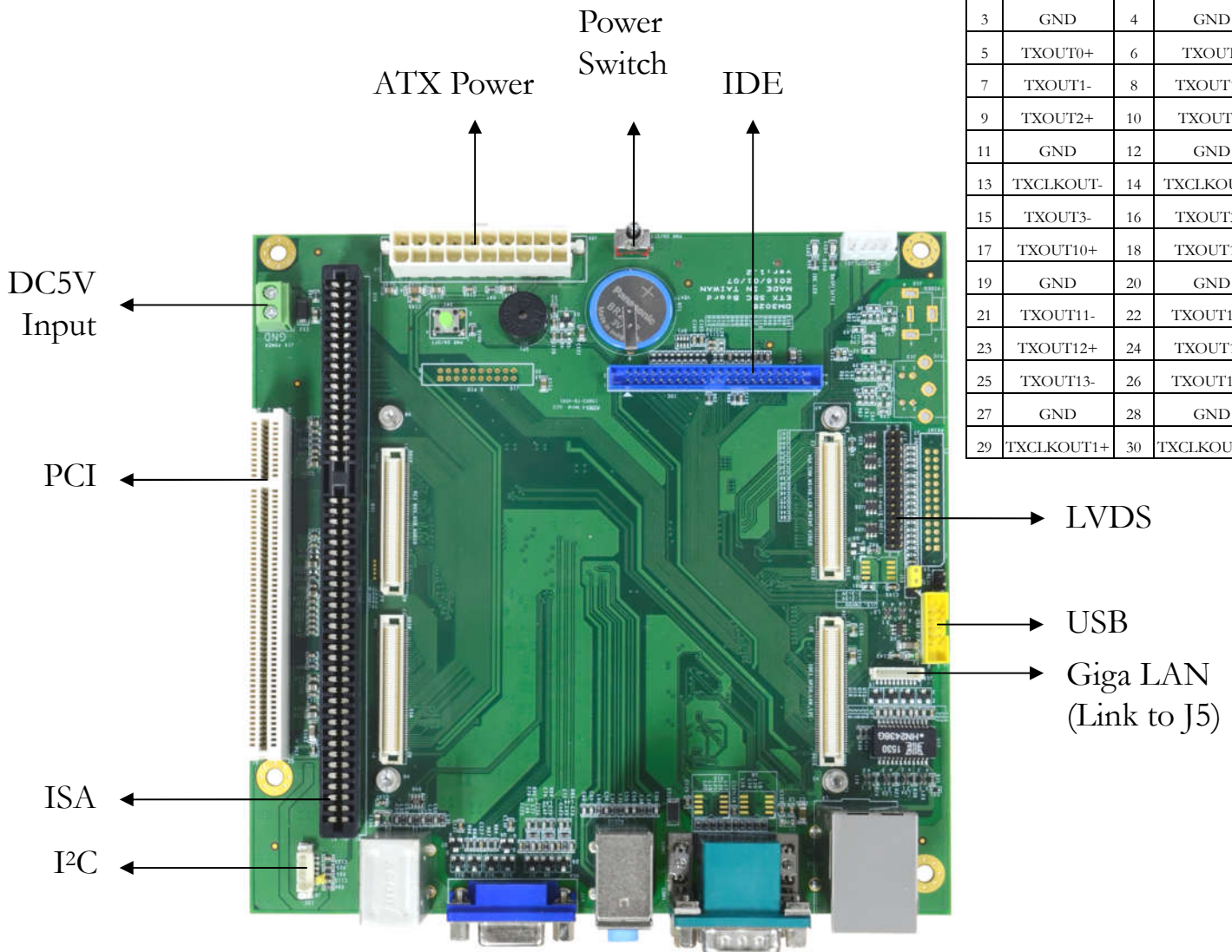

LVDS Pin Assignment:

1	VCC3	2	VCC3
3	GND	4	GND
5	TXOUT0+	6	TXOUT-
7	TXOUT1-	8	TXOUT1+
9	TXOUT2+	10	TXOUT2-
11	GND	12	GND
13	TXCLKOUT-	14	TXCLKOUT+
15	TXOUT3-	16	TXOUT3+
17	TXOUT10+	18	TXOUT10-
19	GND	20	GND
21	TXOUT11-	22	TXOUT11+
23	TXOUT12+	24	TXOUT12-
25	TXOUT13-	26	TXOUT13+
27	GND	28	GND
29	TXCLKOUT1+	30	TXCLKOUT1+

I2C Pin Assignment:

1	VCC
2	GND
3	I2CLK
4	I2DAT
5	NC
6	VCC3



Warranty

This product is warranted to be in good working order for a period of one year (12 months) from the date of purchase. Should this product fail to be in good working order at any time during this period, we will, at our option, replace or repair it without additional charge except as set forth in the following terms. This warranty does not apply to products damaged by misuse, modifications, accident or disaster. Vendor assumes no liability for any damages, lost profits, lost savings or any other incidental or consequential damage resulting from the use, misuse of, originality to use this product. Vendor will not be liable for any claim made by any other related party. Return authorization must be obtained from the vendor before returned merchandise is accepted. Authorization can be obtained by calling or faxing the vendor and requesting a Return Merchandise Authorization (RMA) number. Returned goods should always be accompanied by a clear problem description. Should you have questions about warranty and RMA service, please contact us directly.