

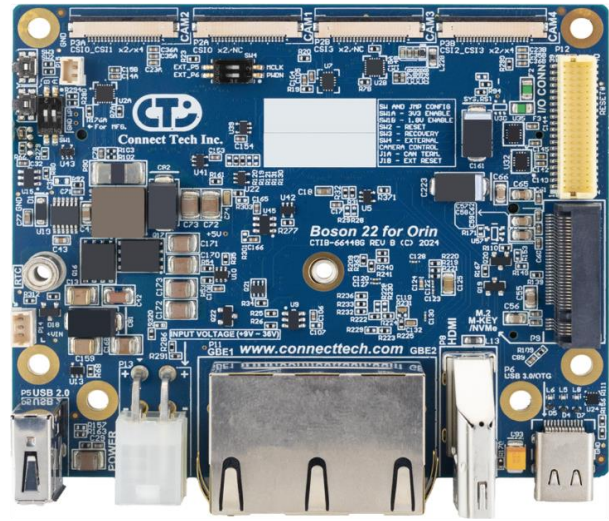

Connect Tech Inc.
Embedded Computing Experts

USERS GUIDE

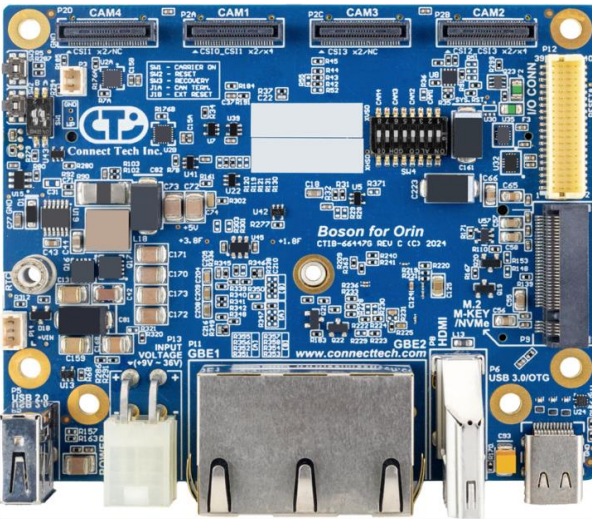

Boson/ Boson 22 for Orin

CTIM-00095 Revision 0.01 2024-04-23

CONNECT TECH

www.connecttech.com

support@connecttech.com

TABLE OF CONTENTS

Table of Contents	2
Preface	4
Disclaimer	4
Customer Support Overview	4
Contact Information	4
Limited Product Warranty.....	5
Copyright Notice	5
Trademark Acknowledgment	5
ESD Warning	6
Revision History	6
Introduction	7
Product Features and Specifications.....	8
Part Numbers / Ordering Information	9
Product Overview	9
Block Diagram	9
Connector and Switch Locations.....	10
Top side (NGX020).....	10
Bottom side (NGX020)	11
TOP Side (NGX021)	12
Bottom side (NGX021)	13
Connector Summary.....	14
Switch and Jumper Summary.....	15
Detailed Feature Description	16
NVIDIA® Jetson Orin NX™ / Nano™ and Module Connector.....	16
FAN Connector	17
HDMI Connector.....	17
FRAMOS MIPI CSIx4 Connectors.....	18
FRAMOS MIPI CSIx2 Connector	19
22-Pin MIPI CSIx4/x2 Connector	20
22-Pin MIPI CSIx2 Connector	20
NGX020 Camera I/O Connectors	21
NGX021 Camera I/O Connectors	22
USB 3.1 w/OTG Gen 1 / 2 Type-C Connector.....	23
10/100/1000 Dual Ethernet Connector.....	23
M.2 M-key 2280 NVMe x4 Connector	24
M.2 E-key 2230 Wi-Fi/BT Connector.....	24
USB 2.0 Type-A Connector	24
Misc. I/O Connector.....	25
Power Connector	26
RTC Battery Connector.....	26
Sleep/Shutdown Wake connector.....	26
Carrier Power and Reset.....	27
Carrier Power ON.....	27
Reset Pushbutton	27
Force Recovery Pushbutton.....	28

External Camera control (for NGX021 only).....	28
Camera XVS0 and XHS0 DIP switch (for NGX020 only)	28
Jumper for CAN termination and External Reset.....	29
Typical Installation	30
Power Consumption & Thermals.....	31
NVIDIA® Jetson™ Orin™ NX	31
Current Consumption Details	31
Software / BSP Details	31
Cables (Not Included)	32
Accessories	32
Recommended Cameras	32

PREFACE

Disclaimer

The information contained within this user’s guide, including but not limited to any product specification, is subject to change without notice.

Connect Tech assumes no liability for any damages incurred directly or indirectly from any technical or typographical errors or omissions contained herein or for discrepancies between the product and the user’s guide.

Customer Support Overview

If you experience difficulties after reading the manual and/or using the product, contact the Connect Tech reseller from which you purchased the product. In most cases, the reseller can help you with product installation and difficulties.

In the event that the reseller is unable to resolve your problem, our highly qualified support staff can assist you. Our support section is available 24 hours a day, 7 days a week on our website at: <https://connecttech.com/support/resource-center/>. See the contact information section below for more information on how to contact us directly. Our technical support is always free.

Contact Information

Contact Information	
Mail/Courier	Connect Tech Inc. Technical Support 489 Clair Road West Guelph, Ontario Canada N1L 0H7
Contact Information	sales@connecttech.com support@connecttech.com www.connecttech.com Toll-Free: 800-426-8979 (North America only) Telephone: +1-519-836-1291 Facsimile: 519-836-4878 (on-line 24 hours)
Support	Please go to the Connect Tech Resource Center for product manuals, installation guides, device drivers, BSPs, and technical tips. Submit your technical support questions to our support engineers. Technical Support representatives are available Monday through Friday, from 8:30 a.m. to 5:00 p.m. Eastern Standard Time.

Limited Product Warranty

Connect Tech Inc. provides a 1-year Warranty for this product. Should this product, in Connect Tech Inc.'s opinion, fail to be in good working order during the warranty period, Connect Tech Inc. will, at its option, repair or replace this product at no charge, provided that the product has not been subjected to abuse, misuse, accident, disaster or non-Connect Tech Inc. authorized modification or repair.

You may obtain warranty service by delivering this product to an authorized Connect Tech Inc. business partner or to Connect Tech Inc. along with proof of purchase. Product returned to Connect Tech Inc. must be pre-authorized by Connect Tech Inc. with an RMA (Return Material Authorization) number marked on the outside of the package and sent prepaid, insured, and packaged for safe shipment. Connect Tech Inc. will return this product by prepaid ground shipment service.

The Connect Tech Inc. Limited Warranty is only valid over the serviceable life of the product. This is defined as the period during which all components are available. Should the product prove to be irreparable, Connect Tech Inc. reserves the right to substitute an equivalent product if available or to retract the Warranty if no replacement is available.

The above warranty is the only warranty authorized by Connect Tech Inc. Under no circumstances will Connect Tech Inc. be liable in any way for any damages, including any lost profits, lost savings, or other incidental or consequential damages arising out of the use of, or inability to use, such product.

Copyright Notice

The information contained in this document is subject to change without notice. Connect Tech Inc. shall not be liable for errors contained herein or for incidental consequential damages in connection with the furnishing, performance, or use of this material. This document contains proprietary information that is protected by copyright. All rights are reserved. No part of this document may be photocopied, reproduced, or translated to another language without the prior written consent of Connect Tech, Inc.

Copyright © 2024 by Connect Tech, Inc.

Trademark Acknowledgment

Connect Tech, Inc. acknowledges all trademarks, registered trademarks, and/or copyrights referred to in this document as the property of their respective owners. Not listing all possible trademarks or copyright acknowledgments does not constitute a lack of acknowledgment to the rightful owners of the trademarks and copyrights mentioned in this document.

ESD Warning



Electronic components and circuits are sensitive to Electrostatic Discharge (ESD). When handling any circuit board assemblies including Connect Tech COM Express carrier assemblies, it is recommended that ESD safety precautions be observed. ESD safe best practices include, but are not limited to:

- Leaving circuit boards in their antistatic packaging until they are ready to be installed.
- Using a grounded wrist strap when handling circuit boards, at a minimum you should touch a grounded metal object to dissipate any static charge that may be present on you.
- Only handling circuit boards in ESD-safe areas, which may include ESD floor and table mats, wrist strap stations, and ESD safe lab coats.
- Avoid handling circuit boards in carpeted areas.
- Try to handle the board by the edges, avoiding contact with components.

REVISION HISTORY

Revision	Date	Changes
0.00	2023-11-03	Preliminary Release
0.01	2024-04-23	Updated for Rev B of NGX021 and Rev C of NGX020 - A connector to wake from shutdown mode is added to the device.

INTRODUCTION

Boson/ Boson 22 for Orin is an AI vision powerhouse, integrating up to four MIPI cameras within an extremely small footprint. Specifically designed for use within the FRAMOS Sensor Ecosystem and Jetson™ Orin cameras, Boson maximizes sensor inputs and storage solutions for high-end vision applications. This joint product offering provides customers with a plug-and-play vision solution that accelerates application development time. Compatible with both the Jetson Orin NX™ and Orin Nano™ users can seamlessly transition between modules should their processing needs change.

Boson for Orin comes standard with software hooks in the board support package that automatically connects select cameras in the FRAMOS Sensor Module Ecosystem to NVIDIA®'s JetPack SDK, simplifying development requirements for your Software team. Boson for Orin has four FRAMOS PixelMate connectors directly on the carrier board. These connectors allow users to directly connect up to 4x 2-lane or 2x 4-lane MIPI CSI-2 cameras from the FRAMOS Sensor Module Ecosystem.

Boson 22 for Orin comes with software hooks in the board support package that connect specific cameras in the Jetson™ Orin camera Sensor Module Ecosystem to NVIDIA®'s JetPack SDK automatically. This simplifies development requirements for your software team. Boson 22 for Orin has four 22-pin MIPI connectors on the carrier board. These connectors allow users to directly connect up to four 2-lane or two 4-lane MIPI CSI-2 cameras from the FRAMOS Sensor Module Ecosystem.

While Boson/ Boson 22 for Orin is compatible with NVIDIA® Jetson Orin NX™ and Orin Nano™, some I/O availability will change across modules. View the [Boson/ Boson 22 for Orin Compatibility Specifications](#) for a full breakdown.

Product Features and Specifications

These specifications are based on the **NVIDIA® Jetson Orin NX™ and Orin Nano™**.

Feature	Boson Orin for FRAMOS
Module Compatibility	NVIDIA® Jetson Orin NX™ and Orin Nano™
Ethernet ^{[1][2]}	2x 1000 BASE-T Ethernet Port <ul style="list-style-type: none"> 1x Port sourced directly from NVIDIA® Jetson™ module 1x Port sourced from i210
MIPI Camera	Supports up to the following camera configurations: <ul style="list-style-type: none"> 2x 4-lane MIPI FRAMOS Sensor Modules 4x 2-lane MIPI FRAMOS Sensor Modules
Display Output	1x HDMI 2.0
Storage	1x NVMe M.2 M-Key 2280 (4-lane PCIe)
Wireless Expansion ^{[1][2]}	1x WiFi/Bluetooth M.2 E-Key 2230 module
USB ^{[1][2]}	1x USB 3.1 Gen 2 w/ OTG capability (Type C) 1x USB 2.0 (Type A)
Input Power / Misc Power Details	+9V to +36V Input Voltage Range <ul style="list-style-type: none"> Auto-ON operation by default
RTC Battery	1x RTC Battery External Connector
Fan	1x FAN w/ PWM Control
Operating Temperature	-40°C to +85°C (-40°F to +185°F)
Dimensions	90mm x 75mm (3.54" x 2.95")
Warranty and Support	1 Year Warranty and Free Support
Misc. I/O ^{[1][2]}	3x 3.3V TTL UARTs (1x CONSOLE) 8x GPIOs 3.3V TTL (2x PWM Capable) 2x I2C 3.3V 1x CAN 2.0b 2x SPI 2x 3.3V 2x 5V 8x GND

[1] Please review the [Boson for Orin Compatibility Specifications](#) for a full breakdown of feature differences between the NVIDIA Jetson Orin NX™ and Orin Nano™.

[2] Please review the [Boson 22 for Orin Compatibility Specifications](#) for a full breakdown of feature differences between the NVIDIA Jetson Orin NX™ and Orin Nano™.

Part Numbers / Ordering Information

Part Number	
NGX020	Boson for Orin Carrier Board
NGX021	Boson 22 for Orin Carrier Board

Note: Please refer CTI website for different NGX020/ NGX021 sub-configurations.

PRODUCT OVERVIEW

Block Diagram

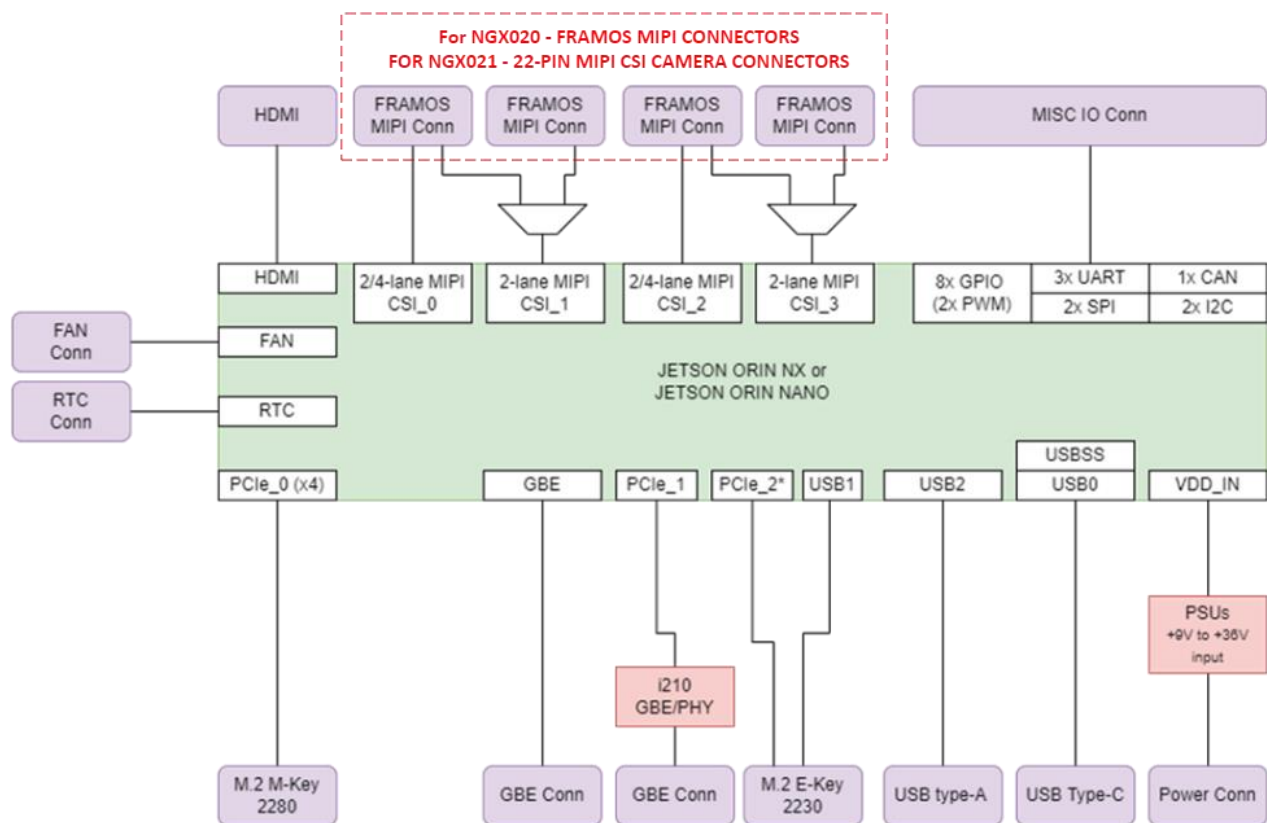

Connector and Switch Locations

Top side (NGX020)

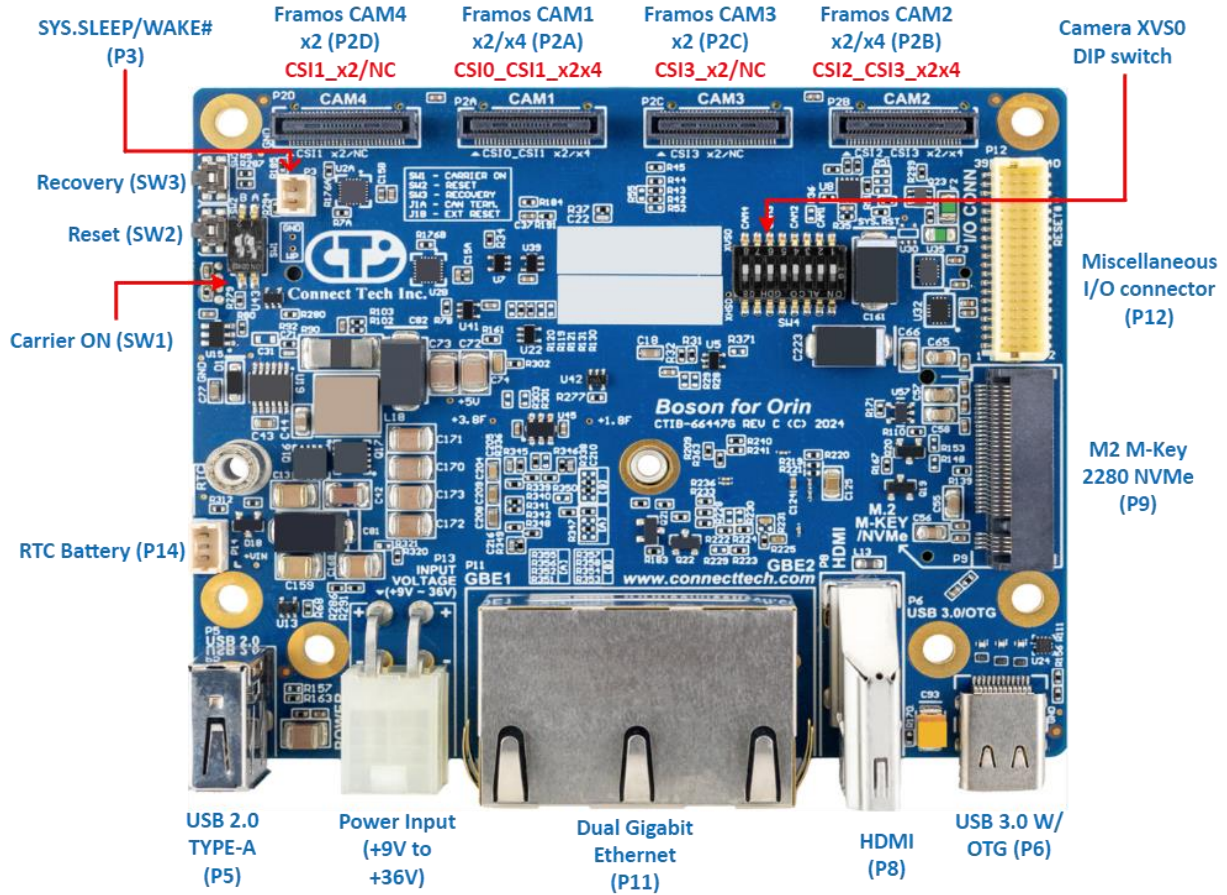

Note: The silkscreen labels of camera connectors for NGX020 Rev. A are incorrect. Please follow the image above for proper connectivity

Bottom side (NGX020)

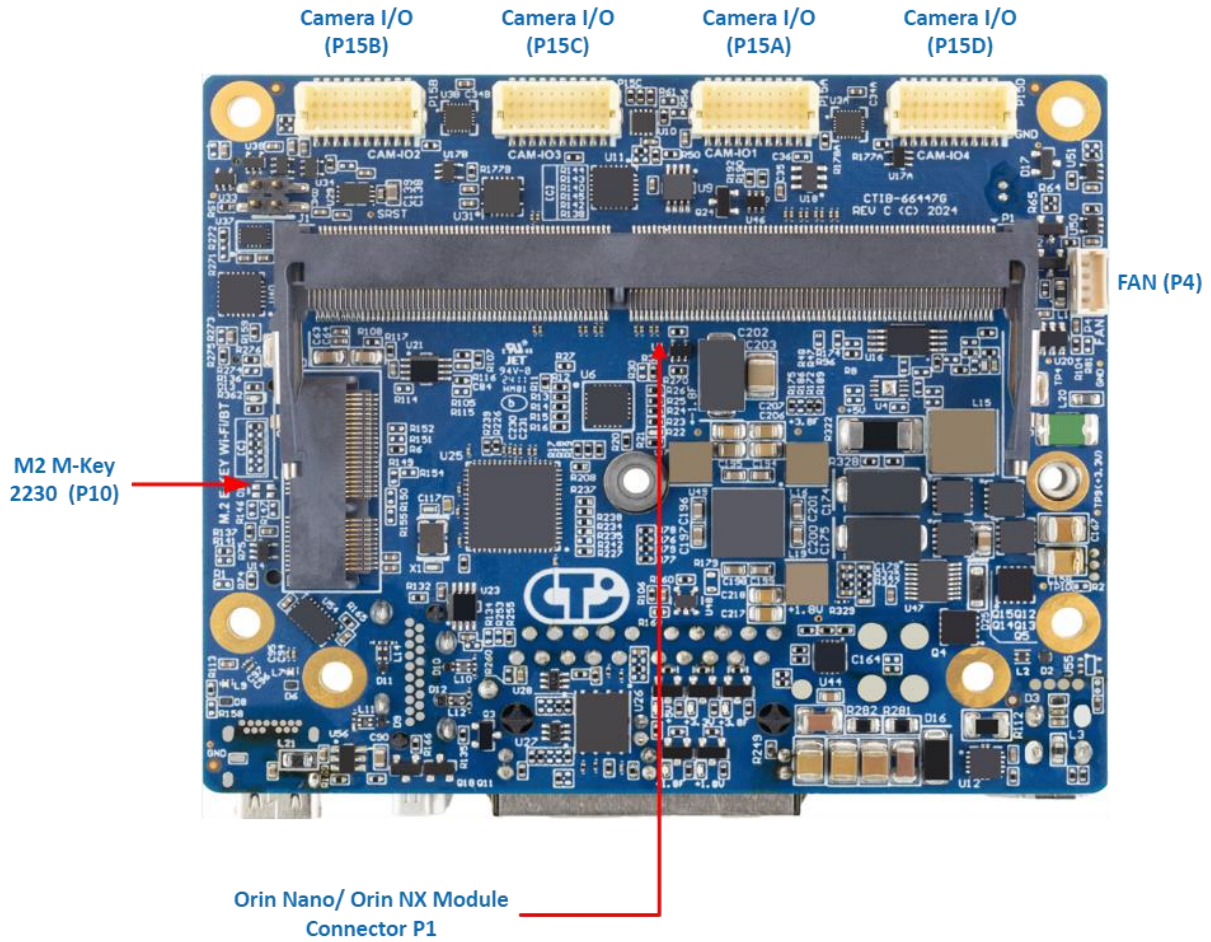

TOP Side (NGX021)

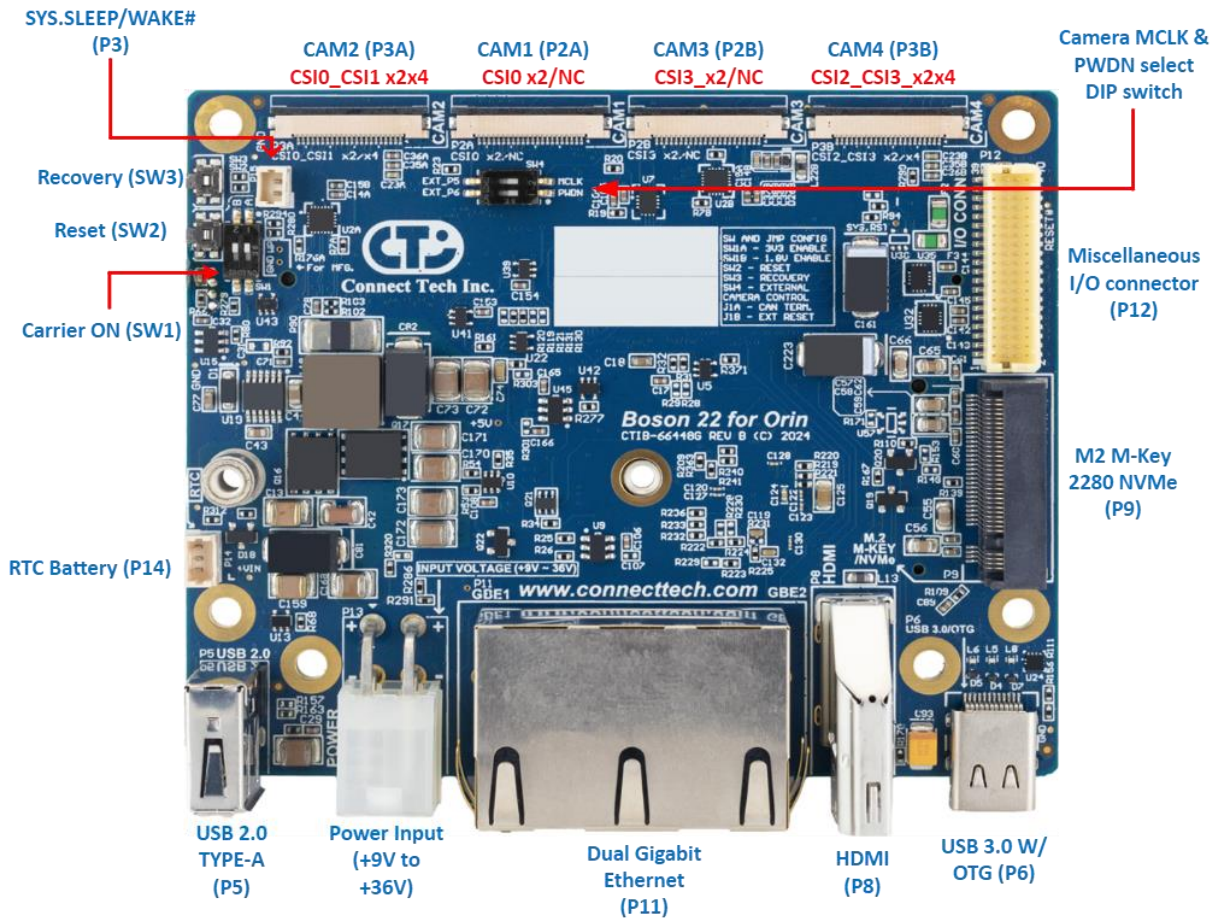

Bottom side (NGX021)

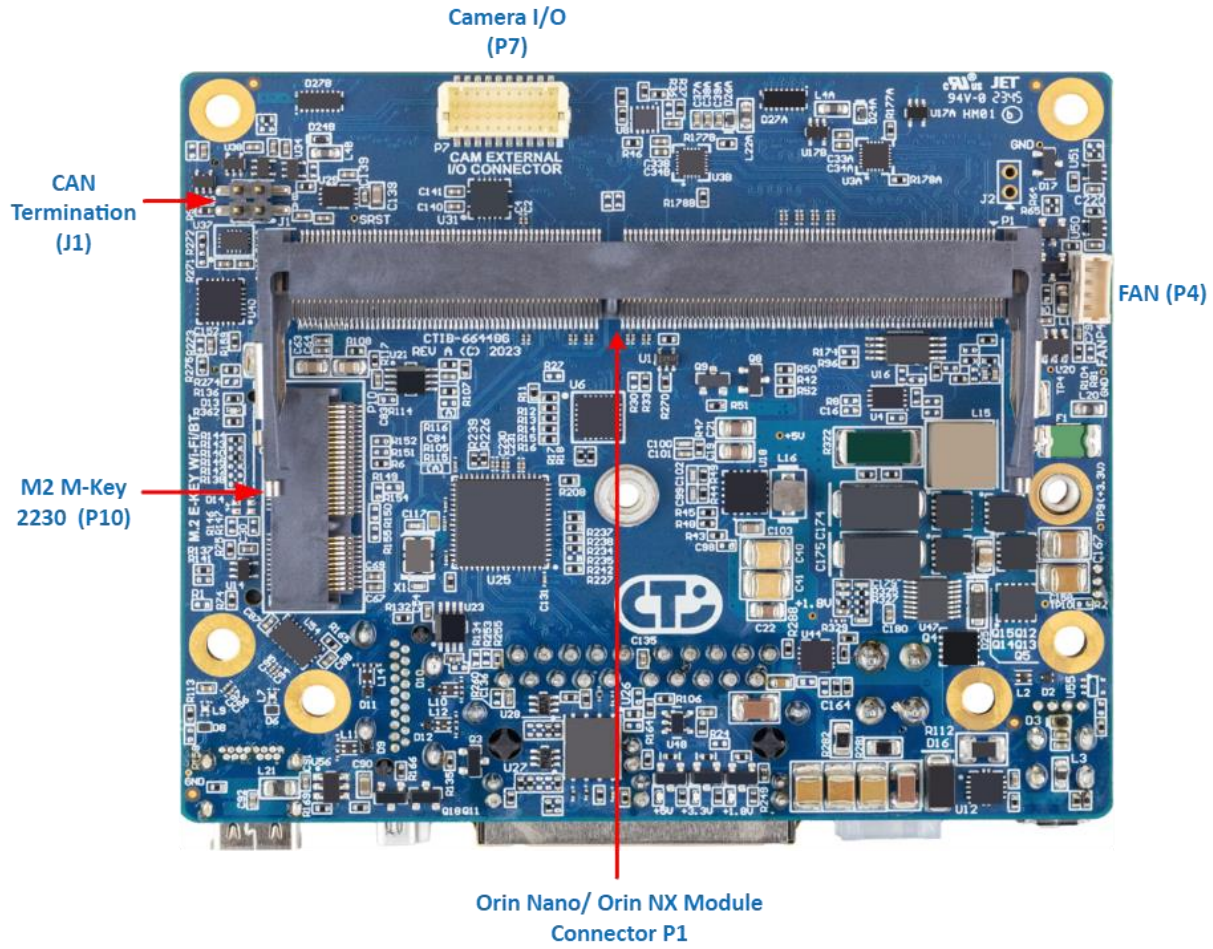

Connector Summary

Designator	Carrier	Connector	Description
P1	NGX020/021	Jetson Orin NX™ / Orin Nano™ connector	NVIDIA® Jetson Orin NX™ / Orin Nano™ Module Board-To-Board Connector
P2A, P2B, P2C, P2D	NGX020	MIPI CSI x4 connectors by FRAMOS	FRAMOS MIPI CSI x4/x2 Connector for NGX020
P2A, P2B, P3A, P3B	NGX021	22 Pin MIPI CSI x4 connectors	22-Pin MIPI CSI x4/x2 Connector for NGX021
P4	NGX020/021	Fan connector	Active heatsink fan Connector for Jetson Orin NX™ / Orin Nano™
P5	NGX020/021	USB 2.0	USB2.0 Type-A Connector
P6	NGX020/021	USB 3.1 OTG	USB 3.1 Type-C Connector with OTG
P7	NGX021	Camera I/O connectors DF20EG-20DP-1V (52)	I/O Connectors for 22-pin MIPI camera signals for NGX021
P8	NGX020/021	HDMI	HDMI Video Connector
P9	NGX020/021	M.2 M-key slot	M.2 2280 M-Key NVMe SSD Connector
P10	NGX020/021	M.2 E-key slot	M.2 2230 E-Key Wi-Fi/Bluetooth Module Connector
P11	NGX020/021	Dual Gigabit Ethernet	Dual RJ-45 Gigabit Ethernet Connector 10/100/1000 Base-T connection
P12	NGX020/021	Misc. I/O Connector DF20G-40DP-1V (56)	Miscellaneous I/O connector. UART, SPI, I2C, GPIOs (w/ 2x PWM), CAN
P13	NGX020/021	Power input connector 0353180420	+9V to +36V Mini-Fit Jr. 4-Pin DC Power Input Connector
P14	NGX020/021	RTC battery 53047-0310	RTC Battery Connector
P15A, P15B, P15C, P15D	NGX020	Camera I/O connectors DF20EG-20DP-1V (52)	I/O Connectors for FRAMOS camera signals for NGX020
P3	NGX020 Rev. C onwards	Power Wake-up connector	Power wake-up connector to wake from shutdown/Sleep mode
P15	NGX021 Rev. B onwards		

Switch and Jumper Summary

Designator	Carrier	Function	Description
SW1	NGX020/021	Carrier Power ON with no module	Do not use, tests use only (DIP switch for Carrier Power ON with no module)
SW2	NGX020/021	Reset push button	Reset Pushbutton, press to initiate a reset
SW3	NGX020/021	Force Recovery pushbutton	Force Recovery Pushbutton, press to initiate recovery mode and flash a new image via USB OTG
J1-A J1-B	NGX020/021	CAN termination jumper External Reset TMM-102-01-L-D-SM	J1-A: CAN Termination. Populate jumper to add termination J1-B: External reset
SW4	NGX020	FRAMOS Camera XVS0 Selection	FRAMOS Camera XVS0 and XHS0 Selection 8 Position SPST DIP switch for NGX020
SW4	NGX021	MIPI Camera external MCLK and PWDN Selection	MIPI Camera external MCLK and PWDN Selection 2 Position SPST DIP switch for NGX021

DETAILED FEATURE DESCRIPTION

NVIDIA® Jetson Orin NX™ / Nano™ and Module Connector

The NVIDIA® Jetson™ SoM is connected to the Boson/ Boson 22 for Orin carrier board via a TE Connectivity DDR4 SODIMM 260 Pin connector.

Function	Description
Location	P1
Type	Module Connector
Pinout	Refer to NVIDIA® Module Datasheets.
Features	Refer to NVIDIA® Module Datasheets.



NVIDIA® Jetson™ Orin™ NX

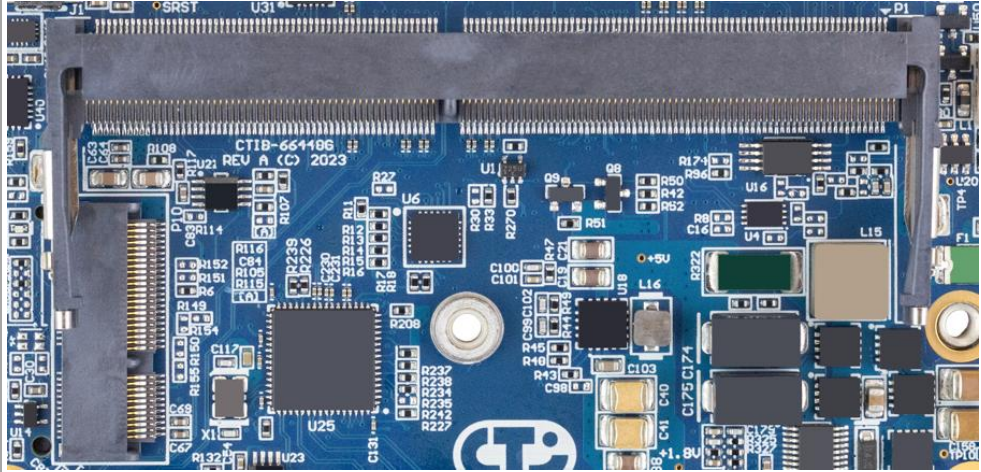

SO DIMM connector for module

FAN Connector

Boson/ Boson 22 for Orin implements a 4-position Molex PicoBlade connector for active cooling capability.

Function	Description	
Location	P4	
Type	Fan Connector Molex 4 Position 1.25mm PicoBlade Connector	
Carrier Connector	Part Number: 53047-0410 Manufacturer: Molex	
Mating Connector	Molex 0510210400 PicoBlade Connector	
Pinout	Pin	Description
	1	GND
	2	+5V_FAN
	3	FAN_TACH
	4	FAN_PWM

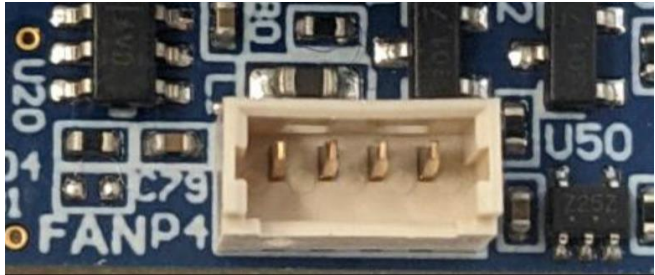

HDMI Connector

The NVIDIA® Jetson Orin NX™ and Orin Nano™ modules will output video via the Boson/ Boson 22 for Orin Right Angle HDMI connector that is HDMI 2.0 capable.

Function	Description
Location	P8
Type	HDMI Right Angle Connector
Mating Connector	HDMI Type-A Cable
Pinout	Refer to HDMI Standard

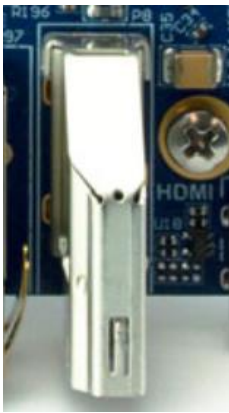

FRAMOS MIPI CSIx4 Connectors

The Boson for Orin carrier board allows FRAMOS MIPI CSIx4/CSIx2 video through the DF40HC(4.0)-60DS-0.4V(51) connectors.

Function	Description			
Location	P2A, B			
Type	FRAMOS MIPI CSIx4/x2 Connector (60-pin)			
Mating Connector	Mating connector: DF40C-60DP-0.4V(51) Flex cable: FMAFC-150/60			
Pinout	Pin	Description	Pin	Description
	1	+3.8V	2	+1.8V
	3	+3.8V	4	+1.8V
	5	NC	6	NC
	7	NC	8	NC
	9	NC	10	NC
	11	GND	12	GND
	13	GND	14	GND
	15	CAM_RST_0	16	CAM_RST_1
	17	CAM_GPIO14	18	CAM_GPIO15 (SPI_MISO)
	19	CAM_GPIO0(XMASTER0)	20	CAM_GPIO8
	21	SCL_A (I2C_0_SCL)	22	SCL_B (I2C_1_SCL)
	23	CAM_GPIO17(SPI_CS)	24	CAM_GPIO16 (SYS_PW_EN)
	25	XVS0	26	CAM_GPIO9
	27	SDA_A (I2C_0_SDA)	28	SDA_B (I2C_1_SDA)
	29	XHS0 (CAM_GPIO2)	30	CAM_GPIO10
	31	XTRIG0 (CAM_GPIO3)	32	CAM_GPIO11 (FSTROBE)
	33	CAM_PW_EN_0	34	CAM_PW_EN_1
	35	CAM_GPIO6	36	CAM_GPIO7
	37	GND	38	GND
	39	MCLK_0	40	CAM_GPIO4 (MCLK2)
	41	MCLK_1	42	CAM_GPIO5 (MCLK3)
	43	GND	44	GND
	45	ALTCLK_P	46	DATA3_P
	47	ALTCLK_N	48	DATA3_N
	49	GND	50	GND
	51	DATA0_N	52	DATA1_N
	53	DATA0_P	54	DATA1_P
	55	GND	56	GND
	57	DATA2_P	58	CSI_CLK_P
	59	DATA2_N	60	CSI_CLK_N

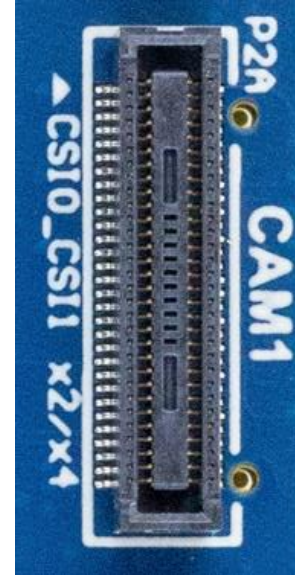

FRAMOS MIPI CSIx2 Connector

Boson for Orin carrier board allows FRAMOS MIPI CSIx2 video through the DF40HC(4.0)-60DS-0.4V(51) connectors.

Function	Description			
Location	P2C, D			
Type	FRAMOS MIPI CSIx2/NC Connector (60-pin)			
Mating Connector	Mating connector: DF40C-60DP-0.4V(51) Flex cable: FMAFC-150/60			
Pinout	Pin	Description	Pin	Description
	1	+3.8V	2	+1.8V
	3	+3.8V	4	+1.8V
	5	NC	6	NC
	7	NC	8	NC
	9	NC	10	NC
	11	GND	12	GND
	13	GND	14	GND
	15	CAM_RST_0	16	NC
	17	NC	18	NC
	19	NC	20	NC
	21	SCL_A (I2C_0_SCL)	22	SCL_B (I2C_1_SCL)
	23	NC	24	NC
	25	XV50	26	NC
	27	SDA_A (I2C_0_SDA)	28	SDA_B (I2C_1_SDA)
	29	XHS0 (CAM_GPIO2)	30	NC
	31	NC	32	NC
	33	CAM_PW_EN_0	34	CAM_PW_EN_1
	35	NC	36	NC
	37	GND	38	GND
	39	MCLK_0	40	NC
	41	MCLK_1	42	NC
	43	GND	44	GND
	45	NC	46	NC
	47	NC	48	NC
	49	GND	50	GND
	51	DATA0_N	52	DATA1_N
	53	DATA0_P	54	DATA1_P
	55	GND	56	GND
	57	NC	58	CLK_P
	59	NC	60	CLK_N

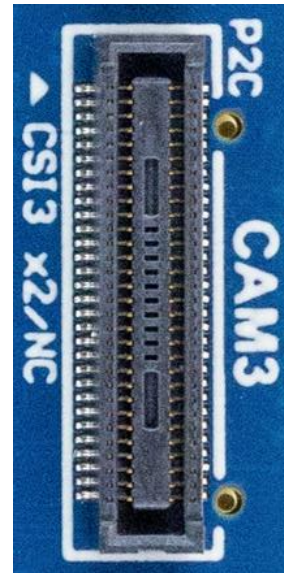
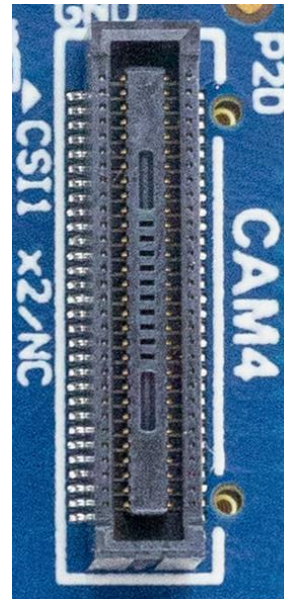

22-Pin MIPI CSIx4/x2 Connector

Boson 22 for Orin carrier board allows 22-Pin MIPI CSIx4/x2 video through the 54548-2271 connectors.

Function	Description			
Location	P3A, P3B			
Type	22-Pin MIPI CSIx4/x2 Connector (22-pin)			
Mating Connector	Mating connector: 54548-2271 (Molex) Flex cable: NA			
Pinout	Pin	Description	Pin	Description
	1	+3.3V	12	CSIB_D2_N
	2	CAMA_SDA	13	GND
	3	CAMA_SCL	14	CSIA_CLK_P
	4	GND	15	CSIA_CLK_N
	5	CAMA_MCLK	16	GND
	6	CAMA_PWDN	17	CSIA_D1_P
	7	GND	18	CSIA_D1_N
	8	CSIB_D3_P	19	GND
	9	CSIB_D3_N	20	CSIA_D0_P
	10	GND	21	CSIA_D0_N
	11	CSIB_D2_P	22	GND



22-Pin MIPI CSIx2 Connector

Boson 22 for Orin carrier board allows 22-Pin MIPI CSIx2 video through the 54548-2271 connectors.

Function	Description			
Location	P3A, P3B			
Type	22-Pin MIPI CSIx4/x2 Connector (22-pin)			
Mating Connector	Mating connector: 54548-2271 (Molex) Flex cable: NA			
Pinout	Pin	Description	Pin	Description
	1	+3.3V	12	NC
	2	CAMB_SDA	13	GND
	3	CAMB_SCL	14	CSIB_CLK_P
	4	GND	15	CSIB_CLK_N
	5	CAMB_MCLK	16	GND
	6	CAMB_PWDN	17	CSIB_D1_P
	7	GND	18	CSIB_D1_N
	8	NC	19	GND
	9	NC	20	CSIB_D0_P
	10	GND	21	CSIB_D0_N
	11	NC	22	GND



NGX020 Camera I/O Connectors

The Boson for Orin carrier board allows for access to FRAMOS camera I/O signals and power rails through DF20EG-20DP-1V(52) connectors.

Function	Description			
Location	P15A, P15B, P15C, P15D			
Type	I/O Connector for FRAMOS camera signals Hirose 20 Position 1 mm Connector			
Carrier Connector	Part Number: DF20EG-20DP-1V(52) Manufacturer: Hirose Electric Co Ltd			
Mating Connector	Mating connector: DF20A-20DS-1C			
Pinout	Pin	Description	Pin	Description
	1	+3.8V	2	+1.8V
	3	GPIO14	4	RST_1
	5	GPIO0 (XMASTER0)	6	GPIO15 (SPI_MISO)
	7	GPIO17 (SPI_CS)	8	GPIO8
	9	GPIO9	10	GPIO16 (SYS_PW_EN)
	11	GPIO2 (XHS0)	12	GPIO10
	13	GPIO3 (XTRIG0)	14	GPIO11 (FSTROBE)
	15	GPIO6	16	GPIO7
	17	GPIO1 (XVS0)	18	GPIO4 (MCLK2)
	19	GND	20	GND

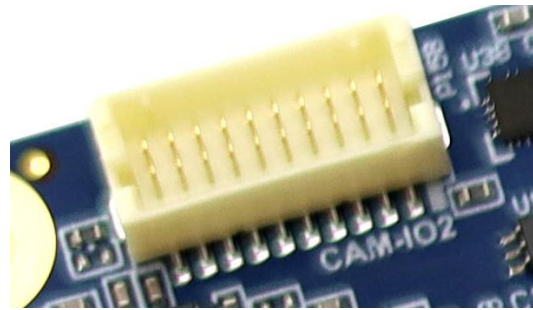

NGX021 Camera I/O Connectors

The Boson 22 for Orin carrier board allows for access to 22-Pin MIPI camera I/O signals and power rails through DF20EG-20DP-1V(52) connectors.

Function	Description			
Location	P7			
Type	I/O Connector for external MIPI camera signals Hirose 20 Position 1 mm Connector			
Carrier Connector	Part Number: DF20EG-20DP-1V(52) Manufacturer: Hirose Electric Co Ltd			
Mating Connector	Mating connector: DF20A-20DS-1C			
Pinout	Pin	Description	Pin	Description
	1	+3.3V	2	+3.3V
	3	NC	4	CAM0_MCLK/TRIGGER
	5	NC	6	CAM0_PWDN/FLASH
	7	NC	8	CAM1_MCLK/TRIGGER
	9	NC	10	CAM1_PWDN/FLASH
	11	NC	12	CAM2_MCLK/TRIGGER
	13	NC	14	CAM2_PWDN/FLASH
	15	NC	16	CAM3_MCLK/TRIGGER
	17	NC	18	CAM3_PWDN/FLASH
	19	GND	20	GND



USB 3.1 w/OTG Gen 1 / 2 Type-C Connector

Boson/ Boson 22 for Orin incorporates a USB 3.1 Gen 1 / 2 Type-C Connector with a 2A current limit. Allows host mode access to the module or OTG flashing of the module.

Function	Description
Location	P6
Type	USB Type-C Connector w/ OTG
Mating Connector	USB Type-C Cable
Pinout	Refer to USB Standard

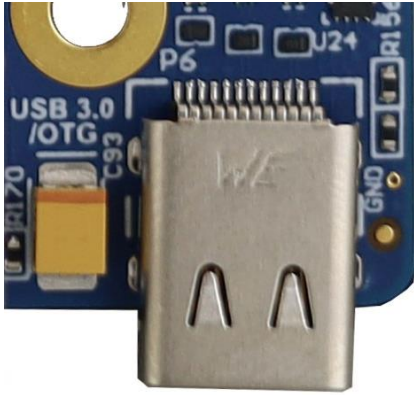

Note: If using the Jetson Orin NX™ Module, USB 3.1 Gen 2 is the fastest speed available to this connector.

10/100/1000 Dual Ethernet Connector

Boson/ Boson 22 for Orin includes a Dual RJ-45 ethernet connector for internet communication. One RJ45 Ethernet port is directly connected to the module while the other is through a PCIe Gigabit Ethernet PHY.

Function	Description
Location	P11
Type	2x RJ-45 Connector
Mating Connector	RJ-45 Ethernet Cable
Pinout	Refer to Ethernet Standard



Misc. I/O Connector

Boson/ Boson 22 for Orin implements a Hirose DF20G-40DP-1V(56) Connector to allow for additional user control. 2x SPI (SPI0, SPI1), 3x UART (UART0, UART1, UART2 – DEBUG), 2x I2C (I2C0, I2C1), 1x CAN, 6x GPIO (From I2C Expander), and 2x PWM (GPIO07 From Module, GPIO13 From Module).

Function	Description					
Location	P12					
Type	Misc. I/O Expansion Connector					
Carrier Connector	DF20G-40DP-1V(56)					
Mating Connector	DF20A-40DS-1C					
Pinout	Pin	Description	I/O Type	Pin	Description	I/O Type
	1	+5V	Power	2	SPI0_MOSI (3.3V Max.)	O
	3	SPI0_MISO (3.3V Max.)	I	4	SPI0_SCK (3.3V Max.)	O
	5	SPI0_CS0# (3.3V Max.)	O	6	+3.3V	Power
	7	GND	Power	8	SPI1_MOSI (3.3V Max.)	O
	9	SPI1_MISO (3.3V Max.)	I	10	SPI1_SCK (3.3V Max.)	O
	11	SPI1_CS0# (3.3V Max.)	O	12	GND	Power
	13	UART2_TX (3.3V Max., Console)	O	14	UART2_RX (3.3V Max., Console)	I
	15	GND	Power	16	I2C0_SCL (3.3V Max.)	I/O
	17	I2C0_SDA (3.3V Max.)	I/O	18	GND	Power
	19	GPIO0 (3.3V Max.)	I/O	20	GPIO1 (3.3V Max.)	I/O
	21	GND	Power	22	GPIO2 (3.3V Max.)	I/O
	23	GPIO3 (3.3V Max.)	I/O	24	GPIO4 (3.3V Max.)	I/O
	25	GPIO5 (3.3V Max.)	I/O	26	GND	Power
	27	UART0_RX (3.3V Max.)	I	28	I2C1_SCL (3.3V Max.)	I/O
	29	GND	Power	30	UART0_TX (3.3V Max.)	O
	31	CANH	I/O	32	CANL	I/O
	33	GPIO07 (PWM1, 3.3V Max.)	I/O	34	GPIO13 (PWM2, 3.3V Max.)	I/O
	35	+5V	Power	36	UART1_TX (3.3V Max.)	O
	37	UART1_RX (3.3V Max.)	I	38	+3.3V	Power
	39	I2C1_SDA (3.3V Max.)	I/O	40	GND	Power

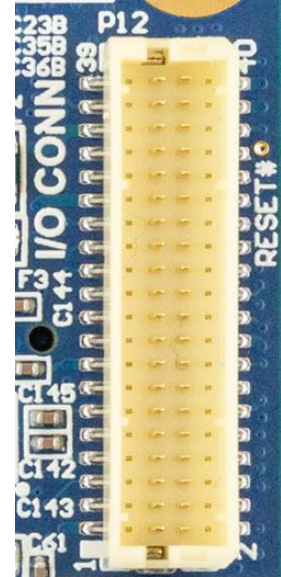

Power Connector

Boson/ Boson 22 for Orin implements a Mini-Fit Jr. 4-Pin Power Connector that accepts +9V to +36V DC power.

Function	Description	
Location	P13	
Type	Mini-Fit Jr. 4-Pin Connector	
Minimum Input Voltage	+9V DC	
Maximum Input Voltage	+36V DC	
	Pin	Description
	1	GND
	2	GND
	3	+VIN
4	+VIN	

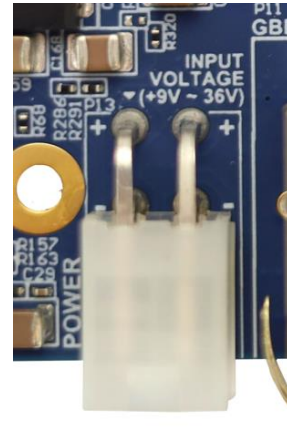

RTC Battery Connector

Function	Description	
Location	P14	
Type	1x3 TH 1.25mm (Molex-PicoBlade) connector	
Pin	Description	
	1	VCC_RTC
	2	NC
	3	GND



Sleep/Shutdown Wake connector

Function	Description	
Location	P3 (NGX020), P15 (NGX021)	
Type	1x2 TH 1.25mm (Molex-PicoBlade) connector	
Pin	Description	
	1	SYS.SLEEP/WAKE#
	2	GND

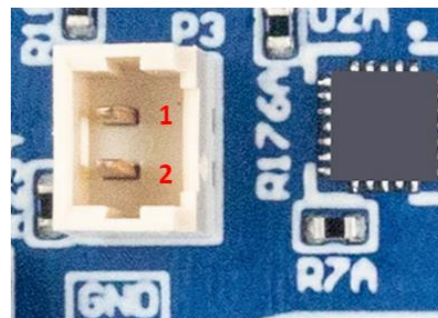

Carrier Power and Reset

Carrier Power ON

Case 1: no module connected

Boson/ Boson 22 for Orin allows for the platform to have the carrier's power rails turned ON when no Jetson™ NVIDIA® module is connected. To enable this, move the DIP switches (SW1A and SW1B) to the ON position.

Case 2: Jetson™ NVIDIA® module is connected

Boson/ Boson 22 for Orin allows for the platform to have the carrier's power rails turned OFF when Jetson™ NVIDIA® module is connected. To enable this, move the DIP switches (SW1A and SW1B) to the OFF position.

Note: Issuing a shutdown command will power off the system completely. A full power cycle will be necessary to restart carrier power.

Function	Description
Location	SW1
Type	2 position DIP switch
SW1A	+3.3V Power Rail enable/disable Move switch to turn ON +3.3V power rail, when no module is connected
SW1B	+3.8V and +1.8V Power Rails enable/disable Move switch to turn ON +3.8V and 1.8V power rails, when no module is connected

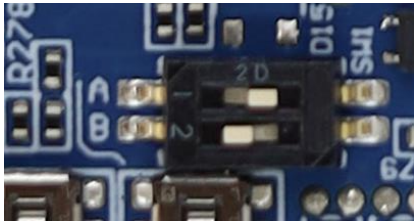

Reset Pushbutton

Boson/ Boson 22 for Orin implements a RESET pushbutton. Push this button to initiate reset sequence.

Function	Description
Location	SW2
Type	Pushbutton



Force Recovery Pushbutton

Boson/ Boson 22 for Orin implements a FORCE RECOVERY pushbutton. This is required for flashing a new image on to the SoM.

To put into Force Recovery mode, hold down the Force Recovery button and push-release the RESET button while still holding down the Force Recovery. Now release Force Recovery button.

Function	Description	
Location	SW3	
Type	Pushbutton	

External Camera control (for NGX021 only)

Boson 22 for Orin implements a 2 position DIP Switch for the selection between external and internal MIPI Cameras camera control and synchronization signals (MCLK/TRIGGER and PWDN/FLASH).

Default setting: All switches are in OFF position. MCLK and PWDN signals for cameras are provided by Jetson™ Orin or NX module.

For **external control and sync signals (Trigger and Flash)** for the cameras, DIP switches for the MCLK and PWDN of the cameras of interest can be put in the ON position to EXT_P5 and EXT_P6.

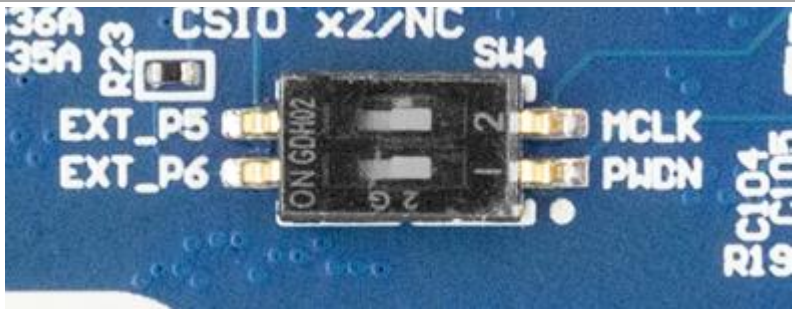
Function	Description	
Location	SW4	
Type	2 position DIP switch	

Camera XVS0 and XHS0 DIP switch (for NGX020 only)

Boson for Orin implements an 8 position DIP Switch for the selection of different FRAMOS Camera XVS0 and XHS0 signals for camera synchronization.

Default setting: All switches are in OFF position. XVS0 and XHS0 signals from all cameras are unconnected.

For **external sync or slave mode sync** for the cameras, DIP switches for the XVS0 and XHS0 of the cameras of interest can be put in the ON position.

When in the XVS0 DIP switches are in the ON position, the XVS0 signals of the cameras of interest get connected to each other and to GPIO01 of the Jetson™ Orin or NX module.

Similarly, in the ON position of the XHS0 DIP switches, the XHS0 signals of the cameras of interest get connected to each other.

Function	Description			
Location	SW4			
Type	8-position DIP switch			
Pinout	Pin	Description	Pin	Description
	1	CAM0_XVS0	2	XVS0
	3	CAM0_XHS0	4	XHS0
	5	CAM1_XVS0	6	XVS0
	7	CAM1_XHS0	8	XHS0
	9	CAM2_XVS0	10	XVS0
	11	CAM2_XHS0	12	XHS0
	13	CAM3_XVS0	14	XVS0
	15	CAM3_XHS0	16	XHS0

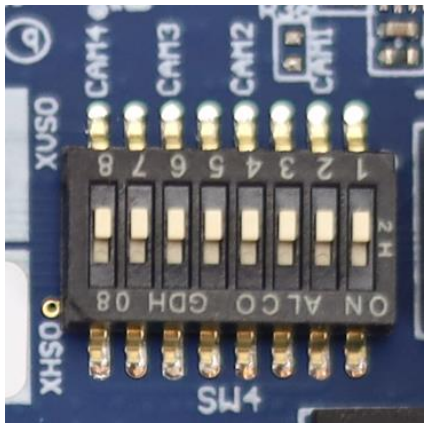

Jumper for CAN termination and External Reset

Boson/ Boson 22 for Orin implements a 2 position Jumper for Enabling or Disabling the CAN Termination Resistor of 120Ω and a location for external RESET.

Function	Description
Location	J1
Type	Jumper
J1A	CAN Termination Enable/Disable Populate jumper to enable 120Ω termination
J1B	External RESET. Place jumper to put the carrier in permanent RESET. Or use it as a location to connect an external push button.

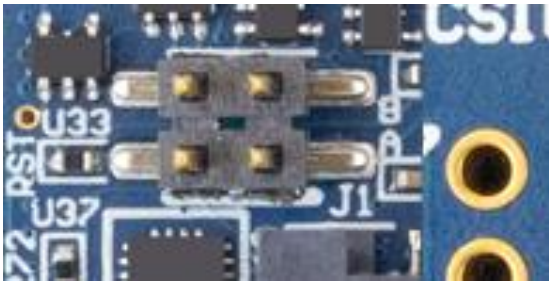

TYPICAL INSTALLATION

1. Ensure all external system power supplies are off and disconnected.
2. Install the necessary cables for your application. At a minimum, these would include:
 - a. Power cable to the input power connector.
 - b. Ethernet cable into its port (if applicable).
 - c. HDMI video display cable (if applicable).
 - d. Keyboard, Mouse, etc. via USB (if applicable).
 - e. FRAMOS /MIPI Camera(s) (if applicable).
 - f. Misc. GPIO 40-Pin Connector (if applicable).
 - g. M.2 2230 WiFi/BT Module and Antennas for WiFi/Bluetooth (if applicable).
 - h. M.2 2280 NVMe (if applicable).
 - i. Connect the Power Cable of the +9V to +36V Power Supply to the Mini-Fit Jr. 4-Pin power connector.
3. Plug the AC cable into the Power Supply and into the wall socket.
DO NOT power up your system by plugging in live power.
4. To flash a module with the Boson, put the carrier in Force Recovery mode. Follow these steps:
 - a. Install the Orin™ NX or Nano module at P1
 - b. Connect Power at P13
 - c. Connect BOSON to a PC with a USB type-C cable at P6
 - d. Press SW2 (RESET) and SW3 (RECOVERY) at the same time
 - e. Release SW2 (RESET) first while continuing to hold down SW3 (RECOVERY)
 - f. Release SW3 (RECOVERY) after 1 to 2 seconds.
 - g. The board should now be in Force Recovery mode and should appear as NVIDIA® Corp. in the terminal of the PC and can now be flashed

POWER CONSUMPTION & THERMALS

Boson/ Boson 22 for Orin has an Operating Temperature Range of -25°C to +85°C. However, it is important to note that the NVIDIA® Jetson™ module has its own properties separate from that of the Boson/ Boson 22 for Orin Carrier Board, and care should be taken to not exceed module maximum component temperatures.

Customer responsibility requires proper implementation of a thermal solution that maintains the Boson/ Boson 22 for Orin carrier board and module temperatures below the specified temperatures (shown in the tables below) under the maximum thermal load and system conditions for their use case.

NVIDIA® Jetson™ Orin™ NX

Parameter	Value	Units
Maximum Orin™ NX SoC Operating Temperature	T.cpu = 90.5	°C
	T.gpu = 91.5	°C
	T.aux = 90.0	°C
Orin™ NX SoC Shutdown Temperature	T.cpu = 96.0	°C
	T.gpu = 97.0	°C
	T.aux = 95.5	°C

CURRENT CONSUMPTION DETAILS

Parameter	Value	Units	Value	Units	Temperature
Boson/ Boson 22 for Orin with NVIDIA® Jetson Orin NX™ module Installed, Fully-Booted, Idle, Passive Cooling	12	V	6.1	W	25°C (typ.)
Boson/ Boson 22 for Orin with NVIDIA® Jetson Orin NX™ module Installed, Fully-Booted, Idle, Passive Cooling and external cooling fan, 4 Cameras streaming and displaying	12	V	13.8	W	25°C (typ.)

SOFTWARE / BSP DETAILS

All of Connect Tech’s NVIDIA® Jetson™ based products are built upon a modified Linux for Tegra (L4T) Device Tree that is specific to each unique product.

WARNING: The hardware configurations of Connect Tech’s products differ from those of the NVIDIA® supplied evaluation kit. Please review the product documentation and install ONLY the appropriate Connect Tech L4T BSPs. Failure to follow this process could result in non-functional hardware.

CABLES (NOT INCLUDED)

Description	Part Number	Qty
Power Input Cable	CBG408	1
Misc. I/O Cable	CBG125	1
Camera I/O Cable	CBG509	4 (For NGX020)
		1 (For NGX021)

ACCESSORIES

Description	Part Number
AC/DC Power Supply	MSG085

RECOMMENDED CAMERAS

Please refer to the [Boson/ Boson 22 for Orin recommended cameras](#) for a full list of supported cameras.