

Our Products Make Your Product Better®

To learn more about EMAC's products and services and how they can help your project

http://ftp.emacinc.com/Tech_Info/About_EMAC_Products_and_Services.pdf



Authorized Distributor, Integrator, and Value-Added Reseller

Manual downloaded from <ftp.emacinc.com>

For purchase information please contact info@emacinc.com

For technical support please submit a ticket at www.emacinc.com/support



User Manual

MIO-5152

**Intel® Atom™ x6000E series and
Intel® Celeron® N and J series 3.5"
SBC**

ADVANTECH

Enabling an Intelligent Planet

Copyright

The documentation and the software included with this product are copyrighted 2021 by Advantech Co., Ltd. All rights are reserved. Advantech Co., Ltd. reserves the right to make improvements in the products described in this manual at any time without notice. No part of this manual may be reproduced, copied, translated, or transmitted in any form or by any means without the prior written permission of Advantech Co., Ltd. The information provided in this manual is intended to be accurate and reliable. However, Advantech Co., Ltd. assumes no responsibility for its use, nor for any infringements of the rights of third parties that may result from its use.

Acknowledgments

Intel® is a trademark of Intel® Corporation.

AMI is a trademark of American Megatrends, Inc.

IBM, PC, PS/2, and VGA are trademarks of International Business Machines Corporation.

Microsoft Windows®, DirectX® is a registered trademark of Microsoft Corp.

All other product names or trademarks are properties of their respective owners.

For more information on this and other Advantech products, please visit our websites at:

<http://www.advantech.com>

<http://www.advantech.com/eplatform>

For technical support and service, please visit our support website at:

<http://support.advantech.com/>

This manual is for the MIO-5152.

Product Warranty (2 years)

Advantech warrants the original purchaser that each of its products will be free from defects in materials and workmanship for two years from the date of purchase.

This warranty does not apply to any products that have been repaired or altered by persons other than repair personnel authorized by Advantech, or products that have been subject to misuse, abuse, accident, or improper installation. Advantech assumes no liability under the terms of this warranty as a consequence of such events.

Because of Advantech's high quality-control standards and rigorous testing, most customers never need to use our repair service. If an Advantech product is defective, it will be repaired or replaced free of charge during the warranty period. For out-of-warranty repairs, customers will be billed according to the cost of replacement materials, service time, and freight. Please consult your dealer for more details.

If you believe your product to be defective, follow the steps outlined below.

1. Collect all the information about the problem encountered. (For example, CPU speed, Advantech products used, other hardware and software used, etc.) Note anything abnormal and list any onscreen messages displayed when the problem occurs.
2. Call your dealer and describe the problem. Please have your manual, product, and any helpful information readily available.
3. If your product is diagnosed as defective, obtain a return merchandise authorization (RMA) number from your dealer. This allows us to process your return more quickly.
4. Carefully pack the defective product, a completed Repair and Replacement Order Card, and a proof of purchase date (such as a photocopy of your sales receipt) into a shippable container. Products returned without a proof of purchase date are not eligible for warranty service.
5. Write the RMA number clearly on the outside of the package and ship the package prepaid to your dealer.

Declaration of Conformity

CE

This product has passed the CE test for environmental specifications when shielded cables are used for external wiring. We recommend the use of shielded cables. This type of cable is available from Advantech. Please contact your local supplier for ordering information.

Test conditions for passing also include the equipment being operated within an industrial enclosure. In order to protect the product from damage caused by electrostatic discharge (ESD) and EMI leakage, we strongly recommend the use of CE-compliant industrial enclosure products.

FCC Class B

This equipment has been tested and found to comply with the limits for a Class B digital device, pursuant to part 15 of the FCC Rules. These limits are designed to provide reasonable protection against harmful interference in a residential installation. This equipment generates, uses, and can radiate radio frequency energy and, if not installed and used in accordance with the instruction manual, may cause harmful interference to radio communications. However, there is no guarantee that interference will not occur in a particular installation. If this equipment does cause harmful interference to radio or television reception, which can be determined by turning the equipment off and on, the user is encouraged to try to correct the interference by one or more of the following measures:

- Reorient or relocate the receiving antenna.
- Increase the separation between the equipment and receiver.
- Connect the equipment into an outlet on a circuit different from that to which the receiver is connected.
- Consult the dealer or an experienced radio/TV technician for assistance.

Caution! *There is a danger of a new battery exploding if it is incorrectly installed. Do not attempt to recharge, force open, or heat the battery. Replace the battery only with the same or equivalent type recommended by the manual. Discard used batteries according to the manufacturer's instructions.*



Technical Support and Assistance

1. Visit the Advantech website at www.advantech.com/support to obtain the latest product information.
2. Contact your distributor, sales representative, or Advantech's customer service center for technical support if you need additional assistance. Please have the following information ready before calling:
 - Product name and serial number
 - Description of your peripheral attachments
 - Description of your software (operating system, version, application software, etc.)
 - A complete description of the problem
 - The exact wording of any error messages

Packing List

Before you begin installing your card, please make sure that the following materials have been shipped:

- 1 x MIO-5152 SBC
- 1 x SATA cable 30 cm (11.8 in) (p/n: 1700006291)
- 1 x SATA power cable 35 cm (13.77 in) (p/n: 1700031583-01)
- 1 x USB 2.0 cable 20 cm (7.87 in) (p/n: 1700030406-01)
- 1 x Audio cable 20 cm (7.87 in) (p/n: 1700019584-01)
- 6 x COM RS-232/422/485 cable 20 cm (7.87 in) (p/n: 1700030404-01)
- 1 x Heatsink for x6000E (p/n: 1970005053T001)
- 1 x Heatsink for Celeron series (p/n: 1970005053T011)
- 1 x Startup manual (p/n: 2046515200)
- 1 x DeviceOn package

If any of these items are missing or damaged, contact your distributor or sales representative immediately.

Contents

Chapter 1	General Information	1
1.1	Introduction	2
1.2	Specifications	2
1.3	Block Diagram.....	4
Chapter 2	Mechanical	5
2.1	Introduction	6
2.2	Board Layout: Dimensions	6
	Figure 2.1 MIO-5152 Mechanical Diagram (Top Side)	6
	Figure 2.2 MIO-5152 Mechanical Diagram (Bottom Side).....	6
	Figure 2.3 MIO-5152 Mechanical Diagram (Coastline)	7
	Figure 2.4 MIO-5152 Mechanical Diagram with Heatsink (Top Side)	7
	Figure 2.5 MIO-5152 Mechanical Diagram with Heatsink (Bottom Side)	8
	Figure 2.6 MIO-5152 Mechanical Diagram with Heatsink (Coastline).....	8
2.3	Quick Installation Guide	9
2.3.1	Heatsink	9
Chapter 3	Installation.....	11
3.1	Jumpers & Switches.....	12
	Table 3.1: Jumpers and Switches	12
3.2	Connectors.....	12
	Table 3.2: Connectors	12
3.3	Locating Connectors	13
	Figure 3.1 MIO-5152 Connector Locations (Top Side).....	13
	Figure 3.2 MIO-5152 Connector Locations (Bottom Side).....	13
3.4	Setting Jumpers	14
3.4.1	CMOS Clear Switch (JCMOS1).....	14
3.4.2	Panel Voltage Selection (VDD1).....	15
3.4.3	COM RI# pin 5V/12V Selection (RI_VDD1).....	15
3.4.4	ATX/AT Mode Selection.....	16
3.4.5	DC Input Connector	16
3.4.6	DC Input Connector (Adapter)	17
3.4.7	Internal USB Connector	17
3.4.8	COM Port Connector (RS232+RS422+RS485).....	18
3.4.9	COM port Connector (RS232+RS422+RS485)	19
3.4.10	COM Port Connector (RS232).....	20
3.4.11	COM Port Connector (RS232).....	21
3.4.12	COM Port Connector (RS232).....	22
3.4.13	COM Port Connector (RS232).....	23
3.4.14	Audio Connector	24
3.4.15	LVDS Connector	24
3.4.16	SMB Connector.....	26
3.4.17	FAN Connector	26
3.4.18	HDD Power Connector	27
3.4.19	Panel Inverter Connector	27
3.4.20	GPIO Connector	28
3.4.21	Power/LED/Case Open/Buzzer Connector.....	29
3.4.22	Key B Connector.....	30

3.4.23	Key E Connector.....	32
3.4.24	Key M Connector	34
3.4.25	RTC Battery Connector	36

Chapter 4 AMI BIOS Setup..... 37

4.1	Entering Setup	39
4.1.1	Main Setup.....	39
4.1.2	Advanced BIOS Features Setup.....	40
4.1.3	Chipset Configuration	64
4.1.4	Security.....	76
4.1.5	Boot	77
4.1.6	Save & Exit	78

Appendix A System Assignments..... 79

A.1	System I/O Ports.....	80
	Table A.1: System I/O Ports	80
A.2	DMA Channel Assignments	81
	Table A.2: DMA Channel Assignments	81
A.3	1st MB Memory Map.....	81
	Table A.3: 1st MB Memory Map	81
A.4	Interrupt Assignments	81
	Table A.4: Interrupt Assignments	81

Chapter 1

General Information

This chapter details background information on the MIO-5152.

Sections include:

- Introduction
- Specifications
- Block diagram

1.1 Introduction

Advantech MIO-5152 is a 3.5" form factor SBC (compact series, 146 x 102 mm; 5.7 x 4.01 in). Powered by Intel® Atom® x6000E series and Intel® Celeron® N and J series processors, it provides embedded iManager 3.0, SUSI 4.0, and Advantech's WISE-DeviceOn to monitor and control system operation effectively and remotely. MIO-5152 supports single channel DDR4-3200 up to 32GB, 3 x independent displays via LVDS, DP1.4, HDMI 1.4 up to 4K@30Hz, Dual GbE, 6 x USB, 6 x UART, and TPM2.0.

1.2 Specifications

Platform	Processor	Celeron J6412	Celeron N6210	Atom® x6425E
	Max. Frequency	2.60 GHz	2.60 GHz	3.00 GHz
	Base Frequency	2.00 GHz	1.20 GHz	2.00 GHz
	Core/Tread	4/4	2/2	4/4
	LLC	L2	L2	L2
	CPU TDP	10W	6.5W	12W
	Chipset	Intel Series Chipset (SoC Integrated)		
	BIOS	AMI EFI 256Mbit		
Memory	Technology	DDR4-3200		
	Max. Capacity	32GB		
	Channel/Socket	Single Channel / 1x Socket		
	ECC Support	No	No	Yes
Graphics	Controller	Intel Gen11 Graphics Engines (SoC integrated)		
	Max. Frequency	800MHz	750MHz	750MHz
	Graphics Memory	400MHz	250MHz	500MHz
	3D/HW Acceleration	DX12, OGL4.5, OCL1.2, Vulkan 1.1, MPEG2, H.264, JPEG/MJPEG, H.265 (HEVC)		
Display I/F	LCD	1 x LVDS: Dual Channel 18/24-bit, up to 1920 x 1200		
	HDMI/DP	1 x HDMI 1.4, up to 4096 x 2160 x 24bpp@30Hz 1 x DP1.4a, up to 4096 x 2160 x 36bpp@60Hz		
	Multiple Display	3 x simultaneous displays with LVDS, HDMI, DP		
Ethernet	Controller	LAN1: Realtek RTL8111H, LAN2: Realtek RTL8111H		
	Speed	10/100/1000 Mbps		
External I/O	Ethernet	2 x RJ-45		
	HDMI/DP	1/1		
	USB 3.2	4 x TypeA; 4 x USB 3.2 Gen2 (10Gbps)		
	Power DC-Jack	Optional		

Internal I/O	SATA	1 x SATA GenIII 6.0Gbps
	USB 2.0	2 x
	Serial Bus	I2C (support 400Kbit/s)
	COM Port	2 x RS-232/422/485 (support 1Mbps), 4 x RS-232 (115.2kbps)
	GPIO	8-bit general purpose input output I/O
	Audio	Realtek ALC888s, Line-in/Line-out/MIC
	Inverter	12V/5V
	SPI Bus	eSPI
	Fan	4-wire smart fan
	Front Panel Control	Power-on, Reset, Buzzer, SATA LED, CaseOpen
Board Feature	Watchdog Timer	Programmable 1 ~ 255 sec/min
	TPM	TPM2.0, NPCT750AABYX
	iManager 3.0	SW API for Hardware Monitor, Smart Fan Control, Brightness Control, I2C, GPIO, WDT
Expansion	M.2 E-Key/ B-Key	1 x E-Key 2230 (PCIe x1, USB 2.0) Optional 1 x B-Key 3042 (PCIe, USB 2.0) w/ Nano-SIM
	M.2 M-Key	1 x M-Key 2242 (SATA x1)
Power	Supply Voltage	Vin: DC 12V +/- 10%; RTC Battery: Lithium 3V/210mAH
	Connector	ATX 2x2pin 90D, optional DC-Jack
	Power Management	AT, ATX
	Max. Consumption	21.39 W
	Idle Consumption	7.31 W
Environment	Temperature	Operating: Standard: 0 ~ 60 °C (32 ~ 140 °F)
	Humidity	Operating: 40 °C(104 °F) @ 95% relative humidity, non-condensing
	Vibration Resistance	3.5 Grms
Software	OS	Windows10, Linux 20.04
	Software & API	WISE-DeviceOn and iManager 3.0
Certification	EMC	CE, FCC Class B
Mechanical	Dimensions	146 x 102 mm (5.7 x 4 in)

Note! Support by request



1.3 Block Diagram

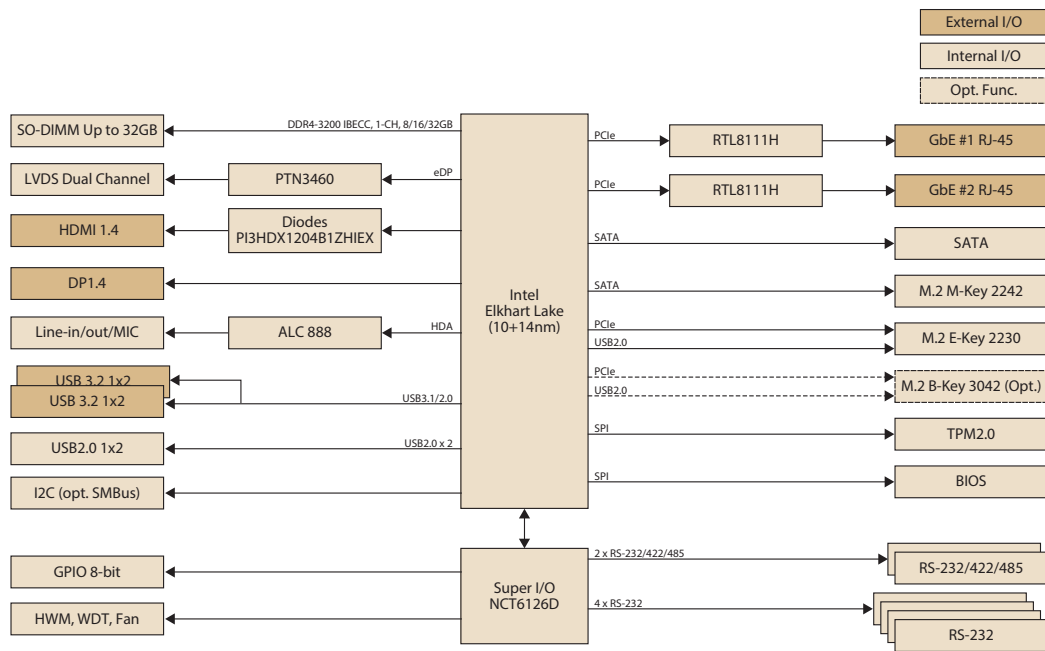

Chapter 2

Mechanical

This chapter details mechanical information on the MIO-5152.

Sections include:

- Mechanical Diagrams
- Assembly Diagrams

2.1 Introduction

The MIO compact form factor SBC is a new-generation SBC designed- with a variety of mechanical improvements. Here is the quick installation guide for the thermal design and MIOe module. This chapter includes board dimension and assembly instructions for the standard thermal solution.

2.2 Board Layout: Dimensions

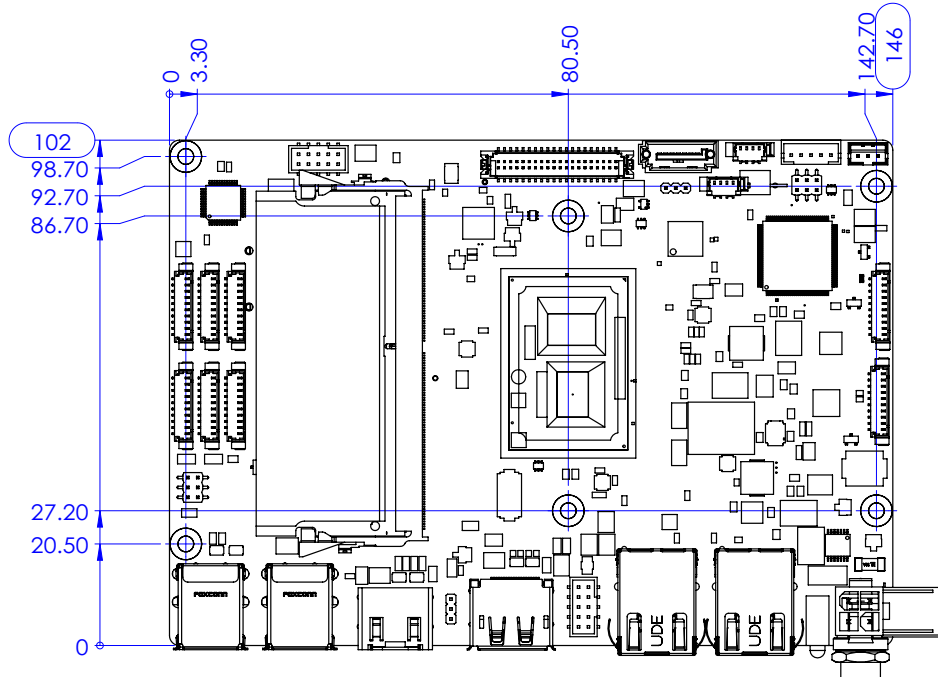

Figure 2.1 MIO-5152 Mechanical Diagram (Top Side)

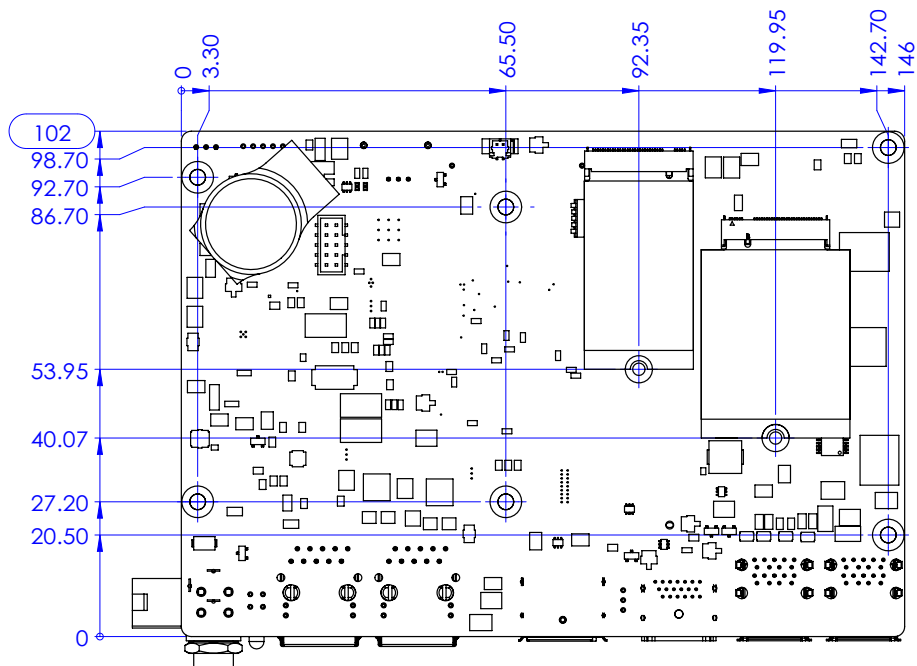

Figure 2.2 MIO-5152 Mechanical Diagram (Bottom Side)

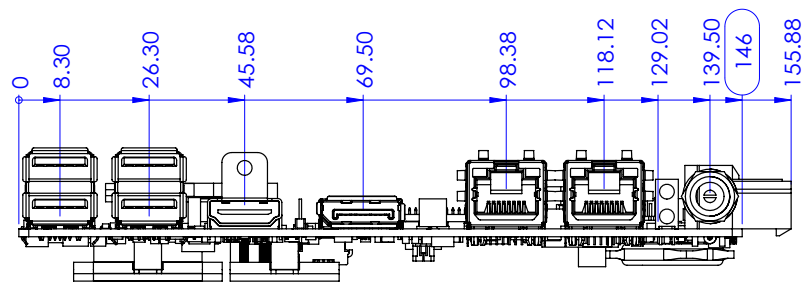

Figure 2.3 MIO-5152 Mechanical Diagram (Coastline)

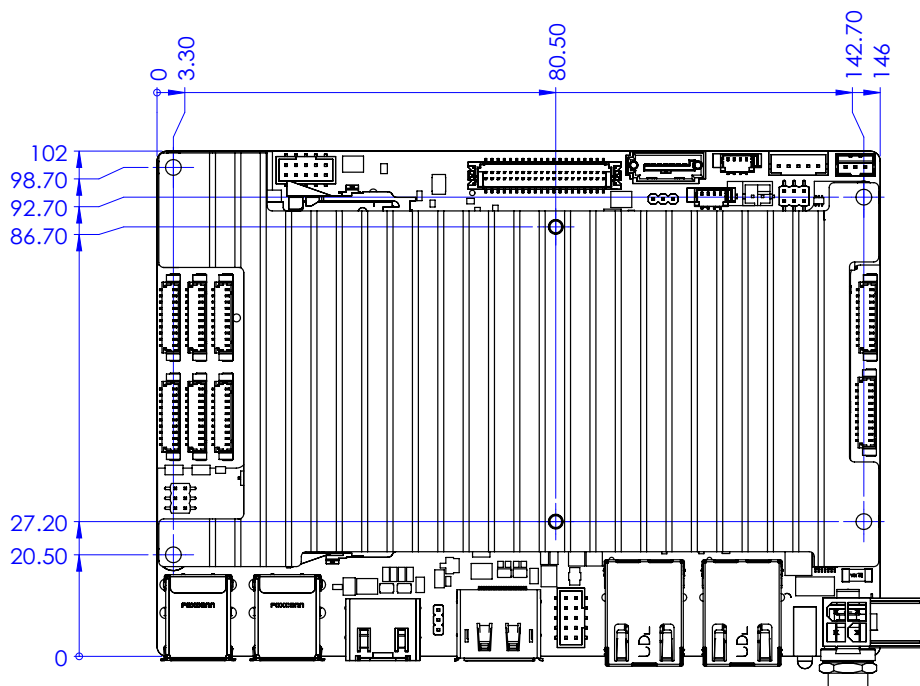

Figure 2.4 MIO-5152 Mechanical Diagram with Heatsink (Top Side)

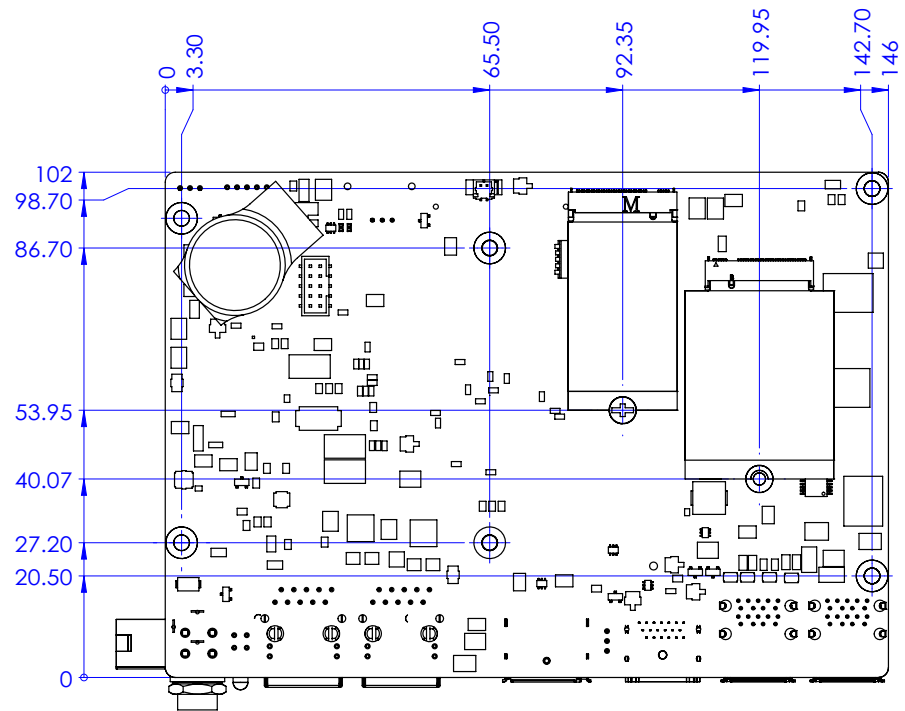

Figure 2.5 MIO-5152 Mechanical Diagram with Heatsink (Bottom Side)

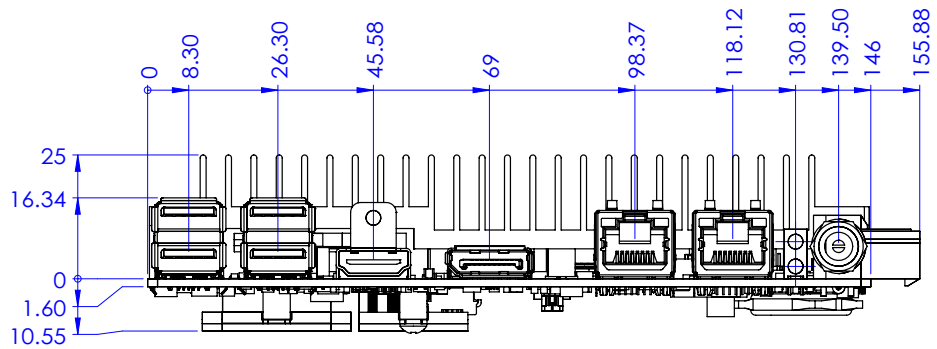
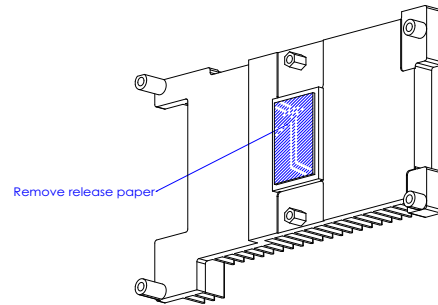
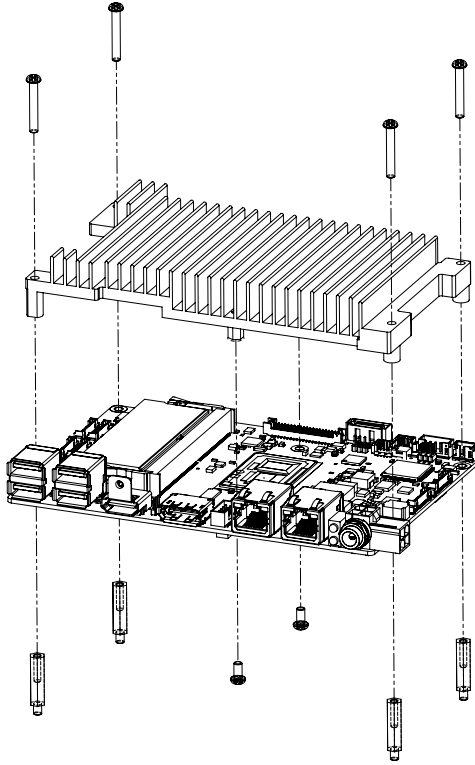

Figure 2.6 MIO-5152 Mechanical Diagram with Heatsink (Coastline)

2.3 Quick Installation Guide

There is a Heatsink in the white box inside the package. Please assemble it by following the diagrams below. Remember to remove the plastic on the thermal pad before you assemble the mechanical parts.

2.3.1 Heatsink



Chapter 3

Installation

This chapter explains the setup procedures of the MIO-5152 hardware — including instructions on setting jumpers and connecting peripherals, switches, and indicators. Be sure to read all safety precautions before you begin the installation procedure.

3.1 Jumpers & Switches

The MIO-5152 has a number of jumpers that allow you to configure your system to suit your application. The table below lists the functions of the various jumpers.

Table 3.1: Jumpers and Switches

JCMOS1	CMOS Clear Switch
VDD1	Panel Voltage Selection
RI_VDD1	COM RI# pin 5V/12V Selection
PSON1	ATX/AT Mode Selection

3.2 Connectors

Onboard connectors link the MIO-5152 to external devices such as hard disk drives and keyboards. The table below lists the function of each of the board's connectors.

Table 3.2: Connectors

	Description	Location Name
1	DC input Connector	DCIN1
2	DC input Connector (Adapter)	DCIN1
3	Internal USB Connector	USB56
4	COM port Connector (RS232+RS422+RS485)	COM1
5	COM port Connector (RS232+RS422+RS485)	COM2
6	COM port Connector (RS232 only)	COM3
7	COM port Connector (RS232 only)	COM4
8	COM port Connector (RS232 only)	COM5
9	COM port Connector (RS232 only)	COM6
10	Audio Connector	AUDIO1
11	LVDS Connector	LVDS1
12	SMB Bus Connector	SMB1
13	FAN connector	FAN1
14	HDD Power Connector	SATAP1
15	Inverter Connector	BL1
16	GPIO Connector	GPIO1
17	Power/LED/Case Open/Buzzer Connector	CN2
18	M.2 Key B (PCIe_USB2.0)	M2_B1
19	M.2 Key E (PCIe_USB2.0)	M2E1_1
20	M.2 Key M (SATA)	M2_M1
21	RTC Battery Connector	BAT1

3.3 Locating Connectors

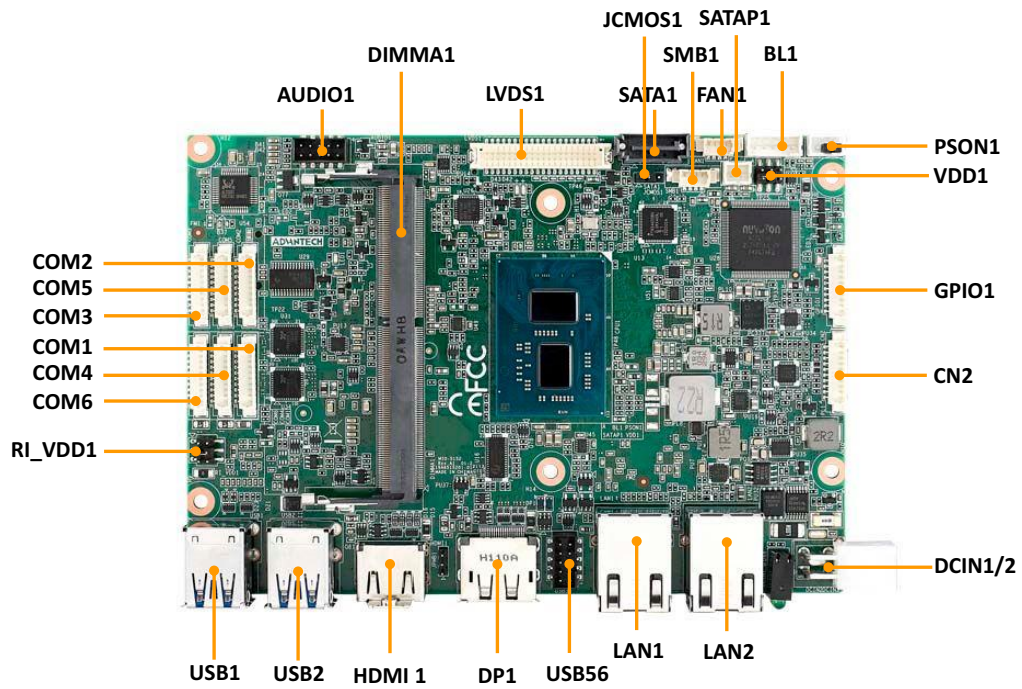

Figure 3.1 MIO-512 Connector Locations (Top Side)

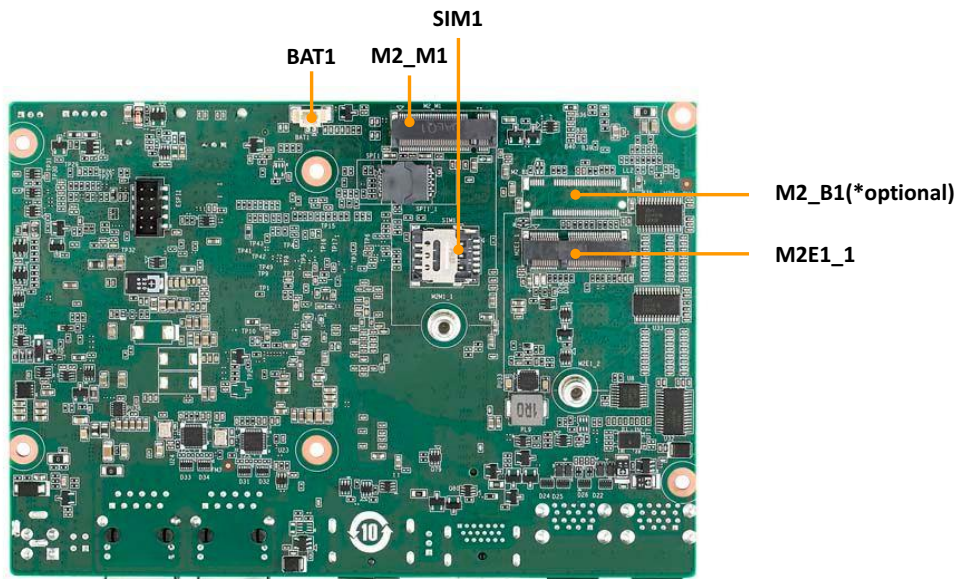
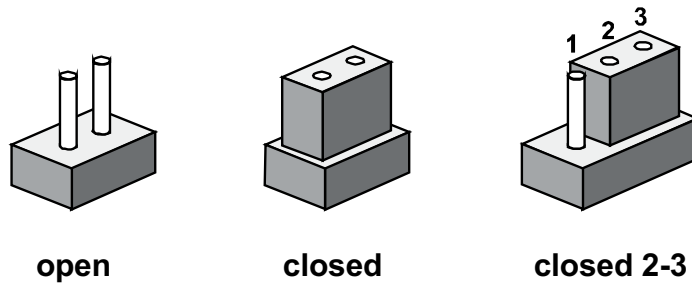

Figure 3.2 MIO-512 Connector Locations (Bottom Side)

3.4 Setting Jumpers

You may configure your card to match the needs of your application by setting jumpers. A jumper is a metal bridge used to close an electric circuit. It consists of two metal pins and a small metal clip (often protected by a plastic cover) that slides over the pins to connect them. To “close” a jumper, you connect the pins with the clip. To “open” a jumper, you remove the clip. Sometimes a jumper will have three pins, labeled 1, 2, and 3. In this case you would connect either pins 1 and 2, or 2 and 3.

The jumper settings are schematically depicted in this manual as follows:





A pair of needle-nosed pliers may be helpful when working with jumpers. If you have any doubts about the best hardware configuration for your application, contact your local distributor or sales representative before you make any changes. Generally, you simply need a standard cable to make most connections.

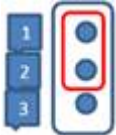
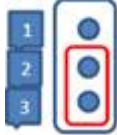

3.4.1 CMOS Clear Switch (JCMOS1)

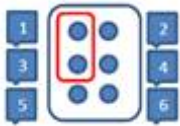
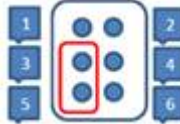
Function	Jumper Setting
Keep COMS Data (Default)	
Load CMOS Date	
Pin	Signal Pin Definition
1	NC
2	FAILSAFE_BIOS
3	GND

3.4.2 Panel Voltage Selection (VDD1)

Function	Jumper Setting
Panel Voltage Setting: +V3.3 (Default)	
Panel Voltage Setting: +V5	
Panel Voltage Setting: +V12	
Pin	Signal Pin Definition
1	+V3.3
2	NC
3	+V_LVDS_LCD
4	+V12
5	+V5
6	NC

3.4.3 COM RI# pin 5V/12V Selection (RI_VDD1)

Function	Jumper Setting
RI# Voltage Setting: +V5	
RI# Voltage Setting: +V12	
RI# Voltage Setting: RI# (Default)	

Pin	Signal Pin Definition
1	+V5
2	COM1_z_RI#
3	COM_RI#
4	COM1_z_RI#
5	+V12
6	COM1_z_RI#

3.4.4 ATX/AT Mode Selection

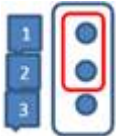
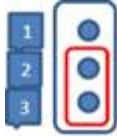
Function	Jumper Setting
BIOS setting to AT mode	
BIOS setting to ATX mode	

3.4.5 DC Input Connector

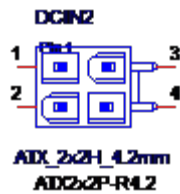

Pin	Signal Pin Definition
1	GND
2	GND
3	+V12_DC_IN
4	+V12_DC_IN

3.4.6 DC Input Connector (Adapter)



Pin	Signal Pin Definition
1	+V12_DC_IN
2	NC
3	GND

3.4.7 Internal USB Connector

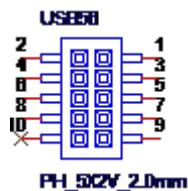

Pin	Signal Pin Definition
1	+USBV3
2	+USBV3
3	USB2_D6-
4	USB2_D5-
5	USB2_D6+
6	USB2_D5+
7	GND
8	GND
9	N24172033
10	NC

3.4.8 COM Port Connector (RS232+RS422+RS485)

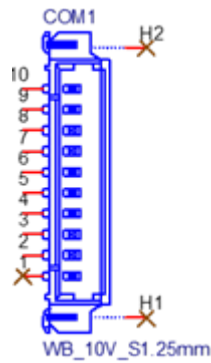
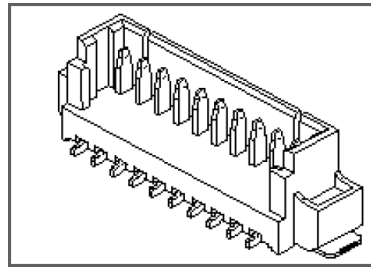

Pin	Signal Pin Definition
1	NC
2	COM1_Z_RI#
3	COM1_DTR#
4	COM1_CTS#
5	COM1_TXD
6	COM1_RTS#
7	COM1_RXD
8	COM1_DSR#
9	COM1_DCD#
10	GND

3.4.9 COM port Connector (RS232+RS422+RS485)

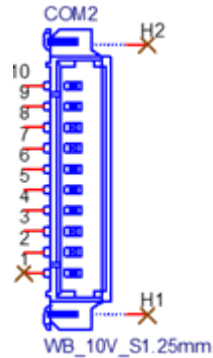
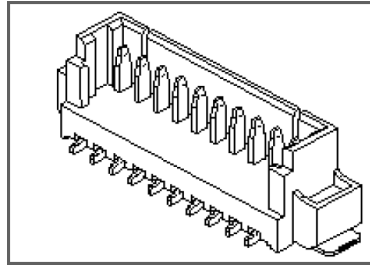

Pin	Signal Pin Definition
1	
2	COM2_RI#
3	COM2_DTR#
4	COM2_CTS#
5	COM2_TXD
6	COM2_RTS#
7	COM2_RXD
8	COM2_DSR#
9	COM2_DCD#
10	GND

3.4.10 COM Port Connector (RS232)

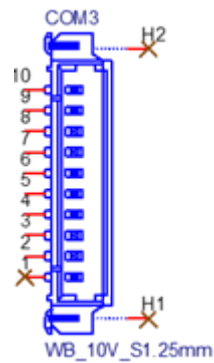
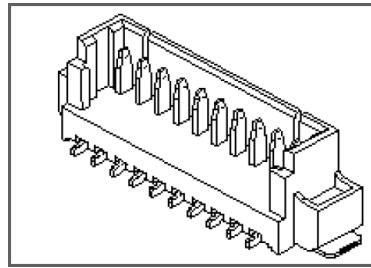

Pin	Signal Pin Definition
1	NC
2	COM3_RI#
3	COM3_DTR#
4	COM3_CTS#
5	COM3_SOUT
6	COM3_RTS#
7	COM3_SIN
8	COM3_DSR#
9	COM3_DCD#
10	GND

3.4.11 COM Port Connector (RS232)

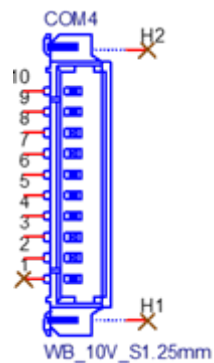
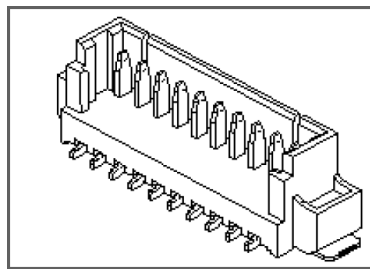

Pin	Signal Pin Definition
1	NC
2	COM4_RI#
3	COM4_DTR#
4	COM4_CTS#
5	COM4_SOUT
6	COM4_RTS#
7	COM4_SIN
8	COM4_DSR#
9	COM4_DCD#
10	GND

3.4.12 COM Port Connector (RS232)

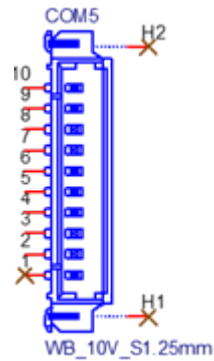
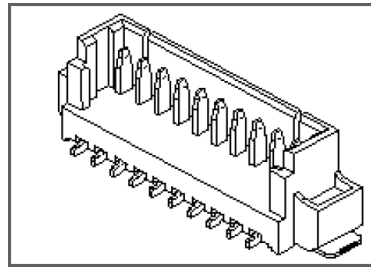

Pin	Signal Pin Definition
1	NC
2	COM5_RI#
3	COM5_DTR#
4	COM5_CTS#
5	COM5_SOUT
6	COM5_RTS#
7	COM5_SIN
8	COM5_DSR#
9	COM5_DCD#
10	GND

3.4.13 COM Port Connector (RS232)

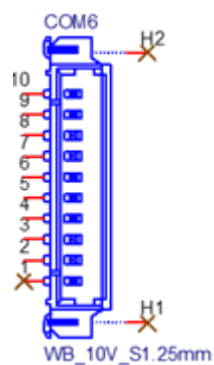
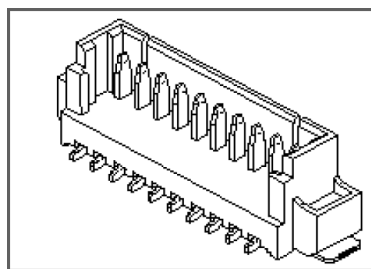

Pin	Signal Pin Definition
1	NC
2	COM6_RI#
3	COM6_DTR#
4	COM6_CTS#
5	COM6_SOUT
6	COM6_RTS#
7	COM6_SIN
8	COM6_DSR#
9	COM6_DCD#
10	GND

3.4.14 Audio Connector

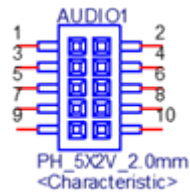

Pin	Signal Pin Definition
1	LOU+R
2	LIN+R
3	GND
4	GND
5	LOU+L
6	LIN+L
7	GND
8	NC
9	MIC1R
10	MIC1L

3.4.15 LVDS Connector

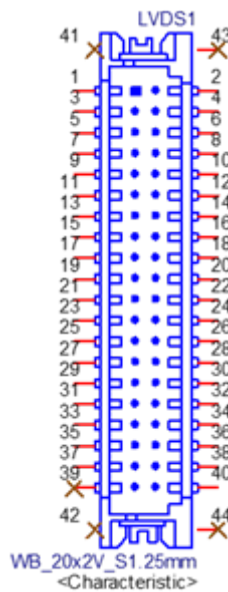

Pin	Signal Pin Definition
1	+V_LCD
2	+V_LCD
3	GND
4	GND
5	+V_LCD
6	+V_LCD

7	LVDS1_0_D0-
8	LVDS1_1_D0-
9	LVDS1_0_D0+
10	LVDS1_1_D0+
11	GND
12	GND
13	LVDS1_0_D1-
14	LVDS1_1_D1-
15	LVDS1_0_D1+
16	LVDS1_1_D1+
17	GND
18	GND
19	LVDS1_0_D2-
20	LVDS1_1_D2-
21	LVDS1_0_D2+
22	LVDS1_1_D2+
23	GND
24	GND
25	LVDS1_0_CLK-
26	LVDS1_1_CLK-
27	LVDS1_0_CLK+
28	LVDS1_1_CLK+
29	GND
30	GND
31	NC
32	NC
33	GND
34	GND
35	LVDS1_0_D3-
36	LVDS1_1_D3-
37	LVDS1_0_D3+
38	LVDS1_1_D3+
39	NC
40	LVDS1_VCON

3.4.16 SMB Connector

■ **Install the I2C driver manually**

1. Go from Device Manager to System device. Then go to Intel® Serial IO I2C Controller #2 — 4B7A. Right click to update driver from the specified I2C driver folder.

■ **How to enable I2C**

1. Go to Device Manager then to System device. Next go to Intel Serial IO I2C Host Controller — 4B7A. Enter Power Management then Disable “Allow the computer to turn off”
2. Disable the SUSI4 driver, then enable the SUSI4 driver

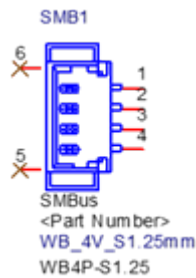

Pin	Signal Pin Definition
1	GND
2	EC_SMB0_z_DAT
3	EC_SMB0_z_CLK
4	+V3.3_DUAL

3.4.17 FAN Connector

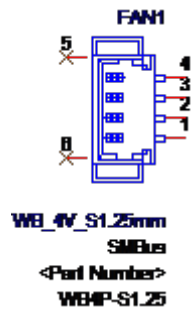

Pin	Signal Pin Definition
1	GND
2	+V12
3	FAN_SPEED
4	FAN_V5_PWM

3.4.18 HDD Power Connector



Pin	Signal Pin Definition
1	5V
2	GND

3.4.19 Panel Inverter Connector

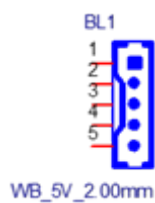

Pin	Signal Pin Definition
1	+V12_1_INVERTER_0
2	GND
3	LVDS1_Z_ENABKL
4	EC_LVDS1_Z_PWM
5	+V5_1_INVERTER_0

3.4.20 GPIO Connector

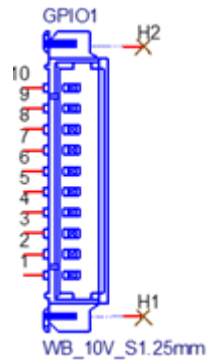
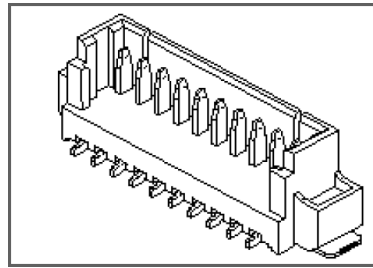

Pin	Signal Pin Definition
1	GND
2	SIO_GPIO7
3	SIO_GPIO2
4	SIO_GPIO6
5	SIO_GPIO1
6	SIO_GPIO5
7	SIO_GPIO0
8	SIO_GPIO4
9	+V5A_GPIO
10	SIO_GPIO3

3.4.21 Power/LED/Case Open/Buzzer Connector

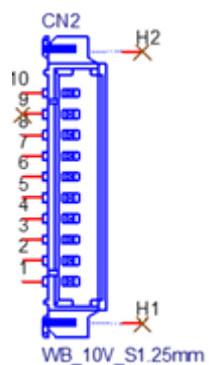
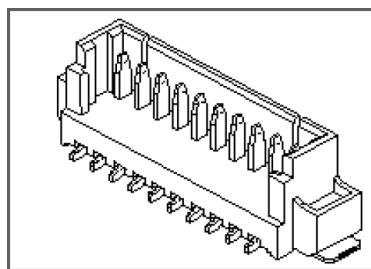

Pin	Signal Pin Definition
1	GND
2	BUZZER-
3	BUZZER+
4	RDC_CASEOPEN
5	SATA_EXT_LED#
6	FP_A_PSIN#
7	FP_A_RST#
8	+3.3V
9	NC
10	+5V

3.4.22 Key B Connector



Pin	Signal Pin Definition
1	+V3.3_DUAL
2	+V3.3_DUAL
3	GND
4	+V3.3_DUAL
5	GND
6	M2B1_POWER_OFF#_R
7	USB2_M2B1_P4+
8	M2B1_W_DISABLE#_R
9	USB2_M2B1_P4-
10	M2B1_LED1#
11	GND
12	M2B1_I2S_SCLK
13	+V3.3_DUAL
14	M2B1_I2S_TXD
15	M2B1_WAKE_WWAN#
16	M2B1_R_I2S_RXD
17	M2B1_SAR_DPR_WWAN
18	M2B1_GNSS_DISABLE#_R

19	GND
20	M2B1_I2S_SFRM_R
21	NC
22	UIM_RESET
23	NC
24	UIM_CLK
25	GND
26	UIM_DATA
27	NC
28	UIM_PWR
29	NC
30	M2B1_SATA_DEVSLP_R
31	GND
32	NC
33	PCIE5_RX-
34	NC
35	PCIE5_RX+
36	NC
37	GND
38	NC
39	M2PCIE_M2SATA_TX-
40	NC
41	M2PCIE_M2SATA_TX+
42	M2B1_PLTRST#
43	GND
44	M2B1_CLKREQ2#_R
45	M2B1_CLK-
46	M2B1_PCIE_WAKE#
47	M2B1_CLK+
48	NC
49	GND
50	NC
51	NC
52	NC
53	NC
54	NC
55	NC
56	NC
57	NC
58	NC
59	M2B1_RESET#_R
60	M2B1_SUSCLK
61	+V3.3_DUAL
62	+V3.3_DUAL
63	GND
64	+V3.3_DUAL
65	GND
66	+V3.3_DUAL

67	+V3.3_DUAL
68	NC
69	NC
70	GND
71	GND

3.4.23 Key E Connector

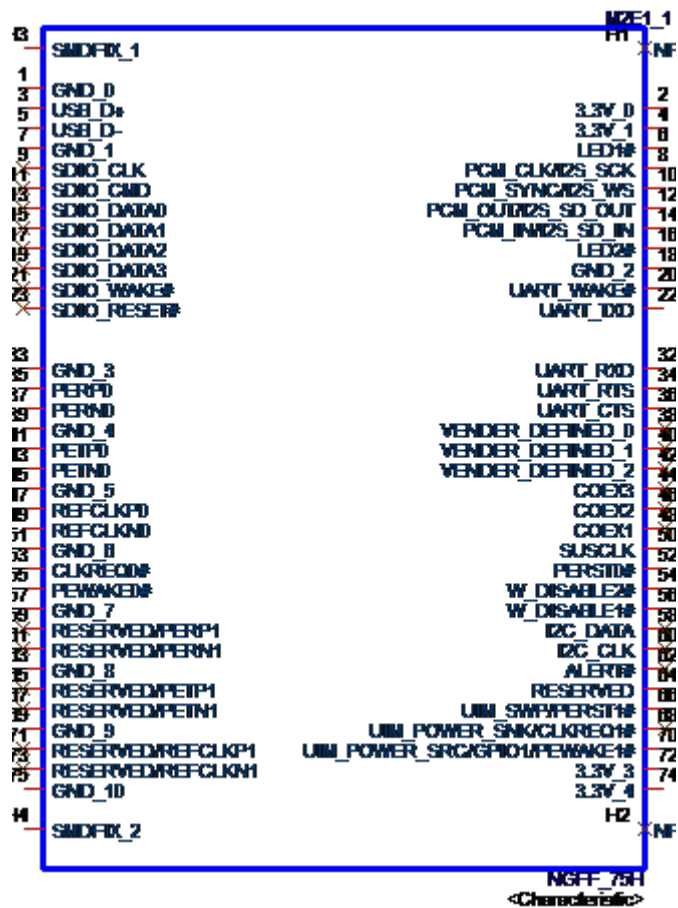

Pin	Signal Pin Definition
1	GND
2	+V3.3_M2E1
3	USB2_M2E1_P9+
4	+V3.3_M2E1
5	USB2_M2E1_P9-
6	M.2_WLAN_LED1#
7	GND
8	BT_I2S_SCLK
9	NC
10	BT_I2S_BCLK
11	NC
12	BT_I2S_SDO

13	NC
14	BT_I2S_SDI
15	NC
16	M.2_BT_LED2
17	NC
18	GND
19	NC
20	UART_BT_WAKE#_R
21	NC
22	M2E1_UART_RXD
23	NC
24	M2E1_UART_TXD
25	GND
26	M2E1_UART_CTS#
27	M2E1_PCIE_TX+
28	M2E1_UART_RTS#
29	M2E1_PCIE_TX-
30	NC
31	GND
32	NC
33	M2E1_PCIE_RX+
34	NC
35	M2E1_PCIE_RX-
36	NC
37	GND
38	NC
39	M2E1_CLK+
40	NC
41	M2E1_CLK-
42	M2E1_SUSCLK
43	GND
44	M2E1_PLTRST#
45	M2E1_Z_CLKREQ1#
46	M2E1_BT_DISABLE#_R
47	WLAN_PCIE_WAKE#
48	M2E1_WIFI_OFF#_R
49	GND
50	NC
51	NC
52	NC
53	NC
54	NC
55	GND
56	TP_M2E1_38P4M_REFCLK
57	NC
58	PLTRST_M.2#
59	NC
60	NC

61	GND
62	M2E1_PCIE_WAKE1#
63	NC
64	+V3.3_M2E1
65	NC
66	+V3.3_M2E1
67	GND
68	NC
69	NC
70	GND
71	GND

3.4.24 Key M Connector

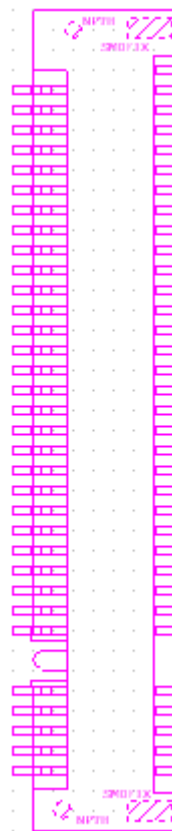

Pin	Signal Pin Definition
1	GND
2	+V3.3_M.2
3	GND
4	+V3.3_M.2
5	NC
6	NC
7	NC
8	NC
9	GND

10	M.2_LED#
11	NC
12	+V3.3_M.2
13	NC
14	+V3.3_M.2
15	GND
16	+V3.3_M.2
17	NC
18	+V3.3_M.2
19	NC
20	NC
21	GND
22	NC
23	NC
24	NC
25	NC
26	NC
27	GND
28	NC
29	NC
30	NC
31	NC
32	NC
33	GND
34	NC
35	NC
36	NC
37	NC
38	NC
39	GND
40	NC
41	MPCIE_MSATA_RX+
42	NC
43	MPCIE_MSATA_RX-
44	NC
45	GND
46	NC
47	MPCIE_MSATA_TX-
48	NC
49	MPCIE_MSATA_TX+
50	PLTRST_MKEY_BUFFER#
51	GND
52	NC
53	NC
54	M.2_PCIE_WAKE#
55	NC
56	NC
57	GND

58	NC
59	NC
60	NC
61	M2_SATA_2_1B_PEDET
62	+V3.3_M.2
63	GND
64	+V3.3_M.2
65	GND
66	+V3.3_M.2
67	GND
68	NC
69	NC
70	GND
71	GND

3.4.25 RTC Battery Connector

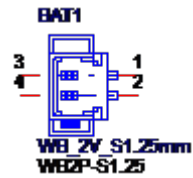

Pin	Signal Pin Definition (Key M)
1	+VBAT_R
2	GND

Chapter 4

AMI BIOS Setup

AMIBIOS has been integrated into many motherboards for over a decade. With the AMIBIOS Setup program, you can modify BIOS settings and control the various system features. This chapter describes the basic navigation of the MIO-5152 BIOS setup screens.

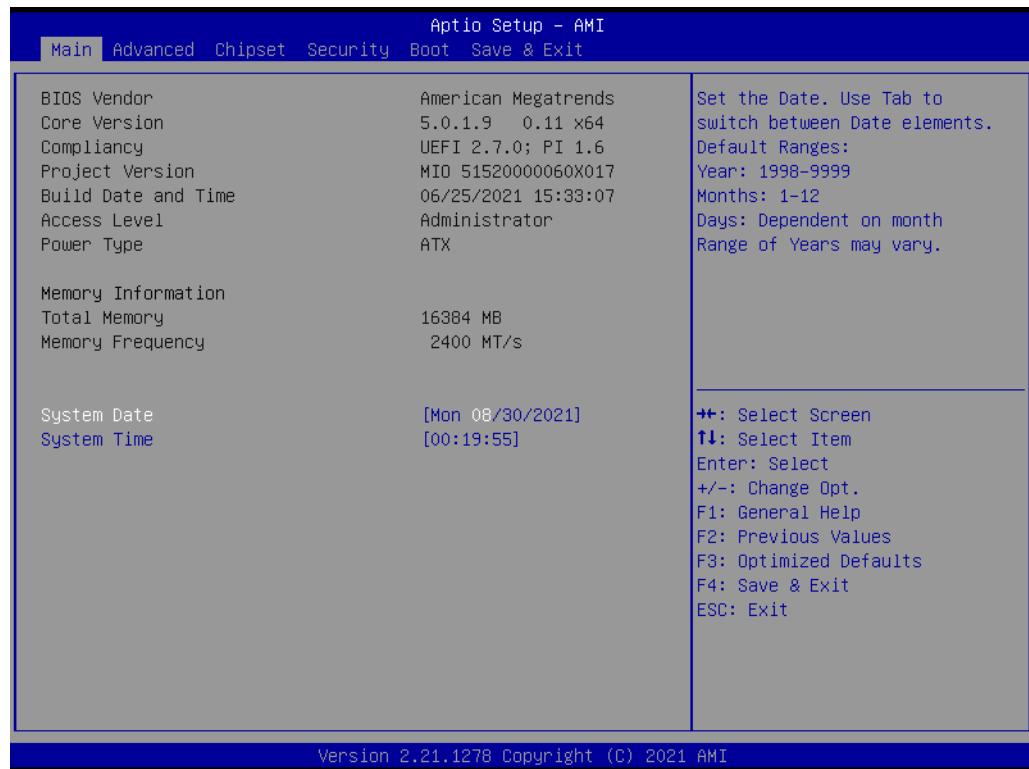

AMI's BIOS ROM has a built-in setup program that allows users to modify the basic system configuration. This information is stored in battery-backed CMOS so it retains the Setup information when the power is turned off.

4.1 Entering Setup

Turn on the computer and check for the patch code. If there is a number assigned to the patch code, it means that the BIOS supports your CPU. If there is no number assigned to the patch code, please contact an Advantech application engineer to obtain an up-to-date patch code file. This will ensure that your CPU's system status is valid. After ensuring that you have a number assigned to the patch code, press and you will immediately be allowed to enter Setup.

4.1.1 Main Setup

When you first enter the BIOS Setup Utility, you will encounter the Main setup screen. You can always return to the Main setup screen by selecting the Main tab. There are two Main Setup options. They are described in this section. The Main BIOS Setup screen is shown below.



The Main BIOS setup screen has two main frames. The left frame displays all the options that can be configured. Grayed-out options cannot be configured; options in blue can. The right frame displays the key legend.

Above the key legend is an area reserved for a text message. When an option is selected in the left frame, it is highlighted in white. Often a text message will accompany it.

■ System time / System date

Use this option to change the system time and date. Highlight System Time or System Date using the <Arrow> keys. Enter new values through the keyboard. Press the <Tab> key or the <Arrow> keys to move between fields. The date must be entered in MM/DD/YY format. The time must be entered in HH:MM:SS format.

4.1.2 Advanced BIOS Features Setup

Select the Advanced tab from the MIO-5152 setup screen to enter the Advanced BIOS Setup screen. You can select any of the items in the left frame of the screen, such as CPU Configuration, to go to the sub menu for that item. You can display an Advanced BIOS Setup option by highlighting it using the <Arrow> keys. All Advanced BIOS Setup options are described in this section. The Advanced BIOS Setup screens are shown below. The sub menus are described on the following pages.

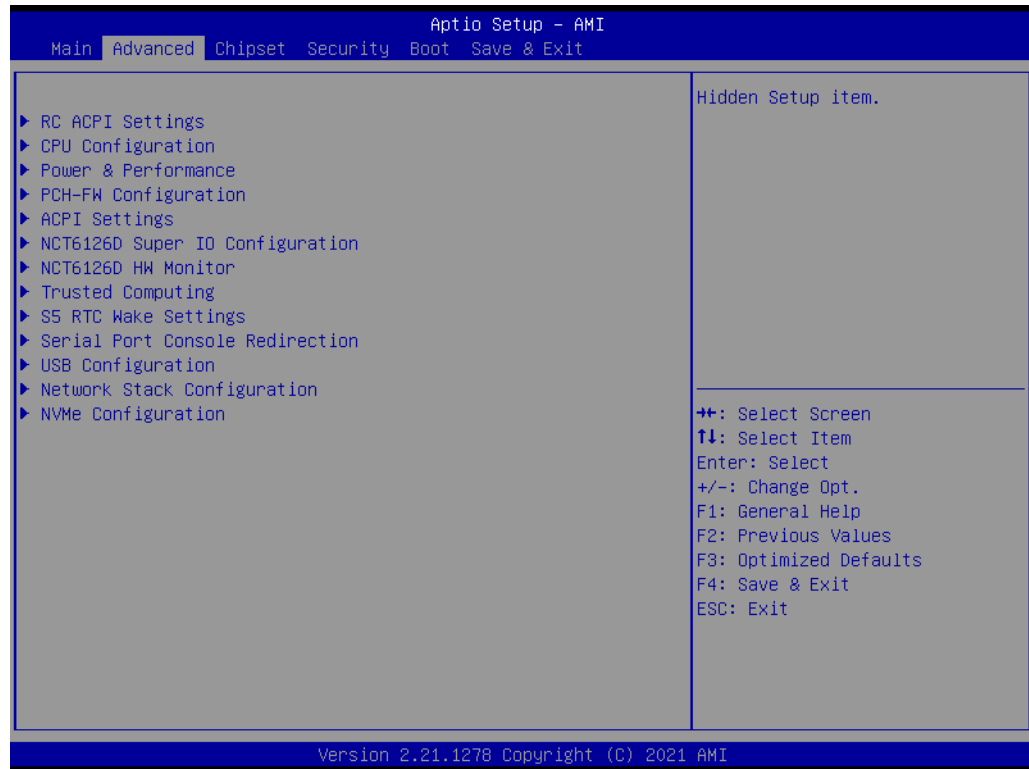

4.1.2.1 RC ACPI Settings



Native PCIE Enable

Enable/Disable PCIE Native Control reported in ACPI Table.

Native ASPM

Choose ASPM feature is controlled by OS or BIOS.

4.1.2.2 CPU Configuration

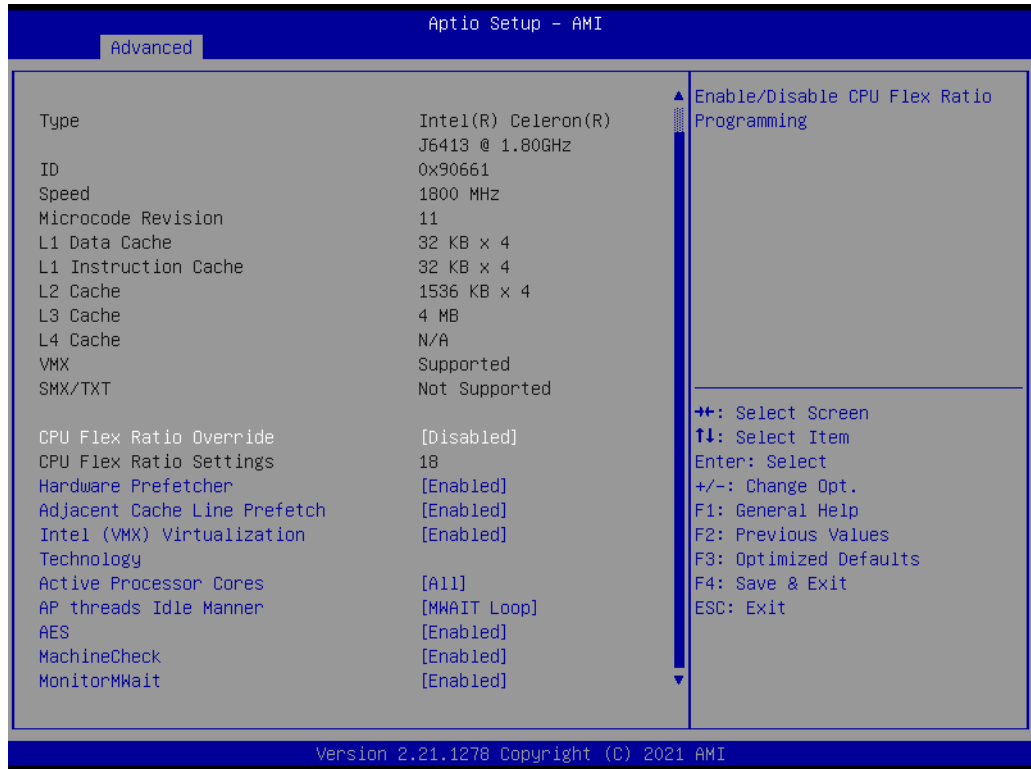

CPU Flex Ratio Override

Enable/Disable CPU Flex Ratio Programming.

Hardware Prefetcher

This item allows users to enable or disable the hardware prefetcher feature.

Adjacent Cache Line Prefetch

This item allows users to enable or disable the adjacent cache line prefetch feature.

Intel (VMX) Virtualization Technology

When Enabled, a VMM can utilize the additional hardware capability provided by Vanderpool Technology.

Active Processor Cores

This item allows users to set how many processor cores should be active.

AP threads Idle Manner

AP threads Idle Manner for waiting signal to run.

AES

Enable/Disable AES (Advanced Encryption Standard).

MachineCheck

Enable/Disable Machine Check.

MonitorMWait

Enable/Disable MonitorMWait.

4.1.2.3 Power & Performance



CPU – Power Management Control

CPU – Power Management Control Options.

GT – Power Management Control

GT – Power Management Control Options.

CPU - Power Management Control

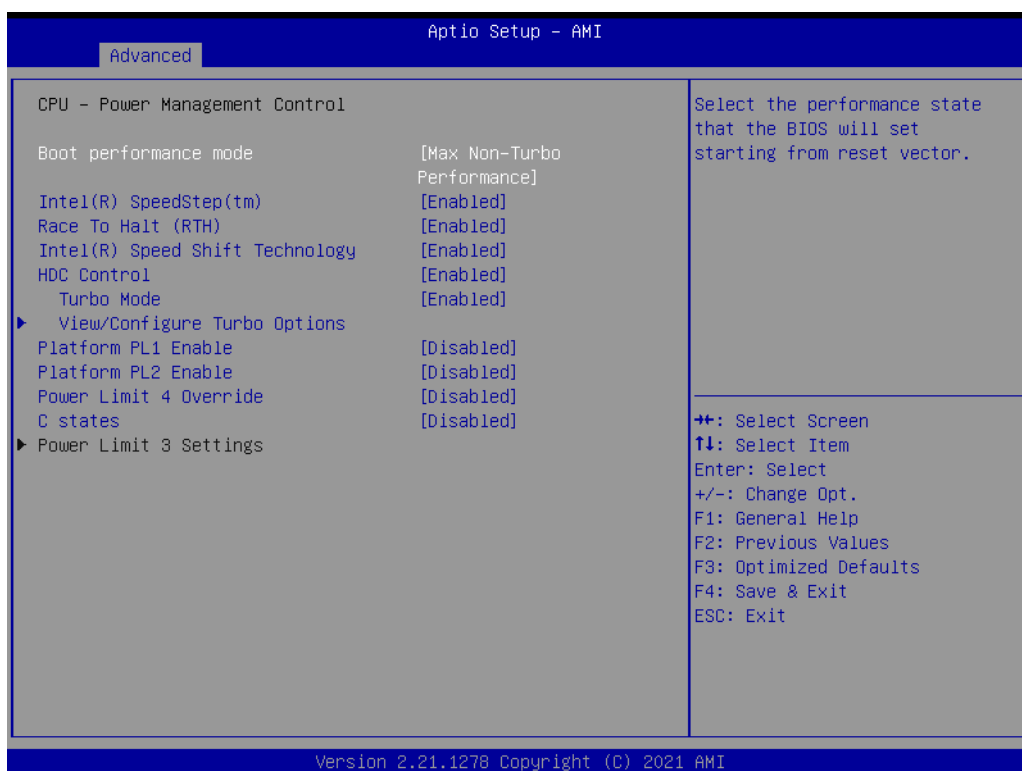

Boot Performance mode

Select the performance state that the BIOS will set before OS handoff.

Intel® SpeedStep®

Allows more than two frequency ranges to be supported.

Race to Halt (RTH)

Enable/Disable Race to Halt feature. RTH will dynamically increase CPU frequency in order to enter pkg C-State faster to reduce overall power.

Intel® Speed Shift Technology

Enable/Disable Intel® Speed Shift Technology support.

HDC Control

Enable/Disable Intel HDC.

Turbo Mode

Enable/Disable processor turbo mode.

View/Configure Turbo Options

View and Configure Turbo Options.

Platform PL1 Enable

Enable/Disable Platform Power Limit 1 programming.

Platform PL2 Enable

Enable/Disable Platform Power Limit 1 programming.

Power Limit 4 Override

Enable/Disable Power Limit 4 override.

C states

Enable/Disable CPU Power Management.

PowerLimit 3 Settings

Power Limit 3 Settings.

■ View/Configure Turbo Options

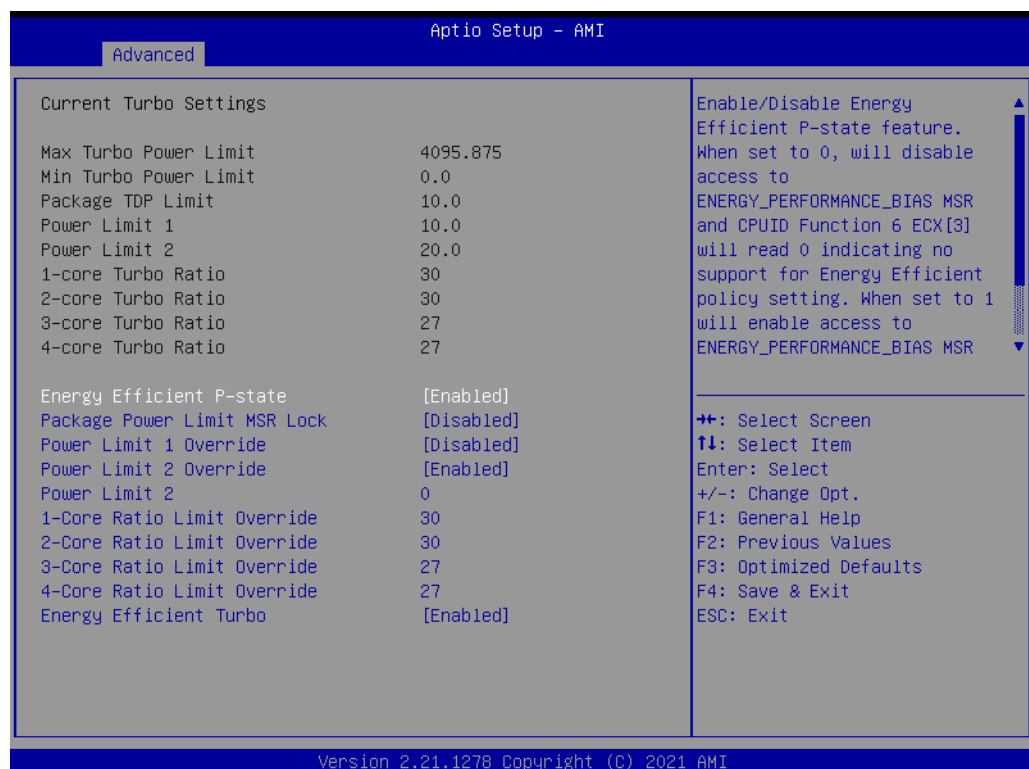

Energy Efficient P-state

Enable/Disable Energy Efficient P-state feature.

Package Power Limit MSR Lock

Enable/Disable locking of Package Power Limit 1 settings.

Power Limit 1 Override

Enable/Disable Power Limit 1 override.

Power Limit 2 Override

Enable/Disable locking of Package Power Limit 2 settings.

Power Limit 2

Power Limit 2 value in Milli Watts.

1-Core Turbo Ratio Limit Ratio (TRLR) Override

1-Core Turbo Ratio Limit Ratio (TRLR).

2-Core Turbo Ratio Limit Ratio (TRLR) Override

2-Core Turbo Ratio Limit Ratio (TRLR).

3-Core Turbo Ratio Limit Ratio (TRLR) Override

3-Core Turbo Ratio Limit Ratio (TRLR).

4-Core Turbo Ratio Limit Ratio (TRLR) Override

4-Core Turbo Ratio Limit Ratio (TRLR).

Energy Efficient Turbo

Enable/Disable Energy Efficient Turbo feature.

■ Power Limit 3 Settings

**Power Limit 3 Override**

Enable/Disable Power Limit 3 override.

■ GT - Power Management Control

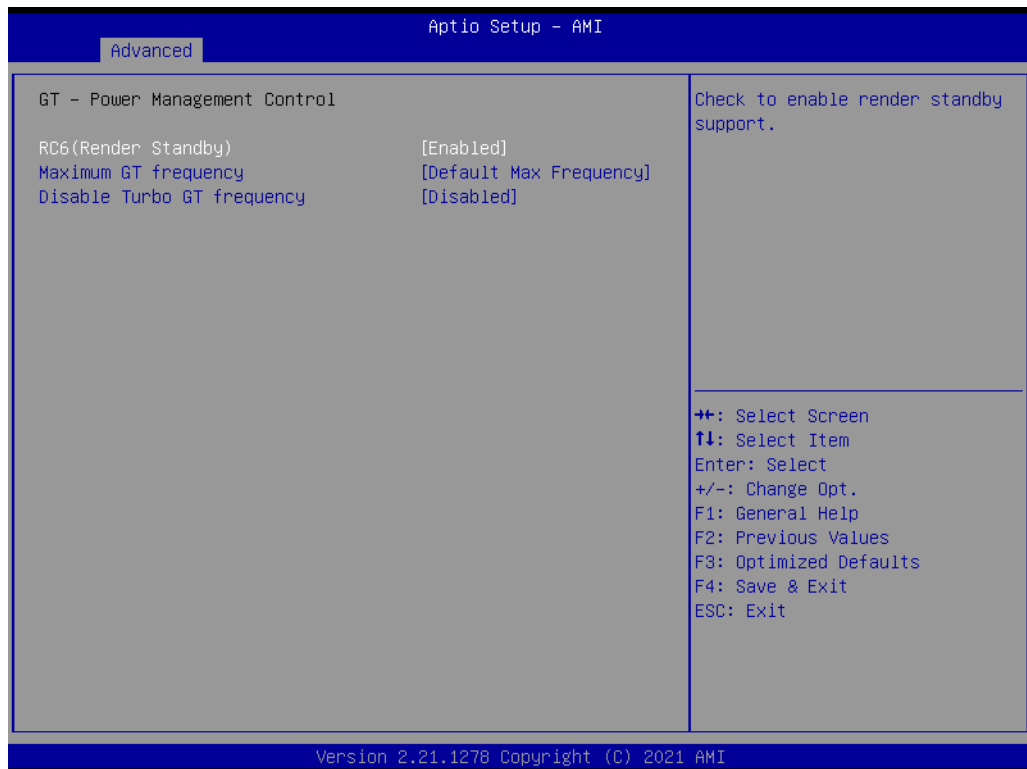

RC6(Render Standby)

Check to enable render standby support.

Maximum GT frequency

Maximum GT frequency limited by user.

Disable Turbo GT frequency

Enabled/Disabled Turbo GT frequency.

4.1.2.4 PCH-FW Configuration

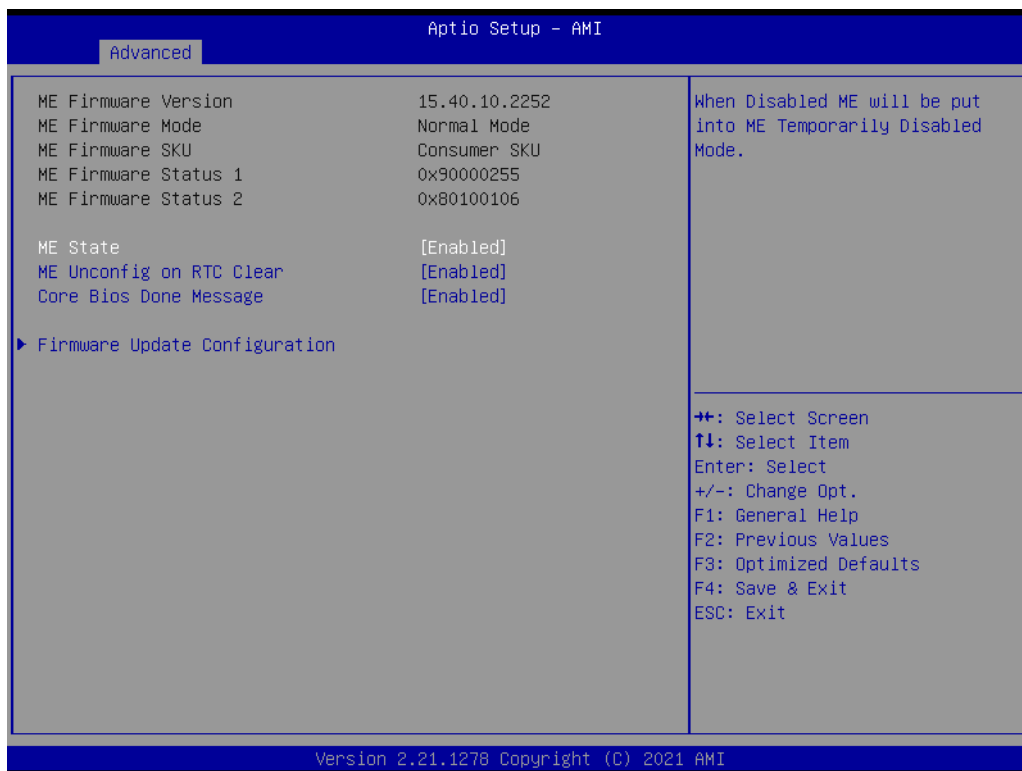

ME State

When Disabled, ME will be put ME into Temporarily Disabled Mode.

ME Unconfig on RTC Clear

When Disabled, ME will not be unconfigured on RTC Clear.

Core BIOS Done Message

Enable/Disable Core BIOS Done message sent to ME.

Firmware Update Configuration

Configure Management Engine Technology Parameters.

4.1.2.5 ACPI Settings

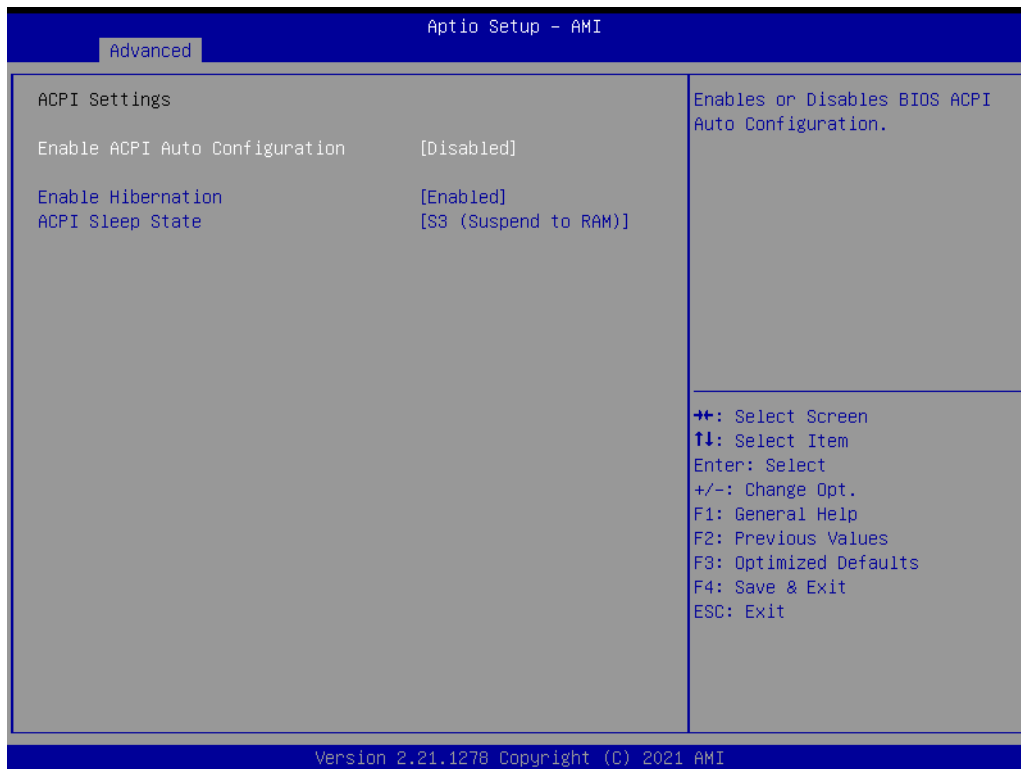

Enable ACPI Auto Configuration

Enable or disable BIOS ACPI auto configuration.

Enable Hibernation

Enables or disables the ability to hibernate (OS/S4 Sleep State). This option may not be effective with some OS.

ACPI Sleep State

Select the highest ACPI sleep state the system will enter when the SUSPEND button is pressed.

Lock Legacy Resources

Enables or disables lock of Legacy Resources.

S3 Video Repost

Enable or disable S3 Video Repost.

4.1.2.6 NCT6126D Super IO Configuration

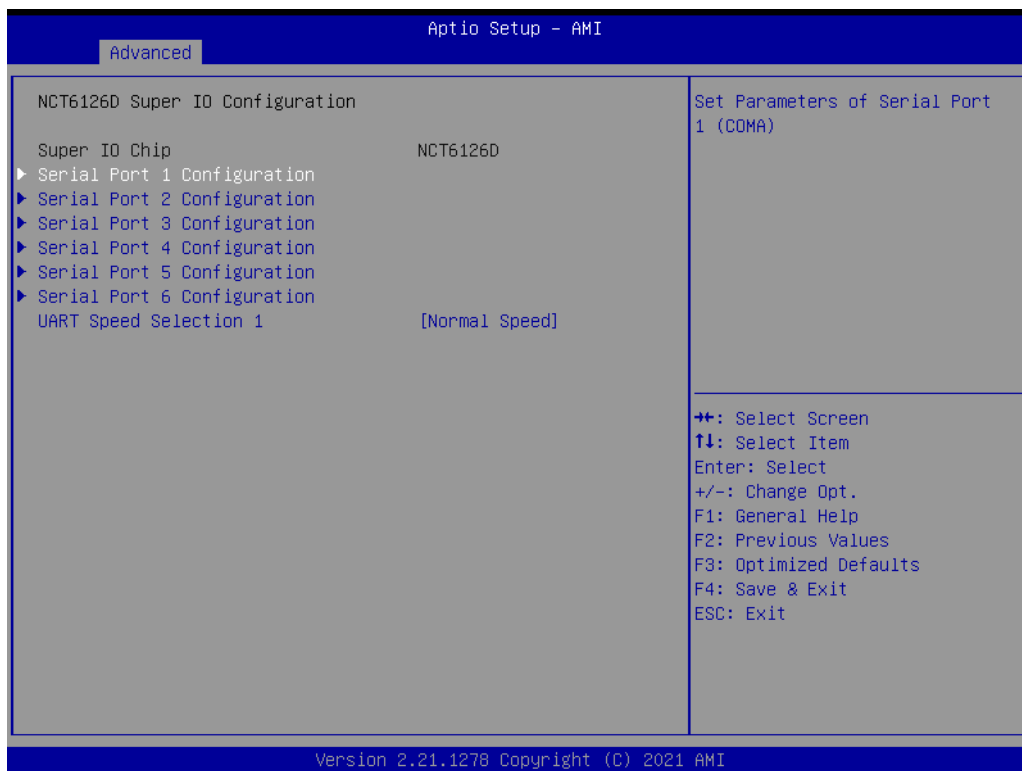

Serial Port 1 Configuration

Set Parameters of Serial Port 1.

Serial Port 2 Configuration

Set Parameters of Serial Port 2.

Serial Port 3 Configuration

Set Parameters of Serial Port 3.

Serial Port 4 Configuration

Set Parameters of Serial Port 4.

Serial Port 5 Configuration

Set Parameters of Serial Port 5.

Serial Port 6 Configuration

Set Parameters of Serial Port 6.

UART Speed Selection 1

COM1, COM2 Speed Selection.

Serial Port 1 Configuration

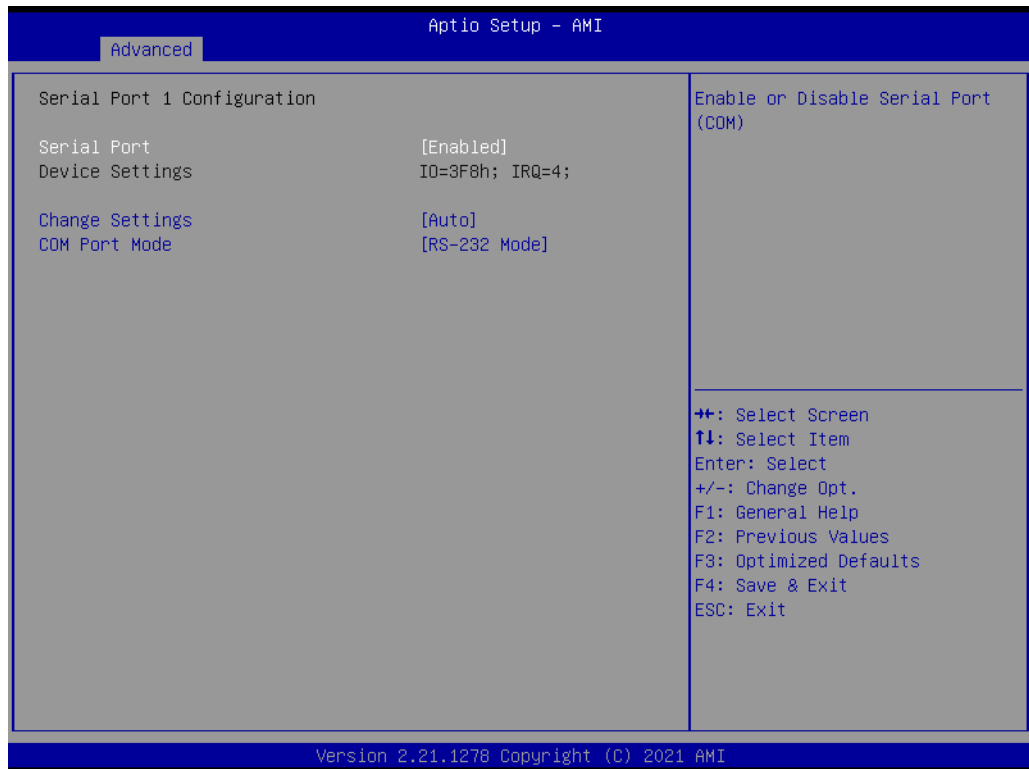

Serial Port

Enable or disable Serial Port (COM).

Change Settings

Select an optimal settings for Super IO device.

COM Mode

COM port mode select.

Serial Port 2 Configuration

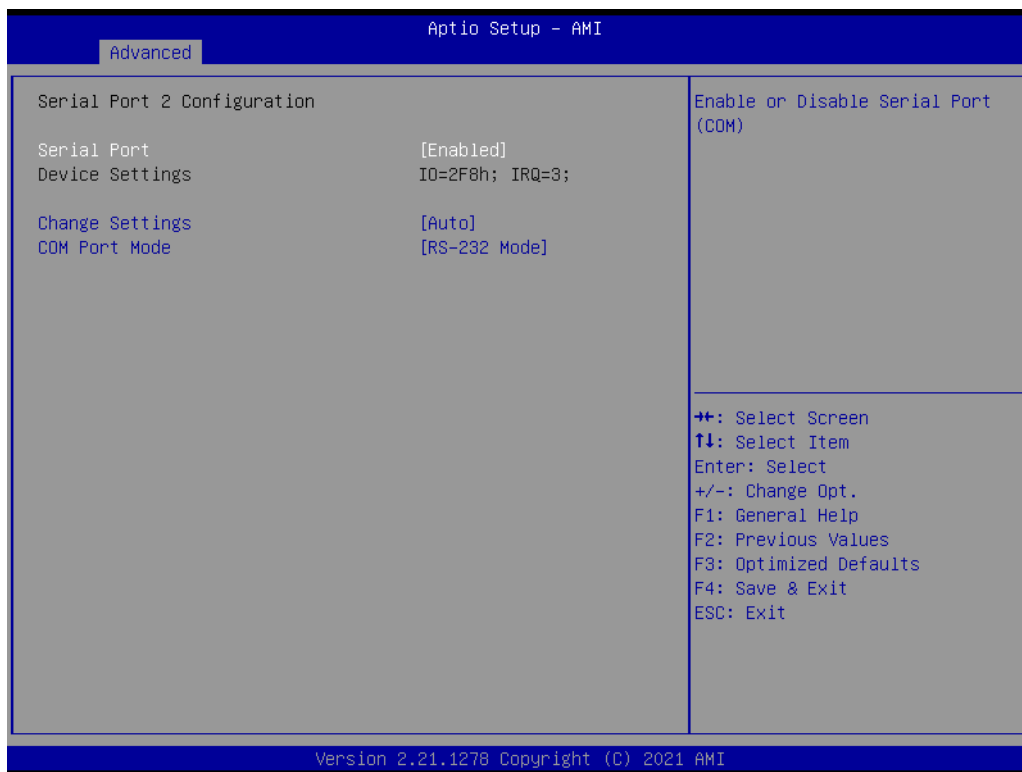

Serial Port

Enable or disable Serial Port (COM).

Change Settings

Select an optimal settings for Super IO device.

COM Mode

COM port mode select.

Serial Port 3 Configuration

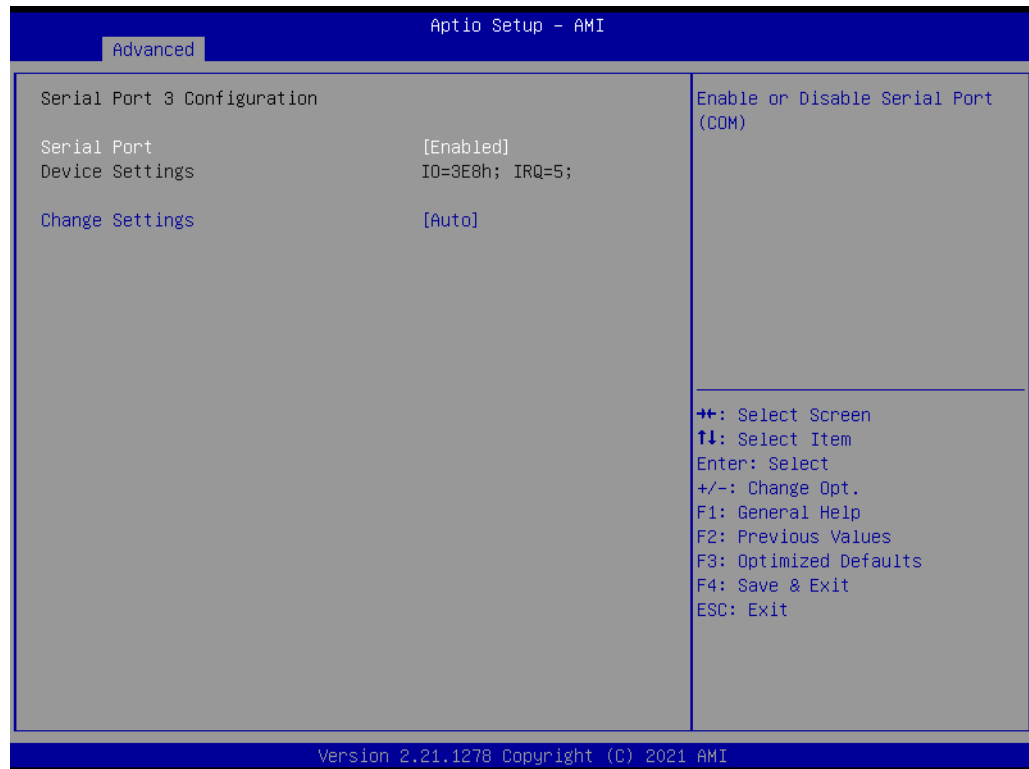

Serial Port

Enable or disable Serial Port (COM).

Change Settings

Select an optimal settings for Super IO device.

Serial Port 4 Configuration

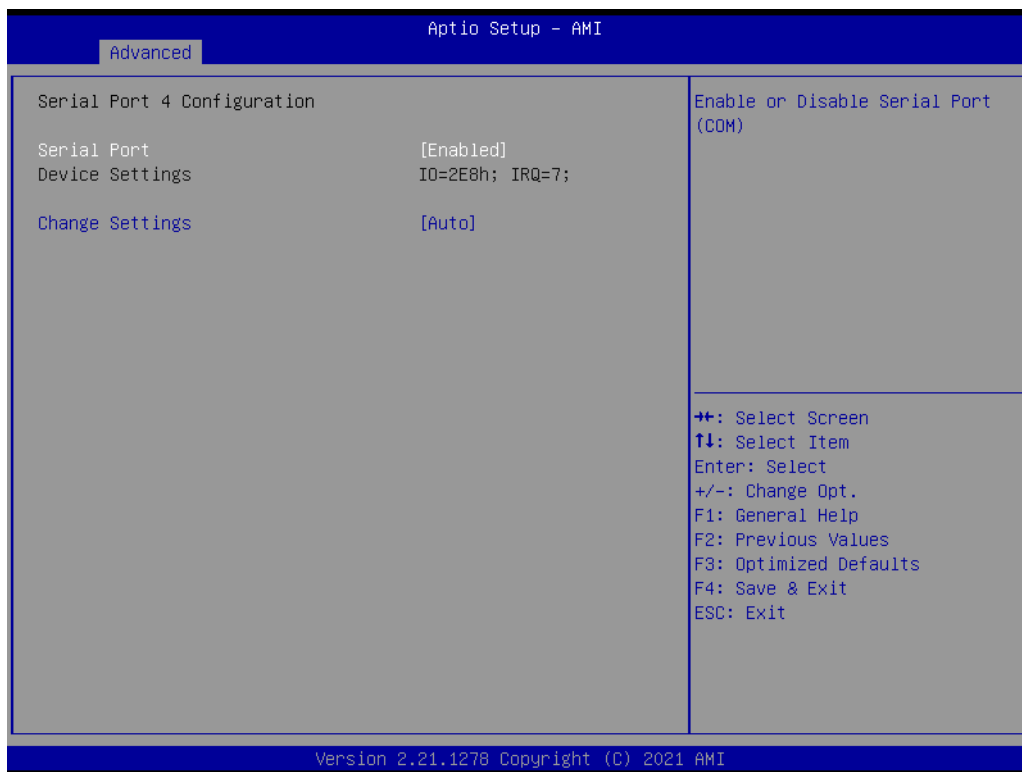

Serial Port

Enable or disable Serial Port (COM).

Change Settings

Select an optimal settings for Super IO device.

Serial Port 5 Configuration

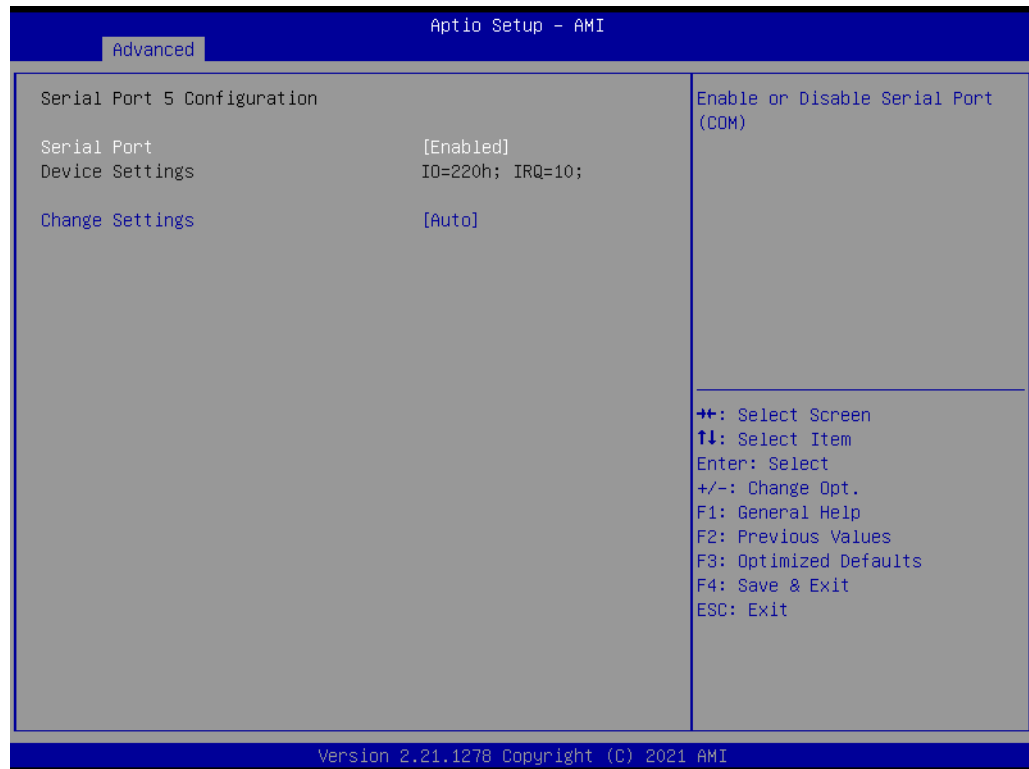

Serial Port

Enable or disable Serial Port (COM).

Change Settings

Select an optimal settings for Super IO device.

Serial Port 6 Configuration

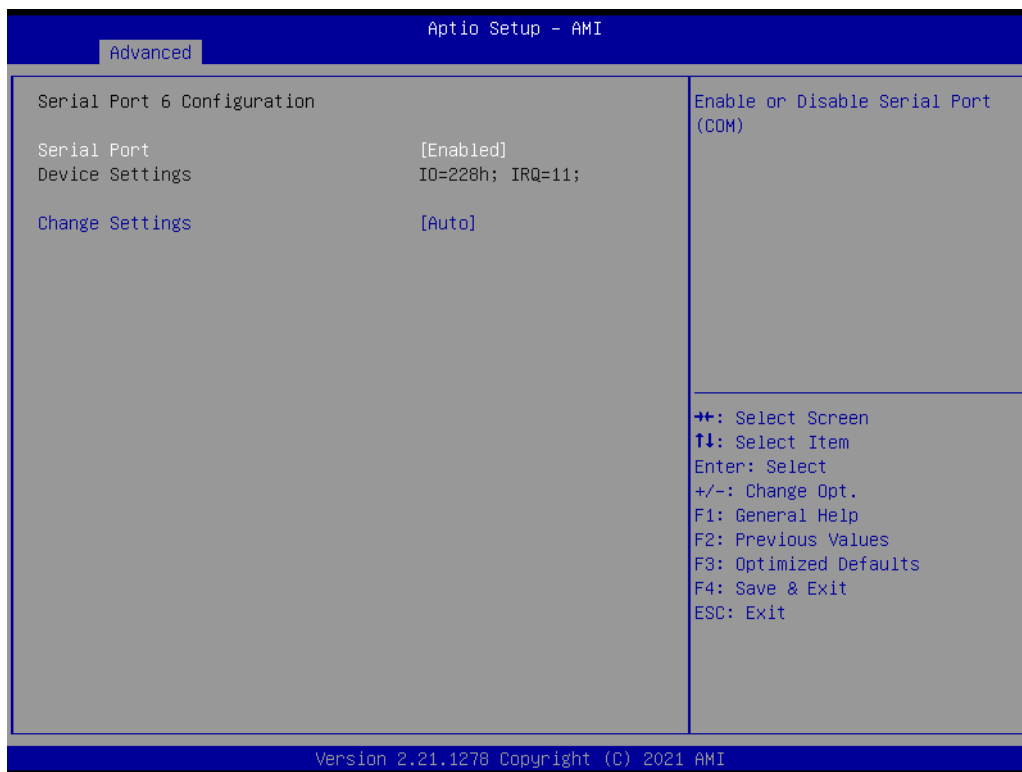

Serial Port

Enable or disable Serial Port (COM).

Change Settings

Select an optimal settings for Super IO device.

4.1.2.7 NCT6126D HW Monitor

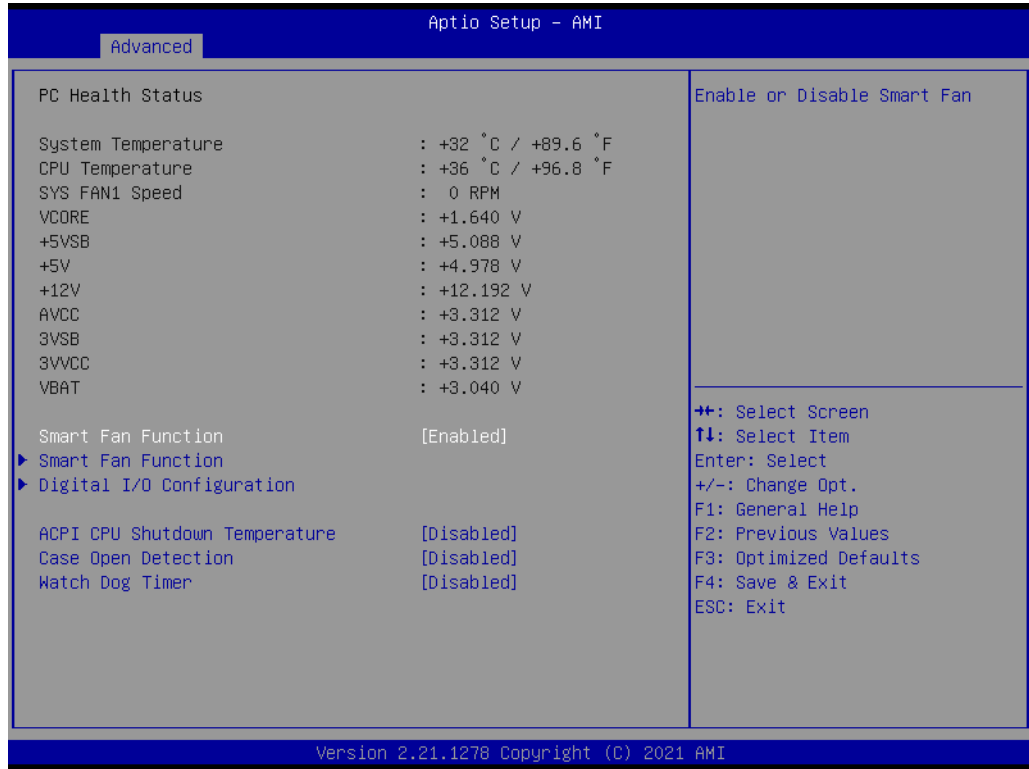

Smart Fan Function

Enable or Disable Smart Fan.

Smart Fan Function

Enable or Disable Smart Fan.

Digital I/O Configuration

Configure the digital I/O Pins.

ACPI CPU Shutdown Temperature

Select the Critical Temperature value that OSPM must shutdown the system.

Case Open Detection

Enable or Disable Case Open Detect Function.

Watch Dog Timer

Enable or Disable Watch Dog Timer Function.

Smart Fan Function

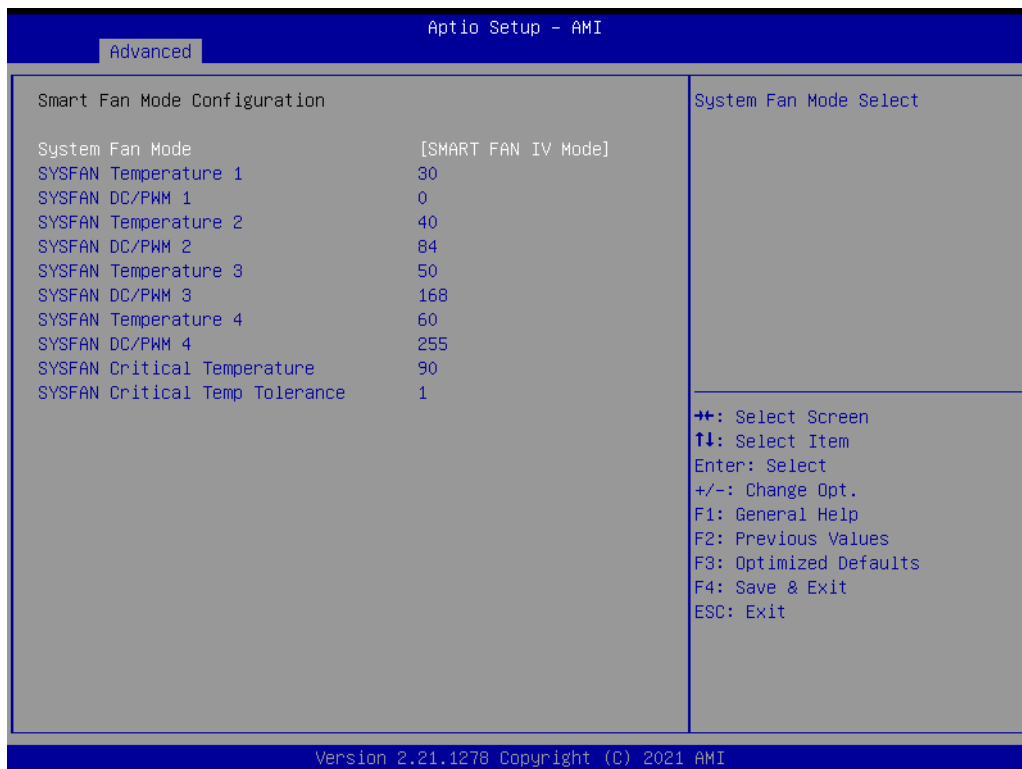

System Fan Mode

System Fan Mode Select.

SYSFAN Temperature 1

Input the System Smart Fan IV Temperature 1.

SYSFAN DC/PWM 1

Input the System Smart Fan IV DC/PWM 1 Value.

SYSFAN Temperature 2

Input the System Smart Fan IV Temperature 2.

SYSFAN DC/PWM 2

Input the System Smart Fan IV DC/PWM 2 Value.

SYSFAN Temperature 3

Input the System Smart Fan IV Temperature 3.

SYSFAN DC/PWM 3

Input the System Smart Fan IV DC/PWM 3 Value.

SYSFAN Temperature 4

Input the System Smart Fan IV Temperature 4.

SYSFAN DC/PWM 4

Input the System Smart Fan IV DC/PWM 4 Value.

SYSFAN Critical Temperature

Input the System Smart Fan IV Critical Temperature.

SYSFAN Critical Temp Tolerance

Input Tolerance of Critical Temperature. (Range:0 - 7)

Digital I/O Configuration

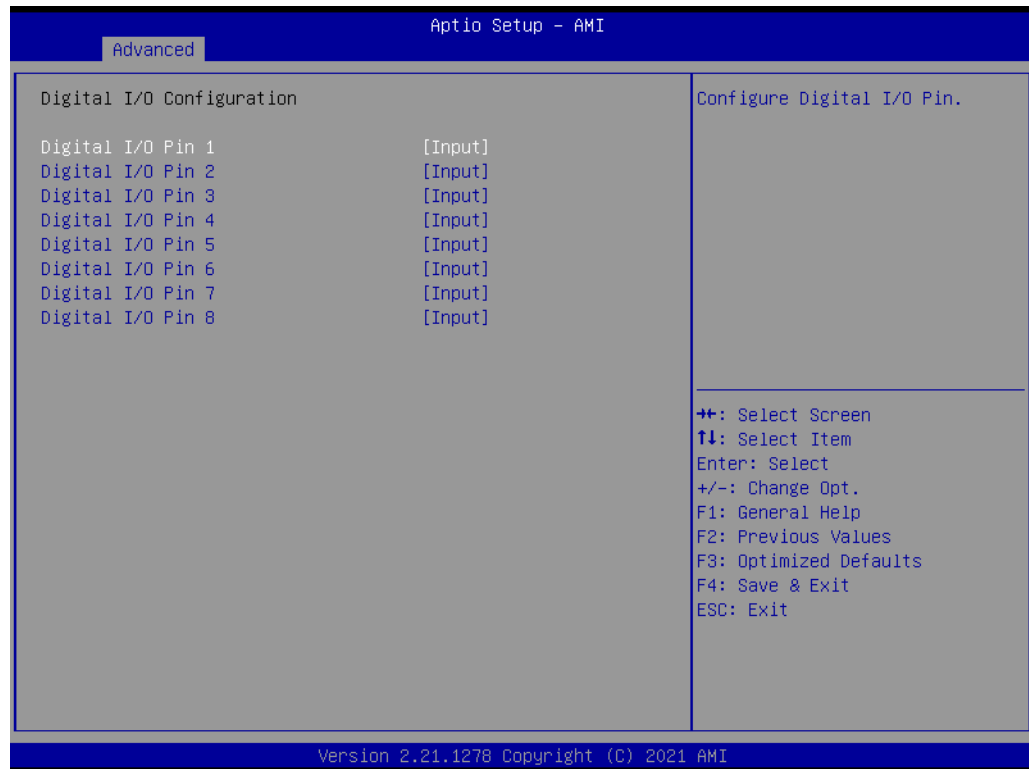

Digital I/O Pin 1/2/3/4/5/6/7/8
Configure Digital I/O Pin.

4.1.2.8 Trusted Computing



Security Device Support

Enable or disable BIOS support for security device.

SHA-1 PCR Bank

Enable or disable SHA-1 PCR Bank.

SHA256 PCR Bank

Enable or disable SHA256 PCR Bank.

SHA384 PCR Bank

Enable or Disable SHA384 PCR Bank.

Pending operation

Schedule an operation for the security device.

Platform Hierarchy

Enable or disable Platform Hierarchy.

Storage Hierarchy

Enable or disable Storage Hierarchy.

Endorsement Hierarchy

Enable or disable Endorsement Hierarchy.

TPM 2.0 UEFI Spec Version

Select the TCG2 Spec Version support.

Physical Presence Spec Version

Select to Tell O.S. to support PPI Spec Version 1.2 or 1.3.

Device Select

TPM 1.2 will restrict support to TPM 1.2 devices, TPM 2.0 will restrict support to TPM 2.0 devices.

4.1.2.9 S5 RTC Wake Settings

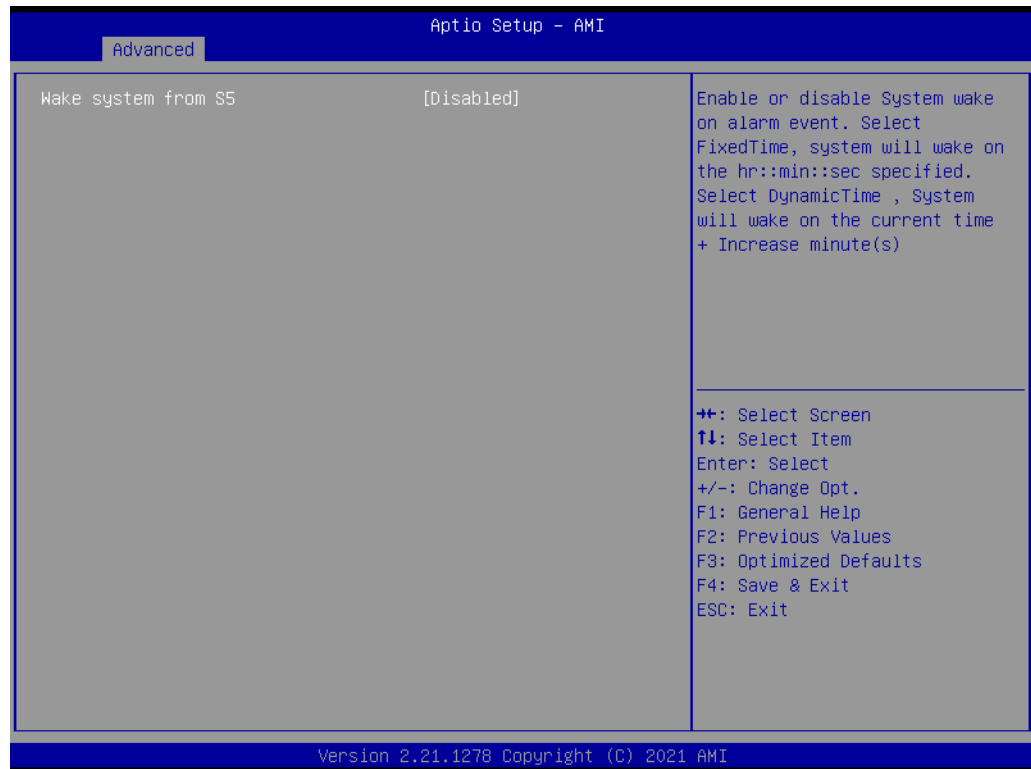

Wake system from S5

Enable or disable System wake on alarm event. Select FixedTime, system will wake on the hr:min:sec specified.

4.1.2.10 Serial Port Console Redirection



Console Redirection

This item allows users to enable or disable console redirection for Microsoft Windows Emergency Management Services (EMS).

Console Redirection Settings

This item allows users to configure console redirection detail settings.

4.1.2.11 USB Configuration



Legacy USB Support

Enables Legacy USB support. AUTO option disables legacy support if no USB devices are connected. DISABLE option will keep USB devices available only for EFI applications.

XHCI Hand-off

This is a workaround for OS without XHCI hand-off support. The XHCI ownership change should be claimed by XHCI driver.

USB Mass Storage Driver Support

Enable/disable USB Mass Storage Driver Support.

USB Transfer Time-out

Time-out value for control, bulk, and interrupt transfers.

Device Reset Time-out

USB mass storage device start unit command time-out.

Device Power-up Delay

Maximum time the device will take before it properly reports itself to the host controller. 'Auto' uses default value: for a root port it is 100 ms, for a Hub port the delay is taken from hub descriptor.

4.1.2.12 Network Stack Configuration



Network Stack

Enable/Disable UEFI Network Stack.

4.1.2.13 NVMe Configuration

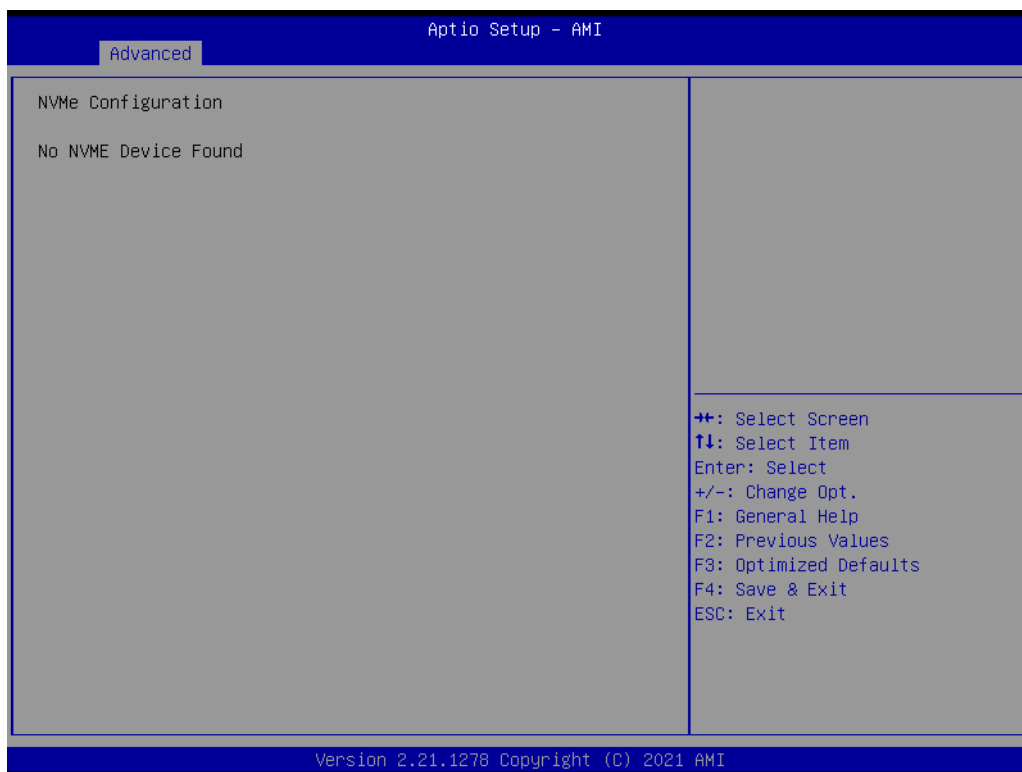

4.1.3 Chipset Configuration

Select the Chipset tab from the MIO-5152 setup screen to enter the Chipset BIOS Setup screen. You can display a Chipset BIOS Setup option by highlighting it using the <Arrow> keys. All Plug and Play BIOS Setup options are described in this section. The Plug and Play BIOS setup screen is shown below.



4.1.3.1 System Agent (SA) Configuration

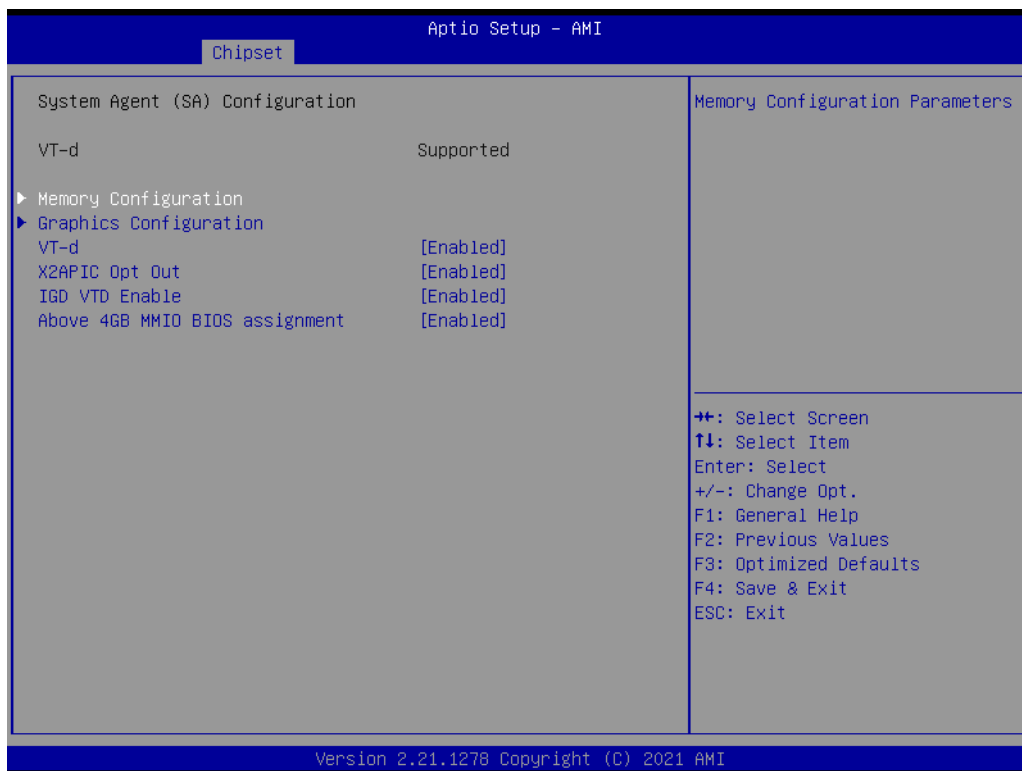

Memory Configuration

Memory Configuration parameters.

Graphics Configuration

Graphics Configuration parameters.

VT-d

VT-D capability.

X2APIC Opt Out

Enable/Disable X2APIC Opt Out Bit.

IGD VTD Enable

Enable/Disable IGD VTD.

Above 4GB MMIO BIOS assignment

Enable/Disable above 4GB Memory Mapped IO BIOS assignment.

Memory Configuration

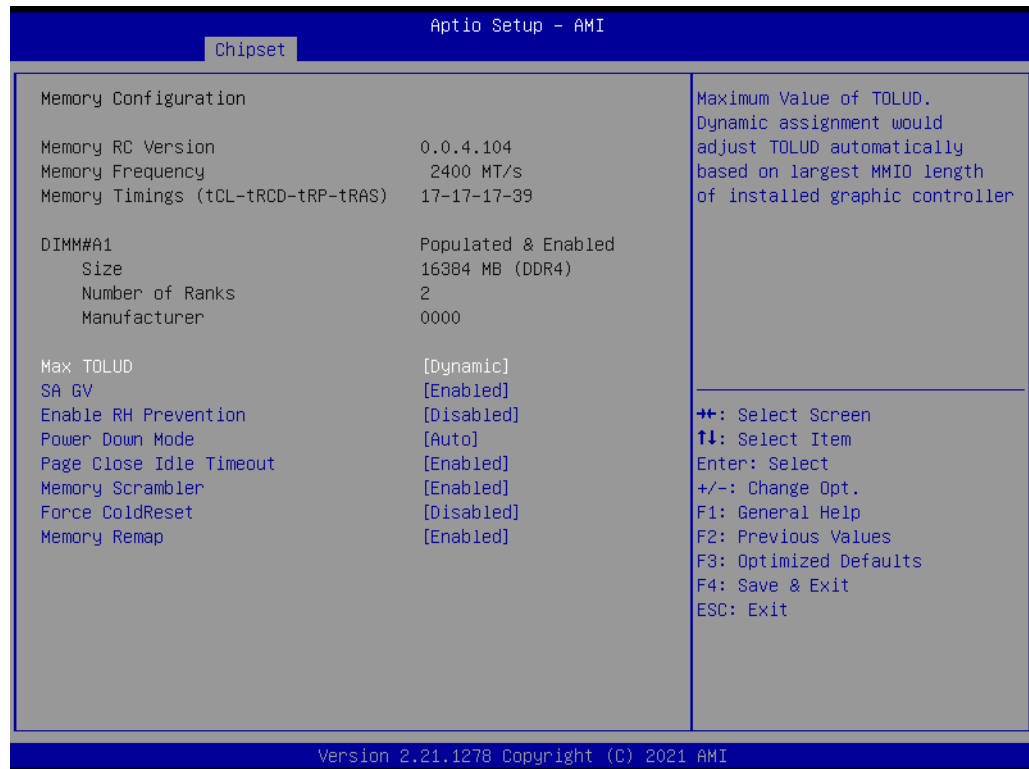

Max TOLUD

Maximum value of TOLUD.

SA GV

System Agent Geyserville.

Enable RH Prevention

Actively prevent Row Hammer.

Power Down Mode

CKE Power Down Mode Control.

Page Close Idle Timeout

Page Close Idle Timeout Control.

Memory Scrambler

Enable/Disable Memory Scrambler support.

Force ColdReset

Force ColdReset OR Choose MrcColdBoot mode.

Memory Remap

Enable/Disable Memory Remap above 4GB.

Graphics Configuration

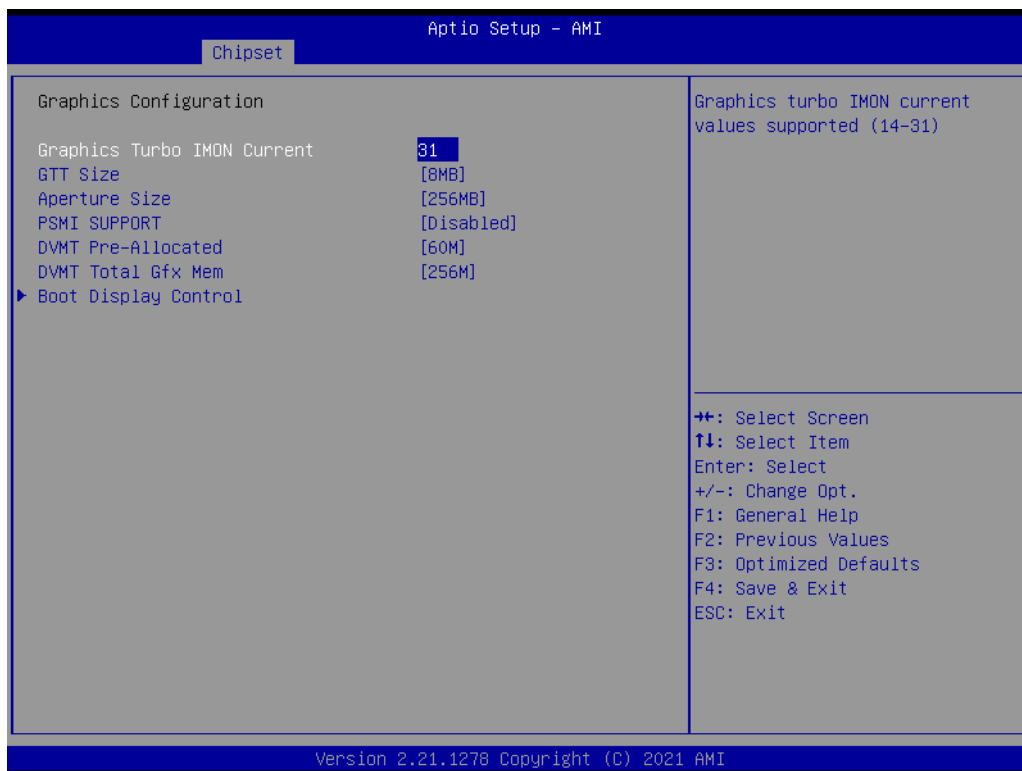

Graphics Turbo IMON Current

Graphics turbo IMON current values supported.

GTT Size

Select the GTT Size.

Aperture Size

Select the Aperture Size.

PSMI Support

Enable/Disable PSMI.

DVMT Pre-Allocated

Select DVMT 5.0 Pre-Allocated (Fixed) Graphics Memory size used by the Internal Graphics Device.

DVMT Total Gfx Mem

Select DVMT 5.0 Total Graphic Memory size used by the Internal Graphics Device.

Boot Display Control

Boot Display Control.

Boot Display Control

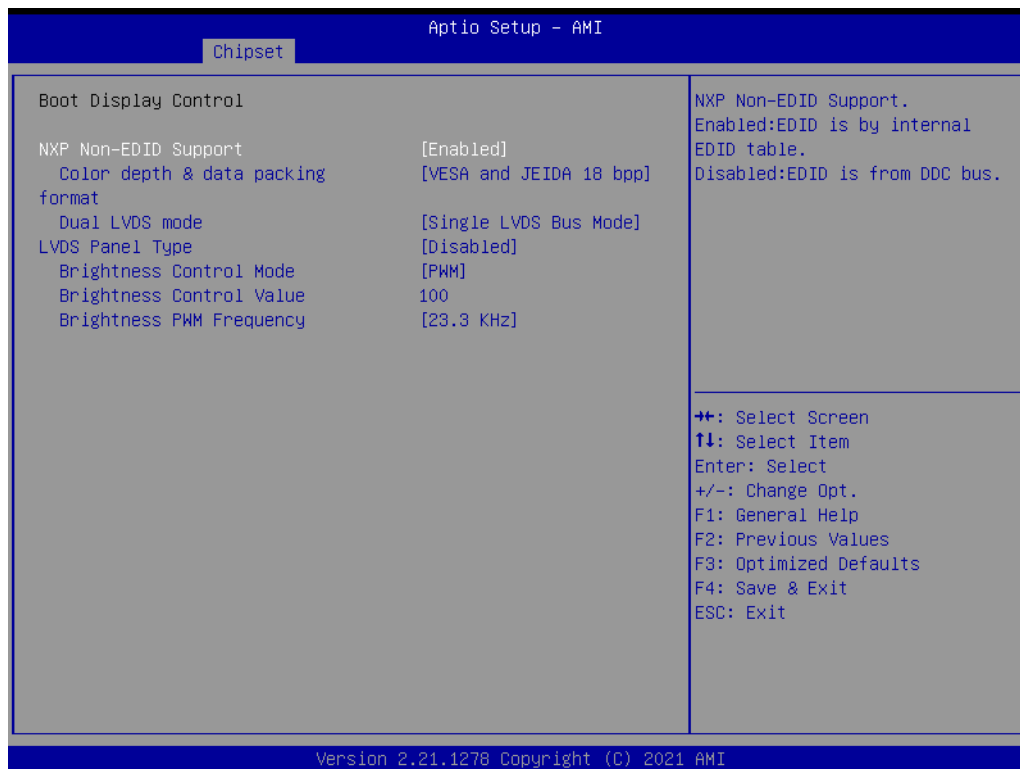

NXP Non-EDID Support

NXP non-EDID support.

Color Depth & Data Packing

Color depth and data packing format for Non-EDID support.

Dual LVDS Mode

Select LVDS bus to single bus mode or dual bus mode.

LVDS Panel Type

This item allow user to select LVDS panel resolution type.

Brightness Control Mode

Switch Brightness Control to Linear or PWM mode.

Brightness Control Value

Choose to override LVDS brightness value during POST stage. Value from 0 ~ 100.

Brightness PWM Frequency

Adjust LVDS Brightness PWM Frequency.

4.1.3.2 PCH-IO Configuration

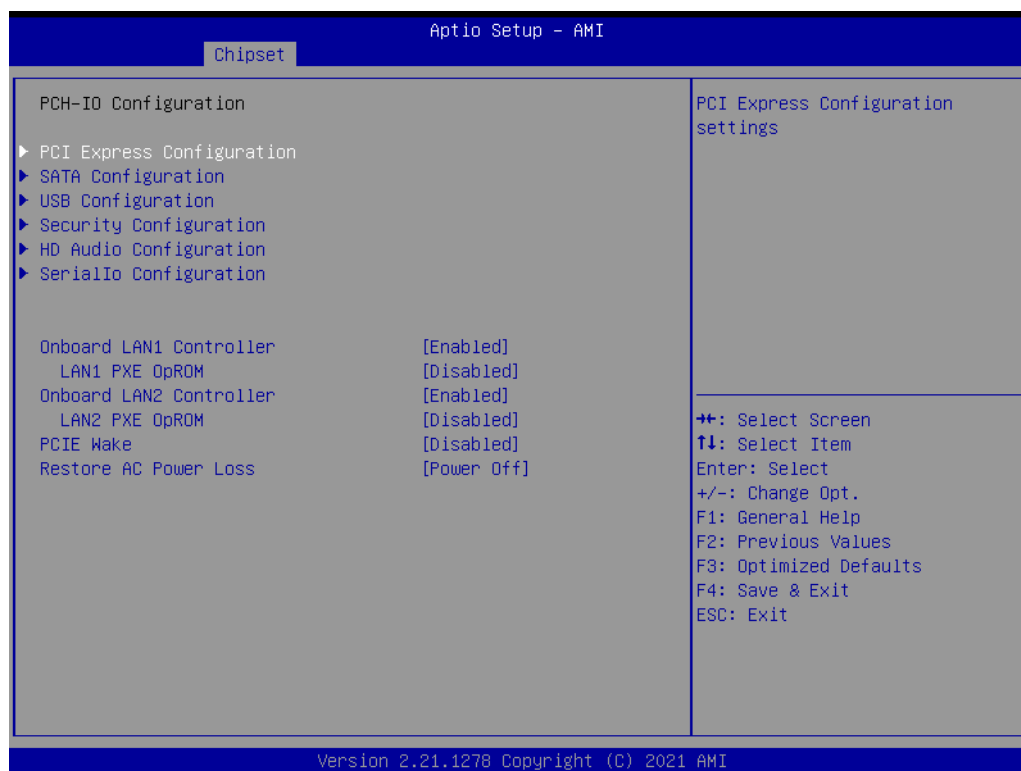

PCI Express Configuration

PCI Express Configuration settings.

SATA Configuration

SATA device options settings.

USB Configuration

USB Configuration settings.

Security Configuration

Security Configuration settings.

HD Audio Configuration

HD Audio subsystem configuration settings.

SerialIO Configuration

SerialIO configuration settings.

Onboard LAN1 Controller

Select to Enable or Disable Onboard LAN1 Controller.

LAN1 PXE ROM

Enable or Disable onboard LAN1's PXE option ROM.

Onboard LAN2 Controller

Select to Enable or Disable Onboard LAN2 Controller.

LAN2 PXE ROM

Enable or Disable onboard LAN2's PXE option ROM.

PCIE Wake

Enable or Disable PCIE to wake the system from S5.

Restore AC Power Loss

Specify what state to go to when power is re-applied after a power failure (G3 state).

PCI Express Configuration

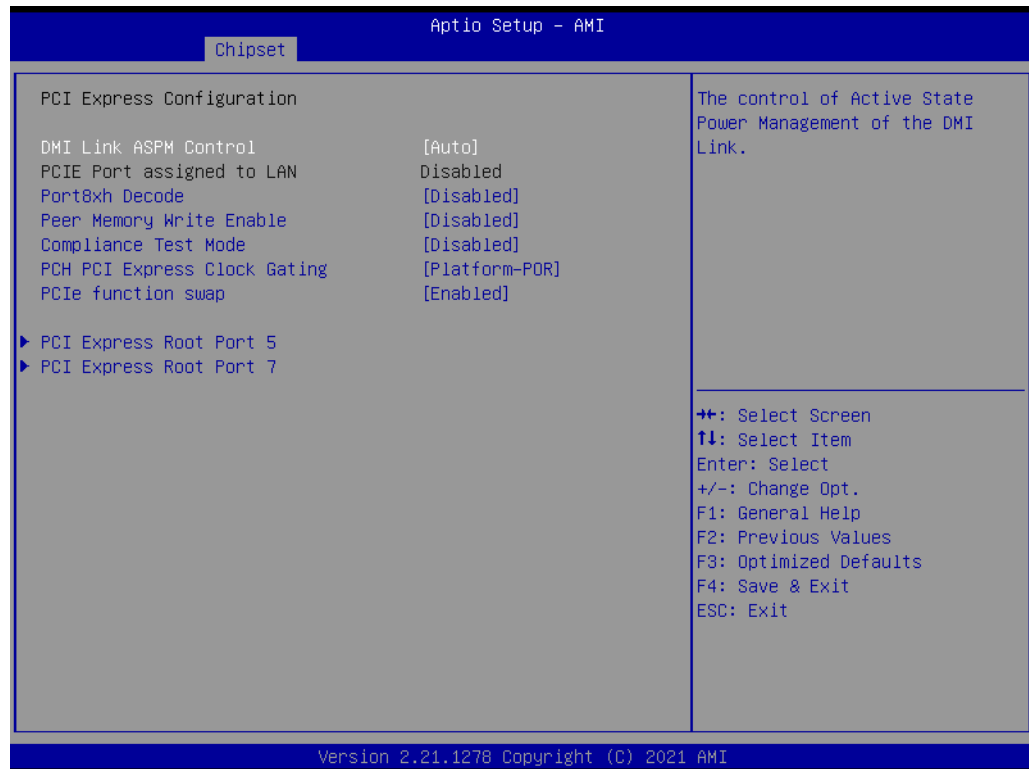

DMI Link ASPM Control

This item controls Active State Power Management of the DMI Link.

Port8xh Decode

PCI Express Port8xh Decode Enable/Disable.

Peer Memory Write Enable

Peer Memory Write Enable/Disable.

PCH PCI Express Clock Gating

Enable/Disable PCH PCI Express Clock Gating For Each Root Port.

PCIe function swap

When Disabled, prevents PCIe root port function swap. If any function other than 0th is enabled, 0th will become visible.

PCI Express Root Port 5/7

PCI Express Port 5/7 Settings.

SATA Configuration

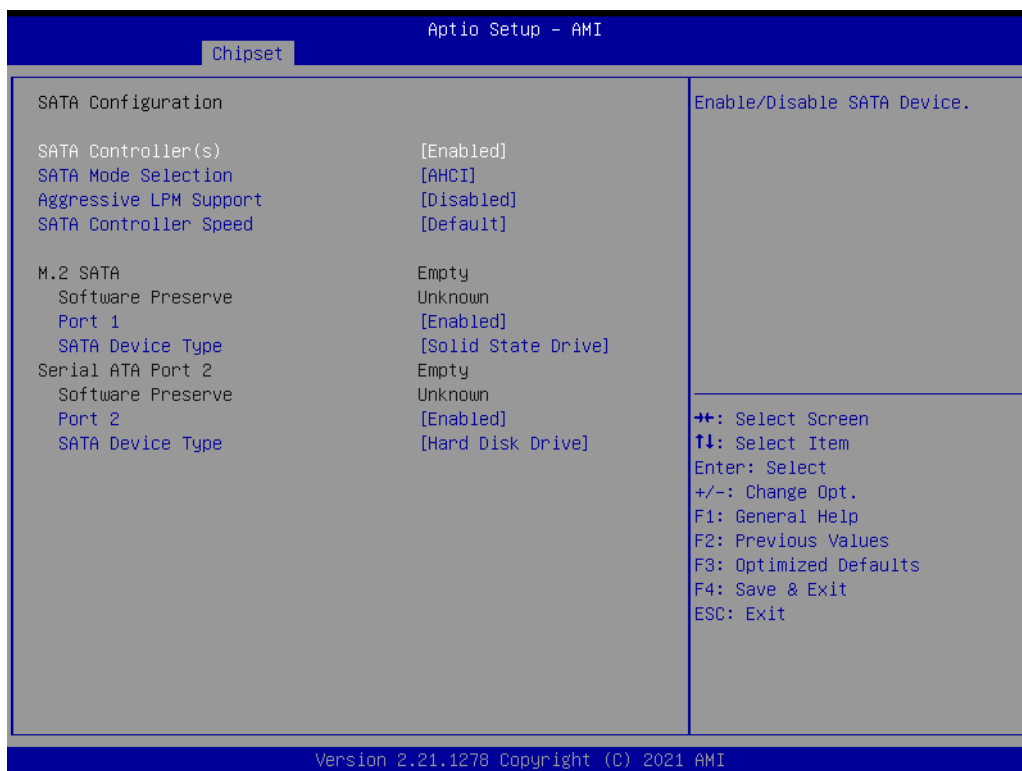

SATA Controller(s)

Enable/disable SATA device.

SATA Mode Selection

Determine how SATA controller operate.

Aggressive LPM Support

Enabled PCH to aggressively enter link power state.

SATA Controller Speed

Indicates the maximum speed the SATA controller can support.

USB Configuration

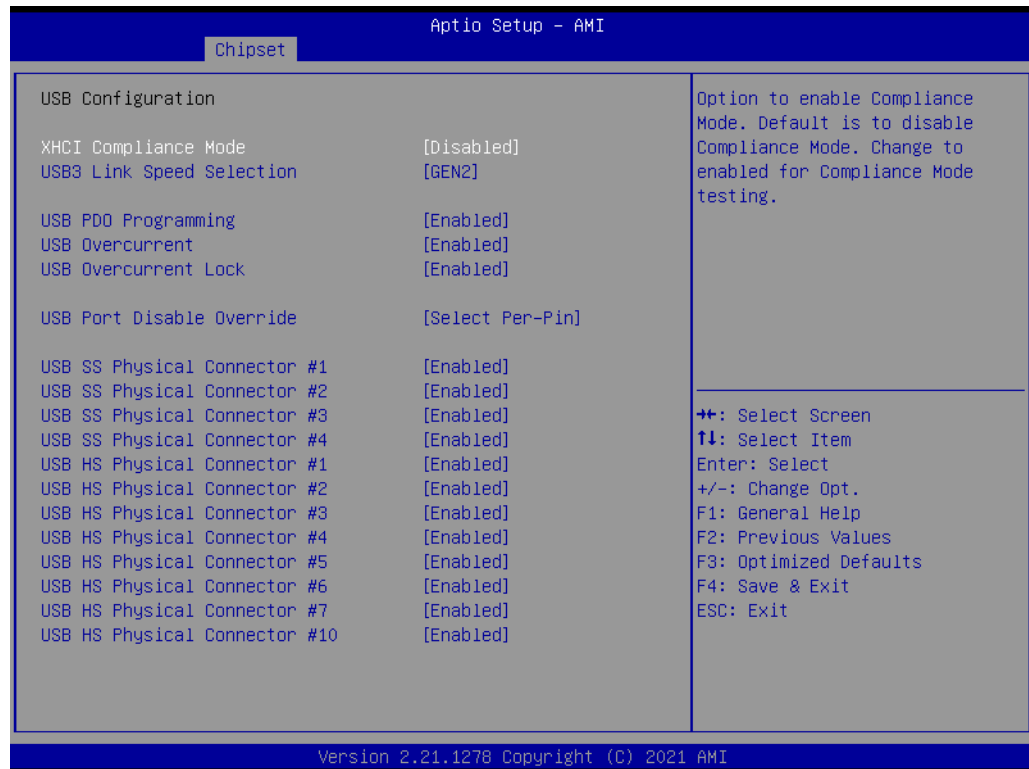

XHCI Compliance Mode

Option to enable Compliance Mode.

USB3 Link Speed Selection

This option is to select USB3 Link Speed GEN1 or GEN2.

USB PDO Programming

Select "Enabled" if Port Disable Override functionality is used.

USB Overcurrent

Select "Disabled" for pin-based debug.

USB Overcurrent Lock

Select "Enabled" if Overcurrent functionality is used.

USB Port Disable Override

Selectively Enable/Disable the corresponding USB Port from reporting a Device Connection to the Controller.

USB SS Physical Connector #1/2/3/4

Enable/Disable this USB Physical Connector.

USB HS Physical Connector #1/2/3/4/5/6/7/10

Enable/Disable this USB Physical Connector.

Security Configuration



RTC Memory Lock

Enable will lock bytes 38h-3Fh in the lower/upper 128-byte bank of RTC RAM.

BIOS Lock

Enable or Disable the PCH BIOS Lock Enable feature.

Force unlock on all GPIO pads

If Enabled BIOS will force all GPIO pads to be in unlock state.

HD Audio Configuration

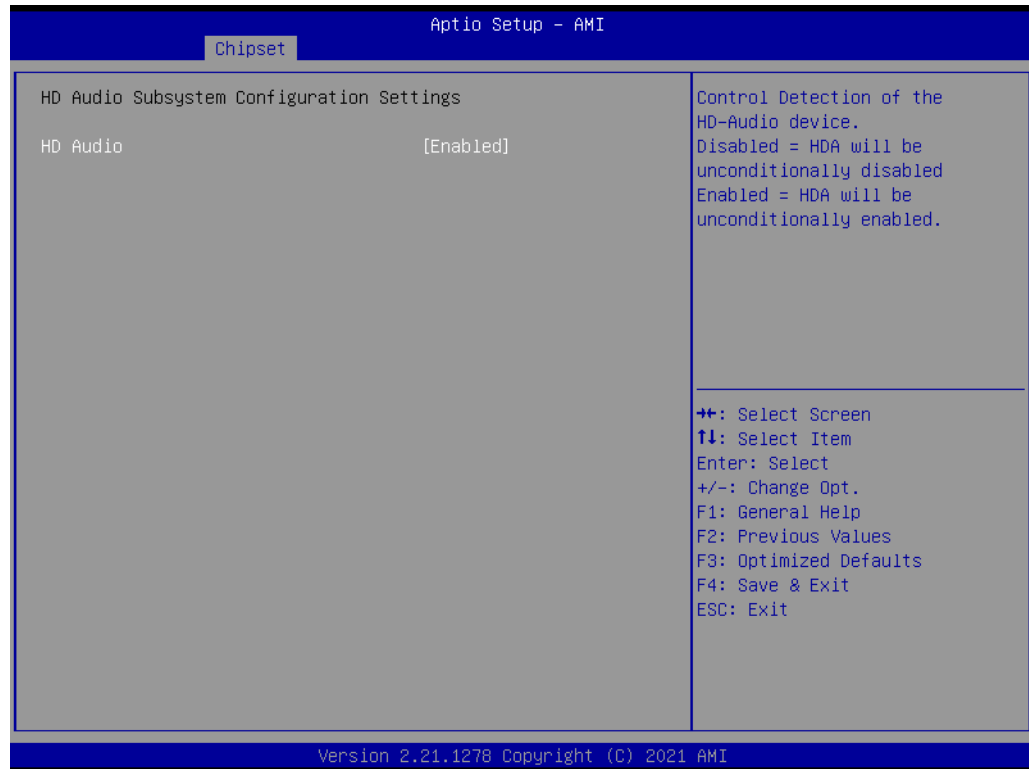

HD Audio

Control detection of the HD-Audio device. Disabled = HDA will be unconditionally disabled. Enabled = HDA will be unconditionally enabled.

Serial IO Configuration

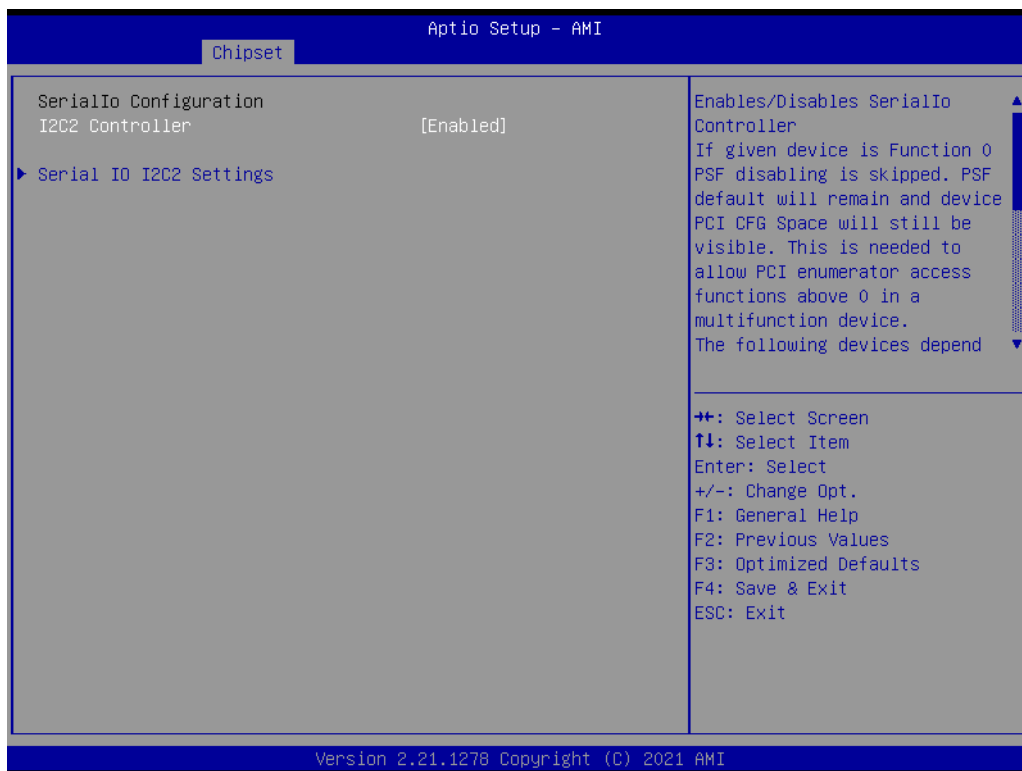

I2C0 Controller

Enable/Disables Serial IO Controller.

4.1.4 Security



Select security setup from the MIO-5152 setup main BIOS setup menu. All Security setup options, such as password protection and virus protection are described in this section. To access the sub menu for the following items, select the item and press <Enter>:

Change Administrator / User Password

Select this option and press <ENTER> to access the sub menu, and then type in the password.

Secure Boot

Secure Boot Configurations.

4.1.5 Boot

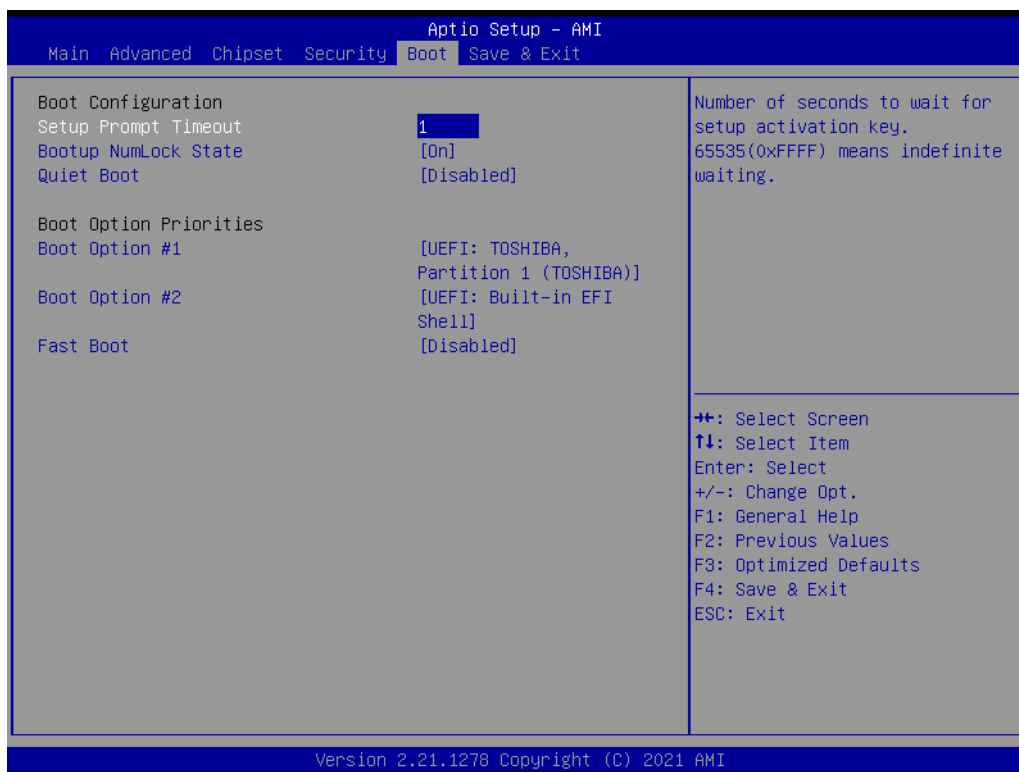

Setup Prompt Timeout

Number of seconds that the firmware will wait before initiating the original default boot selection. A value of 0 indicates that the default boot selection is to be initiated immediately on boot. A value of 65535(0xFFFF) indicates that firmware will wait for user input before booting. This means the default boot selection is not automatically started by the firmware.

Bootup NumLock State

Select the keyboard NumLock state.

Quiet Boot

Enables or disables Quiet Boot option.

Boot Option #1

Sets the system boot order.

Fast Boot

Enables or disables boot with initialization of a minimal set of devices required to launch active boot option. Has no effect for BBS boot options.

4.1.6 Save & Exit



Save Changes and Exit

This item allows you to exit system setup after saving the changes.

Discard Changes and Exit

This item allows you to exit system setup without saving any changes.

Save Changes and Reset

This item allows you to reset the system after saving the changes.

Discard Changes and Reset

This item allows you to rest system setup without saving any changes.

Save Changes

This item allows you to save changes done so far to any of the options.

Discard Changes

This item allows you to discard changes done so far to any of the options.

Restore Defaults

This item allows you to restore/load default values for all the options.

Save as User Defaults

This item allows you to save the changes done so far as user defaults.

Restore User Defaults

This item allows you to restore the user defaults to all the options.

Boot Override

Boot device select can override your boot priority.

Appendix **A**

System Assignments

This appendix contains detailed information.

Sections include:

- System I/O Ports
- DMA Channel Assignments
- 1st MB Memory Map
- Interrupt Assignments

A.1 System I/O Ports

Table A.1: System I/O Ports

Addr. Range (Hex)	Device
00h-1Fh	DMA Controller
20h-2Dh	Interrupt Controller
2Eh-2Fh	Motherboard resources
30h-3Dh	Interrupt Controller
40h-43h	Timer/Counter
4Eh-4Fh	Motherboard resources
50h-53h	Timer/Counter
60h-6Fh	8042 (keyboard controller)/NMI Controller/Microcontroller
70h-7Fh	Real-time Controller
80h-8Fh	Debug Port/Reserved
90h-9Fh	Debug Port/Reset Generator
A0h-ADh	Interrupt Controller
B0h-B1h	Interrupt Controller
B4h-BDh	Power Management
220h-227h	Communications Port (COM5)
228h-22Fh	Communications Port (COM6)
290h-29Fh	HW Monitor Index port and Data port
2E8h-2EFh	Communications Port (COM4)
2F8h-2FFh	Communications Port (COM2)
3E8h-3EFh	Communications Port (COM3)
3F8h-3FFh	Communications Port (COM1)
480h-4CFh	Motherboard Resources
4D0h-4D1h	Interrupt Controller
680h-69Fh	Motherboard Resources
A00h-AFFh	Motherboard Resources
164Eh-164Fh	Motherboard Resources
1800h-18FFh	Motherboard Resources
CF9h-CF9h	Reset Generator

A.2 DMA Channel Assignments

Table A.2: DMA Channel Assignments

Channel	Function
0	Available
1	Available
2	Available
3	Available
4	Direct Memory Access Controller
5	Available
6	Available
7	Available

A.3 1st MB Memory Map

Table A.3: 1st MB Memory Map

Addr. Range (Hex)	Device
E0000h - FFFFFh	System Board
D0000h - DFFFFh	PCI Bus
C0000h - CFFFFh	System Board
A0000h - BFFFFh	PCI Bus
A0000h - BFFFFh	Intel® HD Graphic
00000h - 9FFFFh	System Board

A.4 Interrupt Assignments

Table A.4: Interrupt Assignments

Interrupt#	Interrupt source
NMI	Parity Error Detected
IRQ0	System Timer
IRQ1	Using SERIRQ, Keyboard Emulation
IRQ2	Interrupt from Controller 2 (cascade)
IRQ3	Communications Port (COM2)
IRQ4	Communications Port (COM1)
IRQ5	Communications Port (COM3)
IRQ6	Reserved
IRQ7	Communications Port (COM4)
IRQ8	System CMOS/Real Time Clock
IRQ9	Microsoft ACPI-Compliant System
IRQ10	Communications Port (COM5)
IRQ11	Communications Port (COM6)
IRQ12	Available
IRQ13	Numeric Data Processor
IRQ14	Reserved
IRQ15	Reserved

ADVANTECH

Enabling an Intelligent Planet

www.advantech.com

Please verify specifications before quoting. This guide is intended for reference purposes only.

All product specifications are subject to change without notice.

No part of this publication may be reproduced in any form or by any means, electronic, photocopying, recording or otherwise, without prior written permission from the publisher.

All brand and product names are trademarks or registered trademarks of their respective companies.

© Advantech Co., Ltd. 2021