

**User Manual**

# UTX-3115

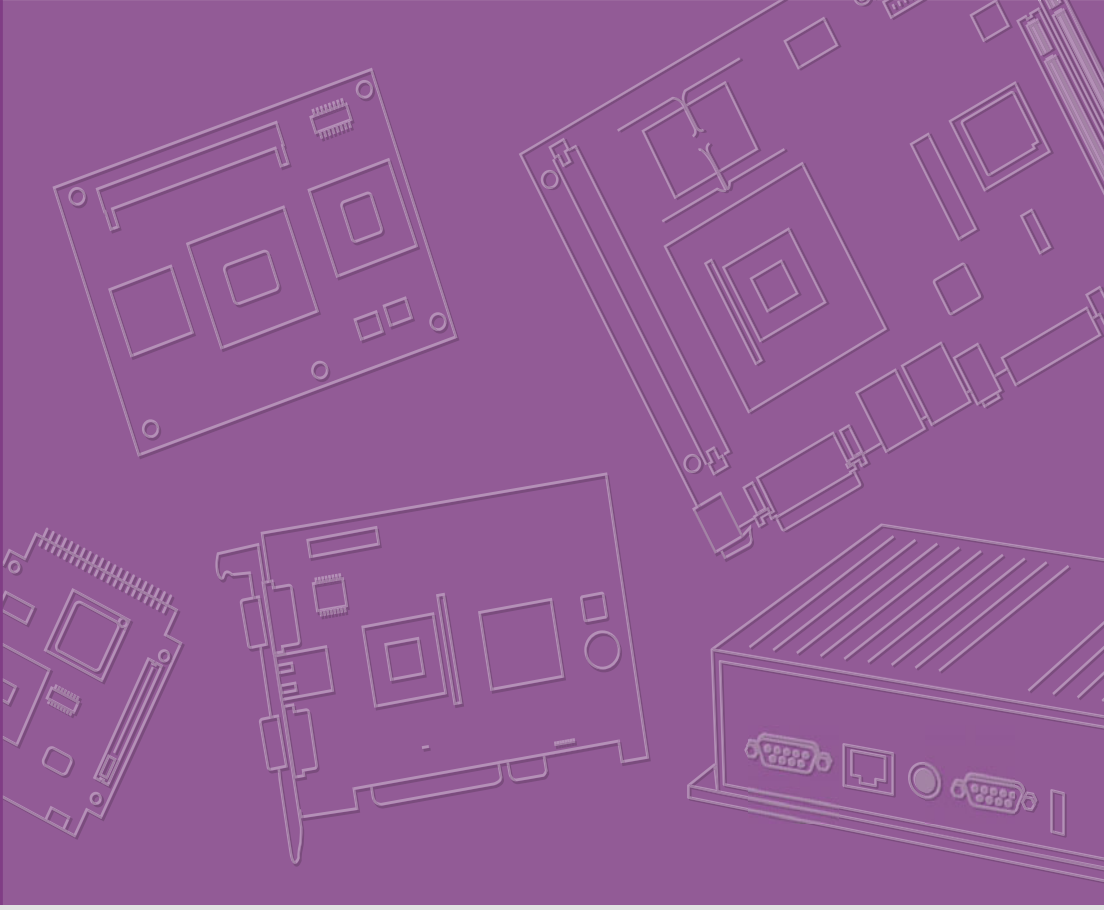

---

## Copyright

The documentation and the software included with this product are copyrighted 2015 by Advantech Co., Ltd. All rights are reserved. Advantech Co., Ltd. reserves the right to make improvements in the products described in this manual at any time without notice. No part of this manual may be reproduced, copied, translated or transmitted in any form or by any means without the prior written permission of Advantech Co., Ltd. Information provided in this manual is intended to be accurate and reliable. However, Advantech Co., Ltd. assumes no responsibility for its use, nor for any infringements of the rights of third parties, which may result from its use.

## Acknowledgements

Intel and Pentium are trademarks of Intel Corporation.

Microsoft Windows and MS-DOS are registered trademarks of Microsoft Corp.

All other product names or trademarks are properties of their respective owners.

## Declaration of Conformity

### FCC Class B

Note: This equipment has been tested and found to comply with the limits for a Class B digital device, pursuant to part 15 of the FCC Rules. These limits are designed to provide reasonable protection against harmful interference in a residential installation. This equipment generates, uses and can radiate radio frequency energy and, if not installed and used in accordance with the instructions, may cause harmful interference to radio communications. However, there is no guarantee that interference will not occur in a particular installation. If this equipment does cause harmful interference to radio or television reception, which can be determined by turning the equipment off and on, the user is encouraged to try to correct the interference by one or more of the following measures:

- Reorient or relocate the receiving antenna.
- Increase the separation between the equipment and receiver.
- Connect the equipment into an outlet on a circuit different from that to which the receiver is connected.
- Consult the dealer or an experienced radio/TV technician for help.

**Warning!** *Any changes or modifications made to the equipment which are not expressly approved by the relevant standards authority could void your authority to operate the equipment.*



**Caution!** *Danger of explosion if battery is incorrectly replaced. Replace only with the same or equivalent type recommended by the manufacturer. Dispose of used batteries according to the manufacturer's instructions.*



This device complies with Part 15 of the FCC Rules. Operation is subject to the following two conditions: (1) This device may not cause harmful interference, and (2) this device must accept any interference received, including interference that may cause undesired operation.

### FOR MOBILE DEVICE USAGE (>20cm/low power)

#### Radiation Exposure Statement:

This equipment complies with FCC radiation exposure limits set forth for an uncontrolled environment. This equipment should be installed and operated with minimum distance 20cm between the radiator & your body.

### FOR COUNTRY CODE SELECTION USAGE (WLAN DEVICES)

**Note!** *The country code selection is for non-US model only and is not available to all US model. Per FCC regulation, all WiFi product marketed in US must fixed to US operation channels only.*



This device complies with Health Canada's Safety Code. The installer of this device should ensure that RF radiation is not emitted in excess of the Health Canada's requirement. Information can be obtained at [http://www.hc-sc.gc.ca/ewh-semt/pubs/radiation/radio\\_guide-lignes\\_direct/index-eng.php](http://www.hc-sc.gc.ca/ewh-semt/pubs/radiation/radio_guide-lignes_direct/index-eng.php)

### Local Restrictions on 802.11a, 802.11b, 802.11g, and 802.11n (20, 40 MHz) Radio Usage

**Caution!** *Due to the fact that the frequencies used by WLAN (wireless local area network) may not yet be harmonized in all countries, WLAN products are designed for use only in specific countries, and are not allowed to be operated in countries other than those of designated use and approved. As a user of these products, you are responsible for ensuring that the products are used only in the countries for which they were intended and for verifying that they are configured with the correct selection of frequency and channel for the country of use. Operational restrictions for Equivalent Isotropic Radiated Power (EIRP) are provided by the system manufacturer. Any deviation from the permissible power and frequency settings for the country of use is an infringement of national law and may be punished as such. For country-specific information, see the additional compliance information supplied with the product.*



## Wireless Interoperability

The WLAN device integrated is designed to be interoperable with other WLAN products that are based on direct sequence spread spectrum (DSSS) and Orthogonal Frequency Division Multiplexing (OFDM) radio technology and to comply with the following standards:

IEEE Std. 802.11b compliant Standard on Wireless LAN

IEEE Std. 802.11g compliant Standard on Wireless LAN

IEEE Std. 802.11a compliant Standard on Wireless LAN

IEEE Std. 802.11n compliant Standard on Wireless LAN

Wireless Fidelity certification, as defined by the Wi-Fi Alliance

Operation on the 5.15-5.25GHz frequency band is restricted to indoor use only. The FCC requires indoor use for the 5.15-5.25GHz band to reduce the potential for harmful interference to co-channel Mobile Satellite Systems.

## RF Exposure Information (MPE (Maximum Permissible Exposure))

This device meets the government's requirements for exposure to radio waves. This device is designed and manufactured not to exceed the emission limits for exposure to radio frequency (RF) energy set by the Federal Communications Commission of the U.S. Government. The exposure standard for gateway devices employs a unit of measurement known as the Maximum Permissible Exposure or Power Density. The Power Density limit set by the FCC is 1 mW/cm<sup>2</sup>. The MPE evaluation is completed based on all of the radios included and is based on the output power and antenna gain of each.

The highest MPE value for this device reported to the FCC when evaluated is 721.107mW/cm<sup>2</sup>

The FCC has granted an Equipment Authorization for this device with the reported MPE levels evaluated as in compliance with the FCC RF exposure guidelines. The RF exposure information on this device is on file with the FCC and can be found under the Display Grant section of [www.fcc.gov/oet/ea/fccid](http://www.fcc.gov/oet/ea/fccid) after searching on FCC ID: **M82-UTX-3115**.

## Antenna Statement

This device has been designated to operate with the antennas listed below, and having a maximum gain of 2.98dBi at 2.4 ~ 2.5GHz and 1.4dBi at 5.15 ~ 5.85GHz. Antennas not included in this list or having a gain greater than that listed above are strictly prohibited for use with this device. The required antenna impedance is 50 ohms.

Model	Antenna Type	Manufacturer
Wireless Antenna R-AN2450-5701RS	Dipole	Invax System Technology Corp)
3G Antenna TG.09.0113	Dipole	Taoglas

The antenna(s) used for this transmitter must be installed to provide a separation distance of at least 20 cms from all persons and must not be co-located or operating in conjunction with any other antenna or transmitter. Users and installers must be provided with antenna installation instructions and transmitter operating conditions for satisfying RF exposure compliance.

## Technical Support and Assistance

1. Visit the Advantech website at <http://www.advantech.com> where you can find the latest information about the product.
2. Contact your distributor, sales representative, or Advantech's customer service center for technical support if you need additional assistance. Please have the following information ready before you call:
  - Product name and serial number
  - Description of your peripheral attachments
  - Description of your software (operating system, version, application software, etc.)
  - A complete description of the problem
  - The exact wording of any error messages

### **Warning!**



1. *Input voltage rated 12 VDC, 3 ~ 5 A (DC Mode).*
2. *Packing: please carry the unit with both hands, handle with care.*
3. *Maintenance: to properly maintain and clean the surfaces, use only approved products or clean with a dry applicator.*

## Safety Instructions

1. Read these safety instructions carefully.
2. Keep this User Manual for later reference.
3. Disconnect this equipment from any AC outlet before cleaning. Use a damp cloth. Do not use liquid or spray detergents for cleaning.
4. For plug-in equipment, the power outlet socket must be located near the equipment and must be easily accessible.
5. Keep this equipment away from humidity.
6. Put this equipment on a reliable surface during installation. Dropping it or letting it fall may cause damage.
7. The openings on the enclosure are for air convection. Protect the equipment from overheating. **DO NOT COVER THE OPENINGS.**
8. Make sure the voltage of the power source is correct before connecting the equipment to the power outlet.
9. Position the power cord so that people cannot step on it. Do not place anything over the power cord.
10. All cautions and warnings on the equipment should be noted.
11. If the equipment is not used for a long time, disconnect it from the power source to avoid damage by transient overvoltage.
12. Never pour any liquid into an opening. This may cause fire or electrical shock.
13. Never open the equipment. For safety reasons, the equipment should be opened only by qualified service personnel.
14. If one of the following situations arises, get the equipment checked by service personnel:
  - a. The power cord or plug is damaged.
  - b. Liquid has penetrated into the equipment.
  - c. The equipment has been exposed to moisture.
  - d. The equipment does not work well, or you cannot get it to work according to the user's manual.
  - e. The equipment has been dropped and damaged.
  - f. The equipment has obvious signs of breakage.

- 
15. DO NOT LEAVE THIS EQUIPMENT IN AN ENVIRONMENT WHERE THE STORAGE TEMPERATURE MAY GO BELOW -20° C (-4° F) OR ABOVE 60° C (140° F). THIS COULD DAMAGE THE EQUIPMENT. THE EQUIPMENT SHOULD BE IN A CONTROLLED ENVIRONMENT.
  16. If your computer is losing dramatic time or the BIOS configuration reset to default, the battery has no power.

**Caution!** 1. *Do not replace power adaptor yourself. Please contact a qualified technician or your retail.*



2. *The computer is provided with a battery-powered real-time clock circuit. There is a danger of explosion if battery is incorrectly replaced. Replace only with same or equivalent type recommended by the manufacture. Discard used batteries according to the manufacturer's instructions.*

17. CLASSIFICATION:
  - Supply by Class I adapter
  - No applied part
  - Continuous Operation
  - Not AP or APG category
18. Follow the national requirement to dispose unit.
19. Maintenance: to properly maintain and clean the surfaces, use only the approved products or clean with a dry cloth.
20. Contact information:  
No.1, Alley 20, Lane 26, Rueiguang Road Neihu District, Taipei, Taiwan 114,  
R.O.C  
TEL: (02)27927818
21. Canadian Emissions Statement: CAN ICES-3 (B)/NMB-3(B)  
Cet appareil numérique de la classe B est conforme à la norme NMB-003 du Canada.

## Industry Canada Statement

This device complies with RSS-210 of the Industry Canada Rules. Operation is subject to the following two conditions: (1) This device may not cause harmful interference, and (2) this device must accept any interference received, including interference that may cause undesired operation.

Ce dispositif est conforme à la norme CNR-210 d'Industrie Canada applicable aux appareils radio exempts de licence. Son fonctionnement est sujet aux deux conditions suivantes: (1) le dispositif ne doit pas produire de brouillage préjudiciable, et (2) ce dispositif doit accepter tout brouillage reçu, y compris un brouillage susceptible de provoquer un fonctionnement indésirable.

Ce dispositif a été désigné pour fonctionner avec les antennes énumérées ci-dessous, et ayant un gain maximal de 2.98dBi @ 2.4 ~ 2.5GHz 1.4dBi @ 5.15 ~ 5.85GHz. Antennes pas inclus dans cette liste ou présentant un gain supérieur à 2.98dBi @ 2.4 ~ 2.5GHz & 1.4dBi @ 5.15 ~ 5.85GHz sont strictement interdits pour une utilisation avec cet appareil. L'impédance d'antenne requise est 50 ohms. "

Modèle	Antenna Type	Manufacturer
Wireless Antenna R-AN2450-5701RS	Dipole	Invax System Technology Corp)
3G Antenna TG.09.0113	Dipole	Taoglas

### Caution :

- (i) the device for operation in the band 5150-5250 MHz is only for indoor use to reduce the potential for harmful interference to co-channel mobile satellite systems;
- (ii) the maximum antenna gain permitted for devices in the bands 5250-5350 MHz and 5470-5725 MHz shall comply with the e.i.r.p. limit; and
- (iii) the maximum antenna gain permitted for devices in the band 5725-5825 MHz shall comply with the e.i.r.p. limits specified for point-to-point and non point-to-point operation as appropriate.
- (iv) Users should also be advised that high-power radars are allocated as primary users (i.e. priority users) of the bands 5250-5350 MHz and 5650-5850 MHz and that these radars could cause interference and/or damage to LE-LAN devices.

### Avertissement:

Le guide d'utilisation des dispositifs pour réseaux locaux doit inclure des instructions précises sur les restrictions susmentionnées, notamment :

- (i) les dispositifs fonctionnant dans la bande 5 150-5 250 MHz sont réservés uniquement pour une utilisation à l'intérieur afin de réduire les risques de brouillage préjudiciable aux systèmes de satellites mobiles utilisant les mêmes canaux;
- (ii) le gain maximal d'antenne permis pour les dispositifs utilisant les bandes 5 250-5 350 MHz et 5 470-5 725 MHz doit se conformer à la limite de p.i.r.e.;
- (iii) le gain maximal d'antenne permis (pour les dispositifs utilisant la bande 5 725-5 825 MHz) doit se conformer à la limite de p.i.r.e. spécifiée pour l'exploitation point à point et non point à point, selon le cas.
- (iv) De plus, les utilisateurs devraient aussi être avisés que les utilisateurs de radars de haute puissance sont désignés utilisateurs principaux (c.-à-d., qu'ils ont la priorité) pour les bandes 5 250-5 350 MHz et 5 650-5 850 MHz et que ces radars pourraient causer du brouillage et/ou des dommages aux dispositifs LAN-EL.

---

## FOR MOBILE DEVICE USAGE (>20cm/low power)

### **Radiation Exposure Statement:**

This equipment complies with IC radiation exposure limits set forth for an uncontrolled environment. This equipment should be installed and operated with minimum distance 20cm between the radiator & your body.

### **Déclaration d'exposition aux radiations:**

Cet équipement est conforme aux limites d'exposition aux rayonnements IC établies pour un environnement non contrôlé. Cet équipement doit être installé et utilisé avec un minimum de 20 cm de distance entre la source de rayonnement et votre corps.

## French User Manual Statements for RSS Warnings

### **FCC/Industry Canada Two Part Stmt:**

#### **English Version**

This device complies with FCC Part 15 and Industry Canada license exempt RSS standard(s). Operation is subject to the following two conditions: (1) this device may not cause interference, and (2) this device must accept any interference, including interference that may cause undesired operation of the device.

#### **French Version**

Cet appareil est conforme à FCC Partie15 d'Industrie Canada RSS standard exempts de licence (s). Son utilisation est soumise à Les deux conditions suivantes: (1) cet appareil ne peut pas provoquer d'interférences et (2) cet appareil doit accepter Toute interférence, y compris les interférences qui peuvent causer un mauvais fonctionnement du dispositif.

### **Per Industry Canada RSS rules:**

#### **English version**

This device complies with Health Canada's Safety Code. The installer of this device should ensure that RF radiation is not emitted in excess of the Health Canada's requirement. Information can be obtained at [http://www.hc-sc.gc.ca/ewh-sem/pubs/radiation/radio\\_guide-lignes\\_direct-eng.php](http://www.hc-sc.gc.ca/ewh-sem/pubs/radiation/radio_guide-lignes_direct-eng.php)

#### **French version**

Cet appareil est conforme avec Santé Canada Code de sécurité 6. Le programme d'installation de cet appareil doit s'assurer que les rayonnements RF n'est pas émis au-delà de l'exigence de Santé Canada. Les informations peuvent être obtenues: [http://www.hc-sc.gc.ca/ewhsemt/pubs/radiation/radio\\_guide-lignes\\_direct-eng.php](http://www.hc-sc.gc.ca/ewhsemt/pubs/radiation/radio_guide-lignes_direct-eng.php)

#### **English Version**

"Changes or modifications not expressly approved by the party responsible for compliance could void the user's authority to operate the equipment."

#### **French Version**

"Les changements ou modifications non expressément approuvés par la partie responsable de la conformité pourraient annuler l'autorité de l'utilisateur à utiliser cet équipement."



# European Union Declaration of Conformity Statement

We, Advantech, declare under our sole responsibility that the product, model, is in conformity with all applicable essential requirements Necessary for CE marking, following the provisions of the European Council Directives 2004/108/EC (EMC Directive), 2006/95/EC (Low Voltage Directive), 1999/5/EC (Radio and Telecommunications Terminal Equipment Directive) and 2011/65/EU (ROHS Directive).

The product is properly CE marked demonstrating this conformity and is for distribution within all member states of the EU with no restrictions.

This product follows the provisions of the European Directives 2004/108/EC, 2006/95/EC, 1999/5/EC and 2011/65/EU.

**Čeština** Tento výrobek odpovídá požadavkům evropských směrnic 2004/108/EC, 2006/95/EC, 1999/5/EC a 2011/65/EU.

**Dansk** Dette produkt er i overensstemmelse med det europæiske direktiv 2004/108/EC, 1999/5/EC, 2006/95/EC & 2011/65/EU.

**Dutch** Dit product is in navolging van de bepalingen van Europees Directief 2004/108/EC, 1999/5/EC, 2006/95/EC & 2011/65/EU.

**Eesti** Antud toode vastab Euroopa direktiivides 2004/108/EC, ja 2006/95/EC ja 1999/5/EC ja 2011/65/EU kehtestatud nõuetele.

**Suomi** Tämä tuote noudattaa EU-direktiivin 2004/108/EC, 1999/5/EC, 2006/95/EC & 2011/65/EU määräyksiä.

**Français** Ce produit est conforme aux exigences de la Directive Européenne 2004/108/EC, 1999/5/EC, 2006/95/EC & 2011/65/EU.

**Deutsch** Dieses Produkt entspricht den Bestimmungen der Europäischen Richtlinie 2004/108/EC, 1999/5/EC 2006/95/EC & 2011/65/EU.

**Ελληνικά** Το παρόν προϊόν ακολουθεί τις διατάξεις των Ευρωπαϊκών Οδηγιών 2004/108/EC, 1999/5/EC, 2006/95/EC και 2011/65/EU.

**Magyar** E termék megfelel a 2004/108/EC, 1999/5/EC, 2006/95/EC és 2011/65/EU Európai Irányelv előírásainak.

**Icelandic** Þessi vara stenst reglugerð Evrópska Efnahags Bandalagsins númer 2004/108/EC, 2006/95/EC, & 2011/65/EU.

**Italiano** Questo prodotto è conforme alla Direttiva Europea 2004/108/EC, 1999/5/EC, 2006/95/EC & 2011/65/EU.

**Latviešu** Šis produkts atbilst Eiropas Direktīvu 2004/108/EC, 1999/5/EC, 2006/95/EC un 2011/65/EU noteikumiem.

**Lietuvi** ū Šis produktas atitinka Europos direktyvų 2004/108/EC, 1999/5/EC, 2006/95/EC, ir 2011/65/EU nuostatas.

**Malti** Dan il-prodott hu konformi mal-provvedimenti tad-Direttivi Ewropej 2004/108/EC, 1999/5/EC, 2006/95/EC u 2011/65/EU.

**Norsk** Dette produktet er i henhold til bestemmelsene i det europeiske direktivet 2004/108/EC, 1999/5/EC, 2006/95/EC & 2011/65/EU.

**Polski** Niniejszy produkt jest zgodny z postanowieniami Dyrektyw Unii Europejskiej 2004/108/EC, 1999/5/EC, 2006/95/EC i 2011/65/EU.

**Portuguese** Este produto cumpre com as normas da Diretiva Europeia 2004/108/EC, 1999/5/EC, 2006/95/EC & 2011/65/EU.

**Español** Este producto cumple con las normas del Directivo Europeo 2004/108/EC, 1999/5/EC, 2006/95/EC & 2011/65/EU.

**Slovensky** Tento produkt je v súlade s ustanoveniami európskych direktív 2004/108/EC, 1999/5/EC, 2006/95/EC a 2011/65/EU.

**Slovenščina** Izdelek je skladen z določbami evropskih direktiv 2004/108/EC, 1999/5/EC, 2006/95/EC in 2011/65/EU.

**Svenska** Denna produkt har tillverkats i enlighet med EG-direktiv 2004/108/EC, 1999/5/EC 2006/95/EC & 2011/65/EU.

**Türkçe** Bu ürün, Avrupa Birliği'nin 2004/108/EC, 1999/5/EC, 2006/95/EC ve 2011/65/EU yönergelerine uyar.

**European Union:**

The low band 5.15 -5.35 GHz is for indoor use only.



■ This symbol on the product indicates compliance with Directive 2002/96/EC (WEEE). Do not dispose of product in unsorted municipal waste.

Please recycle this product in a responsible manner. Refer to local environmental regulations for proper recycling; do not dispose of product in unsorted municipal waste.

## Packing List

Before installation, please ensure the following items have been shipped:

- 1 x UTX-3115 unit
- 1 x DC 12 V 36W power adaptor
- 1 x China RoHS
- 1 x Warranty card
- 1 x Chinese user manual

## Ordering Information

P/N	Description	CPU	CRT/ HDMI/ uHDMI	G.LAN	COM	SATAII	USB3.0/2.0	Antenna	Antenna Post	WindRiver IDP2.X
UTX-3115B-S6A2E	Barebone	E3826	1/1/1	2	1	1	1/2	0	2 +2*	No (w/o OS)
UTX-3115SA4-S6A2E	System w/4 antenna,2G RAM & 32G SSD	E3826	1/1/1	2	1	1	1/2	4	2 +2*	No (w/o OS)
UTX-3115SA4P-S6A2E	System w/4 antenna,2G RAM, 32G SSD, IDP	E3826	1/1/1	2	1	1	1/2	4	2 +2*	Yes
UTX-3115SA4L-S6A1E	System w/4 antenna, 2G RAM & 32G SSD	E3815	1/1/1	2	1	1	1/2	4	2 +2*	No (w/o OS)
UTX-3115FS-S6A2E	Emb.sys. UTX-3115.2G RAM.SSD.AC7260 module. E910G module.4Antenna.	E3826	1/1/1	2	1	1	1/2	4	2+2*	Yes

# Compatibility List

## Power Cord

Part Number	Description
1700001524	Power Cable 3-pin 180cm, USA type (For power adapter 1757004096-01)
170203183C	Power Cable 3-pin 180cm, Europe type (For power adapter 1757004096-01)
170203180A	Power Cable 3-pin 180cm, UK type (For power adapter 1757004096-01)
1700008921	Power Cable 3-pin PSE Mark 183cm (For power adapter 1757004096-01)
1702002600-01	Power cable 3-pin 183 cm, USA type (For power adapter 1757004522-01)
1700018705	Power cable 3-pin 183 cm, Europe type (For power adapter 1757004522-01)
1700018704	Power cable 3-pin 183 cm, UK type (For power adapter 1757004522-01)
1700000237-01	Power cable 3-pin 183 cm, PSE type (For power adapter 1757004522-01)

## Mounting Bracket

Part Number	Description
AIMB-0BRK-VM01E	UTX-3115 VESA Mount bracket kit
AIMB-0BRK-WM01E	UTX-3115 Wallmount bracket kit
AIMB-0BRK-DR01E	UTX-3115 DIN rail bracket kit

## Memory

Test Item	Description							Result	Remark
Brand	Size	Speed	Type	ECC	Vendor PN	Memory	Advantech PN		
Transcend	2GB	DDR3 1333	SODIMM DDR3	N	TS256MSK 64W3N	SEC 234 HYK0 K4B2G0846D		PASS	
Apacer	4GB	DDR3 1333	SODIMM DDR3	N	78.B2GCV. AT00C	MICRON 2XE22 D9QBJ	96SD3L-4G1333NN-AP	PASS	
DSL	8GB	DDR3 1333	SODIMM DDR3	N	D3SE1208 XL15AB	ELPIDA J4208EBBG-GN-F		PASS	
Apacer	8GB	DDR3 1333	SODIMM DDR3	N	78.C2GCV. AT30C	2XE22 D9QBJ		PASS	
Apacer	2GB	DDR3 1600	SODIMM DDR3	N	78.A2GCR. AT00C	MICRON IYM22 D9PFJ (256x8)		PASS	
Apacer	4GB	DDR3 1600	SODIMM DDR3	N	78.B2GCR. AF10C	HYNIX H5TC2G83EFR		PASS	
Apacer	4GB	DDR3 1600	SODIMM DDR3	N	78.B2GCZ. AT00C	MICRON 2QE22 D9QBJ		PASS	
Transcend	4GB	DDR3 1600	SODIMM DDR3	N	TS512MSK 64W6H	SEC 231 HYK0 K4B4G0846B	96SD3L-4G1600NN-TR	PASS	
AQD	4GB	DDR3 1600	SODIMM DDR3	N	653555-0007	SEC 316 XYK0 K4B4G0846B	AQD-SD3L4GN1 6-SG	PASS	
Apacer	8GB	DDR3 1600	SODIMM DDR3	N	78.C2GCZ. AT30C	MICRON 2REI7 D9QBJ		PASS	
Transcend	8GB	DDR3 1600	SODIMM DDR3	N	TS1GSK64 W6H	SEC 231 HYK0 K4B4G0846B	96SD3L-8G1600NN-TR	PASS	
DSL	8GB	DDR3 1600	SODIMM DDR3	N	D3SE1208 XL12AA	ELPIDA J4208EBBG-GN-F		PASS	
ATP	8GB	DDR3 1600	SODIMM DDR3	N	AW24P64F 8BLKOM	MICRON 2YE77 D9QBJ		PASS	
AQD	8GB	DDR3 1600	SODIMM DDR3	N	653559-0021	SEC 316 XYK0 K4B4G0846B	AQD-SD3L8GN1 6-SG	PASS	
AQD	8GB	DDR3 1600	SODIMM DDR3	N	6657223-0463	SEC 401 HYK0 K484GO846B	AQD-SD3L8GN1 6-SG	PASS	
AQD	8GB	DDR3 1600	SODIMM DDR3	N	TS9KRH30 800	MICRON 2UD27 D9PCP	AQD-SD3L8GN1 6-MG	PASS	
AQD	2GB	DDR3 1600	SODIMM DDR3	N	665205-0397	SEC 310 XYK0 K4B2G084GD	AQD-SD3L2GN1 6-SQ	PASS	
AQD	2GB	DDR3 1600	SODIMM DDR3	N	201403504 691	HYNIX H5TC2G83EFR	AQD-SD3L2GN1 6-HQ	PASS	
AQD	4GB	DDR3 1600	SODIMM DDR3	N	665723-0556	SEC 401 XYK0 K4B4G0846B	AQD-SD3L4GN1 6-SG	PASS	
AQD	8GB	DDR3 1600	SODIMM DDR3	N	665765-0002	SEC 343 XYK0 K4B4G0846D	AQD-SD3L8GN1 6-SG	PASS	

## WiFi and 3G module

Test Item			Description		Result	Remark
Type	Brand Name	Model	Interface	Advantech P/N		
802.11 a/b/g/n, Atheros AR9382, 2T2R	Unex	DNXA-116	Half Mini PCIe Card	968EMW0062	PASS	
802.11 a/b/g/n, Intel Taylor Peak, 2T2R	Intel	62205AN.H MWEB	Mini-PCIe	968EMW0067	PASS	
WIFI 802.11bgn (half size)	Advantech	RT5390 1T1R	Mini-PCIe(USB signal)	EWM-W150H01E	PASS	
WIFI 802.11bgn 1-connector (half size)	Advantech	RTL8188EE 1T1R	Mini-PCIe	EWM-W151H01E	PASS	
WIFI 802.11BGN +Bluetooth4.0 Module	Advantech	6002B44C65 4D	Mini-PCIe	EWM-W153H101E	PASS	

# Contents

<b>Chapter 1</b>	<b>Introduction.....</b>	<b>1</b>
1.1	Overview .....	2
1.2	System Configuration.....	3
1.3	General Specifications .....	4
1.3.1	Standard PC Functions.....	4
1.3.2	Power Environmental.....	4
1.4	Mechanical Specifications.....	4
1.4.1	Mechanical Specifications (Terminal) .....	4
1.5	Environmental Specifications.....	5
<b>Chapter 2</b>	<b>Jumper and Connector list .....</b>	<b>7</b>
2.1	Jumpers .....	8
2.1.1	Jumper Description .....	8
2.1.2	Jumper Settings .....	8
	Table 2.1: AT/ATX Mode Selection (PSON1).....	8
2.2	Connectors.....	9
2.2.1	Audio1: Audio Line Out w/ Jack Detection.....	9
	Table 2.2: Audio Connector Pin Assignments .....	9
2.2.2	BAT1: Battery Connector .....	9
	Table 2.3: Battery Connector Pin Assignments .....	9
2.2.3	COM1: COM Port w/ RS-232 Feature .....	10
	Table 2.4: COM Port Pin Assignments .....	10
2.2.4	COM2: COM Port w/ RS-422/485 Feature .....	10
	Table 2.5: COM Port Pin Assignments .....	10
2.2.5	SATALED1: SATA Active LED Connector.....	11
	Table 2.6: SATA LED Connector Pin Assignments.....	11
2.2.6	SATAPWR1: SATA Power Connector .....	11
	Table 2.7: SATA Power Connector Pin Assignments.....	11
2.2.7	VGA1: D-SUB 9 pin connector from Pin Header .....	12
	Table 2.8: D-SUB Connector Pin Assignments .....	12
2.2.8	LAN: RJ45 connector.....	12
	Table 2.9: LAN Port Pin Assignments .....	12
2.2.9	HDD LED Indicator .....	13
2.2.10	Power ON/OFF Button.....	13
2.2.11	HDMI Connector .....	13
	Table 2.10: HDMI Connector Pin Assignments .....	13
<b>Chapter 3</b>	<b>Peripherals Installation .....</b>	<b>15</b>
3.1	HDD Installation .....	16
3.2	Mini PCIe Module Installation.....	18
<b>Chapter 4</b>	<b>BIOS Setup.....</b>	<b>21</b>
4.1	Introduction .....	22
4.2	Entering Setup .....	23
4.2.1	Main Menu .....	23
4.2.2	Advanced BIOS Features .....	24
4.2.3	Chipset.....	35
4.2.4	Security .....	44
4.2.5	Boot.....	46

---

4.2.6	Save & Exit .....	47
-------	-------------------	----



# Chapter 1

## Introduction

This Chapter briefly introduces the UTX-3115 product.

---

## 1.1 Overview

Advantech UTX-3115 system is a refreshingly new idea. Essentially what Advantech have created is an ultra compact PC standard that we want to be the future of computing. Advantech UTX-3115 is an intelligent and impressive small device for small spaces or anywhere else you can imagine. Since low power and small Intel CPUs have come quite a long way, UTX-3115 is designed with the latest Intel SOC which has lower power consumption but with higher CPU performance. The benefit for customer in UTX-3115 is quiet operation and wide temperature system and is open to a large range of applications and markets. UTX-3115 target market is generated in the digital signage, media-centre PCs, as well as all-in-ones, and Intelligent vending machine. At present the mini-pc market has boomed with ARM-powered Android based machines. If you are a windows user, then it's good news for you because UTX-115 small system is based on the shelf Intel components and is capable of running Linux or Windows.

### Benefits:

- Ultra Thin ITX embedded system with CE/FCC certification
- Fanless, Wide-temperature with high performance and flexibility
- Independent displays supported (HDMI, micro HDMI, LVDS)
- One-Stop Integrated Solution: Integrated ultra compact motherboard, chassis, peripherals and software
- Dimensions: 116 x 141 x 35 mm (4.6 x 5.5 x 1.4 in")

## 1.2 System Configuration

The following diagram is a block drawing of the UTX-3115.

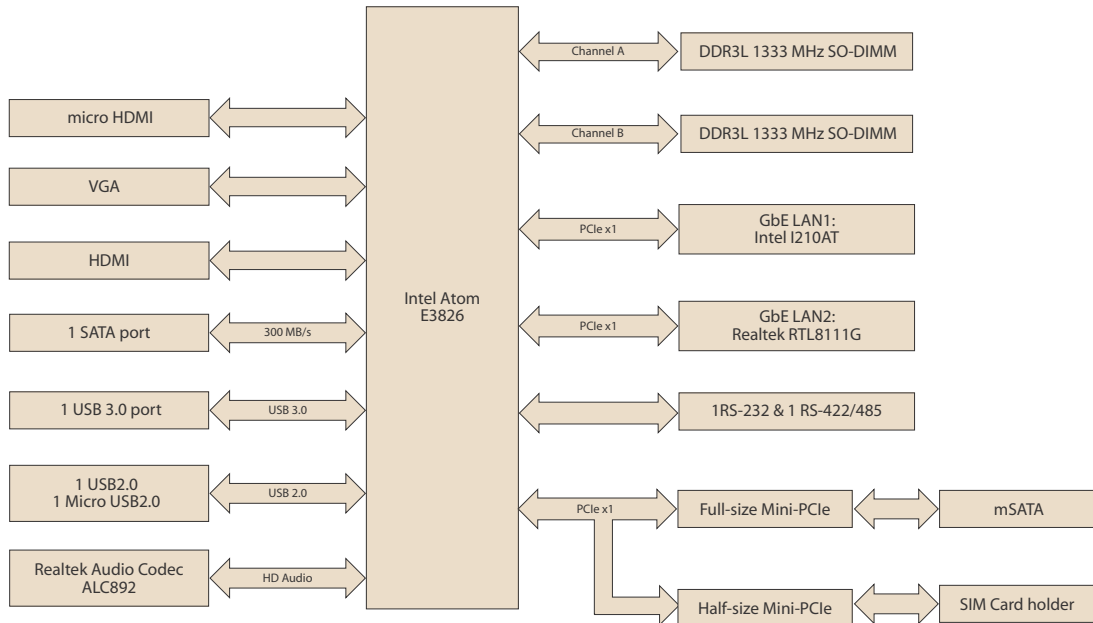

### Button I/O arrangement:

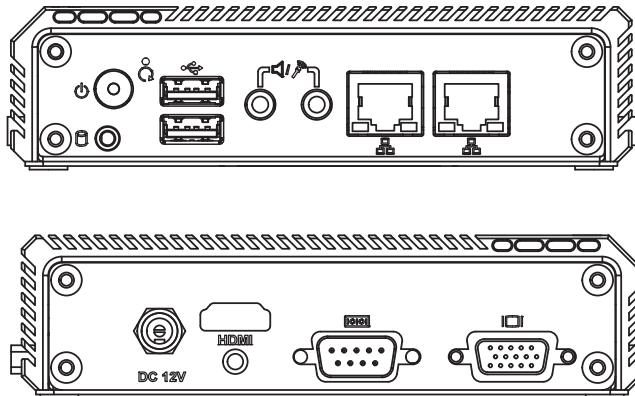

## 1.3 General Specifications

### 1.3.1 Standard PC Functions

- **CPU:** Intel ATOM e3826 1.46GHz
- **BIOS:** AMI EFI 16bit
- **Memory:** DDR3L SODIMM 1066/1333MHz up to 8GB
- **Audio:** HD audio codec ALC892
- **LAN:** PCI-E gIGABIT Ethernet controllers x2  
LAN1: Intel i210AT; LAN2: RTL8111G
- **Universal serial bus (USB) port:** 1 USB3.0/1 USB2.0/ 1 Micro USB2.0, 3 ports for external I/O
- **Mini PCI-E bus expansion slot:** 1 F/S miniPCIE support mSATA/3G card; 1 H/S miniPCIE support WIFI card
- **Storage housing:** 1 2.5" slim SSD
- **Audio:** Mic-in, Line-out
- **LAN:** Gigabit LAN x 2

### 1.3.2 Power Environmental

- **Power adaptor:** AC/DC
  - Input voltage: 100 Vac ~ 240 Vac @ 50 - 60 Hz, 1.5 A
  - Output voltage: 12 V @ 3 A

## 1.4 Mechanical Specifications

### 1.4.1 Mechanical Specifications (Terminal)

- **System Dimensions:** 138.5 x 35.98 x 116.4 mm (5.5" x 1.4" x 4.6")

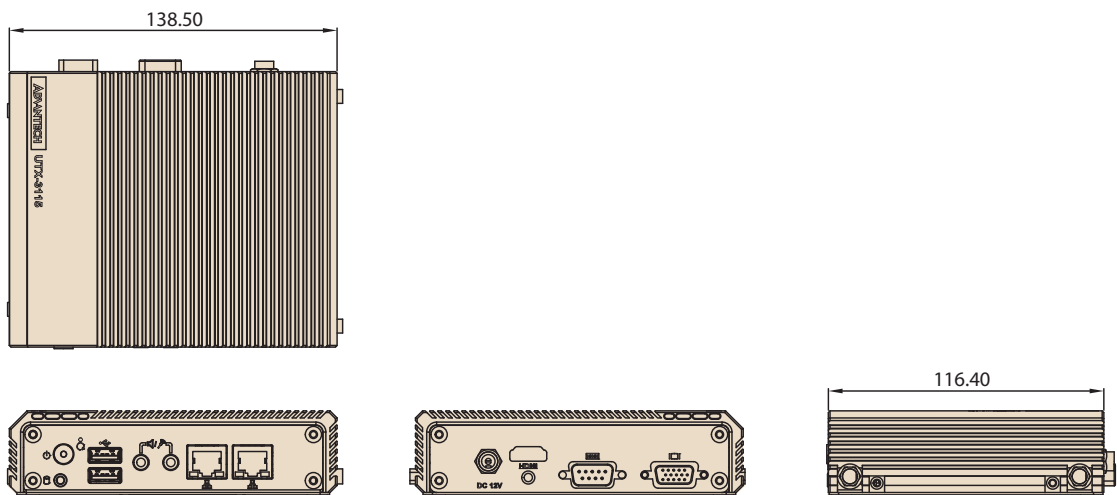

- **Carton Dimensions:** 255 (L) X 235 (W) X 160 (H) mm
- **Gross Weight:** 2.0 kg
- **Net Weight:** 1.8 kg

## 1.5 Environmental Specifications

### Temperature & Humidity

- **Operating Temperature:** -20 ~ 60° C
- **Storage Temperature:** -40 ~ 60° C
- **Relative Humidity:** 40 ~ 95% RH (Non-condensed)

### Safety

- CE / UL/CB/CCC/BSMI

### EMI

- FCC class B approved for USA, Canada, and EU

### Vibration:

- With SSD: 3Grms, 60068-2-64, random, 5 ~ 500 Hz, 1 hr/axis



# Chapter 2

Jumper and  
Connector list

## 2.1 Jumpers

### 2.1.1 Jumper Description

Cards can be configured by setting jumpers. A jumper is a metal bridge used to close an electric circuit. It consists of two metal pins and a small metal clip (often protected by a plastic cover) that slides over the pins to connect them. To close a jumper, you connect the pins with the clip. To open a jumper, you remove the clip. Sometimes a jumper will have three pins, labeled 1, 2 and 3. In this case you would connect either pins 1 and 2, or 2 and 3.

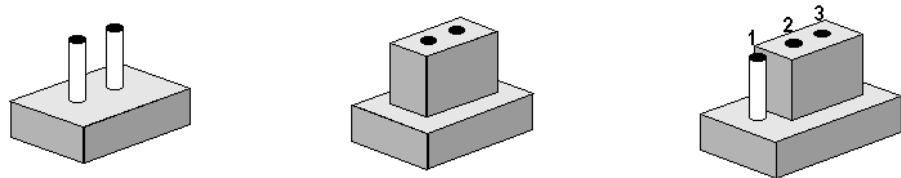

The jumper settings are schematically depicted in this manual as follows.

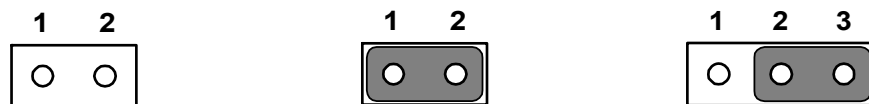

A pair of needle-nose pliers may be helpful when working with jumpers. If you have any doubts about the best hardware configuration for your application, contact your local distributor or sales representative before you make any changes.

Generally, you simply need a standard cable to make most connections.

### 2.1.2 Jumper Settings

**Warning!** To avoid damaging the computer, always turn off the power supply before setting jumpers or clearing CMOS. Before turning on the power supply, make sure CMOS jumper is back to 3.0 V Battery On.



**Table 2.1: AT/ATX Mode Selection (PSON1)**

Function	Setting
AT Mode (Default)	
ATX Mode	



## 2.2 Connectors

### 2.2.1 Audio1: Audio Line Out w/ Jack Detection

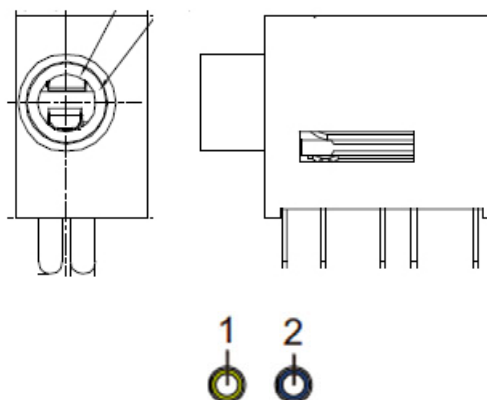

**Table 2.2: Audio Connector Pin Assignments**

Pin	Signal Name
1	Line-out
2	Line-in

### 2.2.2 BAT1: Battery Connector

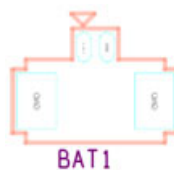

**Table 2.3: Battery Connector Pin Assignments**

Pin Number	Description	Pin Number	Description
1	Battery +	2	Battery -

### 2.2.3 COM1: COM Port w/ RS-232 Feature

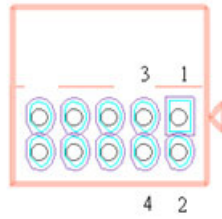

**Table 2.4: COM Port Pin Assignments**

Pin Number	Description	Pin Number	Description
1	Not Connected	2	Not Connected
3	RXD	4	RTS
5	TXD	6	CTS
7	Not Connected	8	Optional 5V/12V Power
9	Ground	10	Not Connected

### 2.2.4 COM2: COM Port w/ RS-422/485 Feature

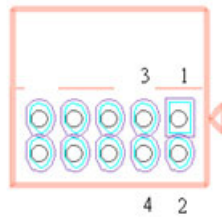

**Table 2.5: COM Port Pin Assignments**

Pin Number	Description	Pin Number	Description
1	Ground	2	CTS-
3	CTS+	4	RTS-
5	RTS+	6	TXD+
7	RXD+	8	TXD-
9	RXD-	10	Not Connected

## 2.2.5 SATALED1: SATA Active LED Connector

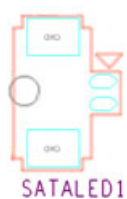

**Table 2.6: SATA LED Connector Pin Assignments**

Pin Number	Description	Pin Number	Description
1	LED +	2	LED -

## 2.2.6 SATAPWR1: SATA Power Connector

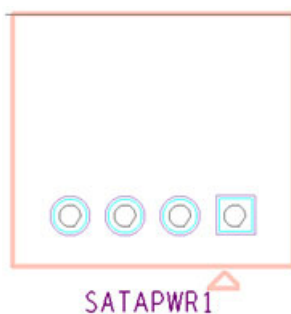

**Table 2.7: SATA Power Connector Pin Assignments**

Pin Number	Description	Pin Number	Description
1	5V	2	Ground
3	Ground	4	12V

## 2.2.7 VGA1: D-SUB 9 pin connector from Pin Header

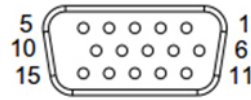
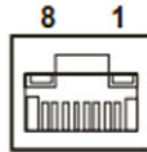

**Table 2.8: D-SUB Connector Pin Assignments**

Pin Number	Description	Pin Number	Description
1	Red	2	DDC Clock
3	Green	4	Ground
5	Blue	6	DDC Data
7	V Sync	8	Ground
9	H Sync		

## 2.2.8 LAN: RJ45 connector.

UTX-3115 provides two RJ45 LAN interface connector which is fully compliant with IEEE 802.3u 10/100/1000 Mbps CSMA/CD standards. It is equipped with Intel I210 and Realtek 8111G support Wake on LAN. The Ethernet port uses a standard RJ-45 jack connector with LED indicators on the front side to show Active/Link status and Speed status.



**Table 2.9: LAN Port Pin Assignments**

Pin	10/100/1000 Mbps Signal Name
1	TX+, MDI0+
2	TX-, MDI0-
3	RX+, MDI1+
4	MDI2+
5	MDI2-
6	RX-, MDI1-
7	MDI3+
8	MDI3-

**Note!** NC, if present, means “No Connection”.



## 2.2.9 HDD LED Indicator

HDD LED indicator on UTX-3115 front metal face plate for indicating system status: HDD LED is for HDD flash disk status.



## 2.2.10 Power ON/OFF Button

UTX-3115 comes with a Power On/Off button with LED indicators on the front side to show its On status (white LED) and Off.



## 2.2.11 HDMI Connector

UTX-3115 provided two HDMI connectors. The HDMI link supports resolutions up to 1920 x 1080 @ 60 Hz.

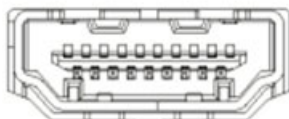

**Table 2.10: HDMI Connector Pin Assignments**

Pin Number	Description	Pin Number	Description
1	TMDS_Data2+/DP_Data0+	2	GND
3	TMDS_Data2-/DP_Data0-	4	TMDS_Data1+/DP_Data1+
5	GND	6	TMDS_Data1-/DP_Data1-
7	TMDS_Data0+/DP_Data2+	8	GND
9	TMDS_Data0-/DP_Data2-	10	TMDS_Clock+/DP_Data3+
11	GND	12	TMDS_Clock-/DP_Data3-
13	NC	14	NC
15	SCL/AUX_CH+	16	SDA/GND
17	DDC GND/AUX_CH-	18	+5V/Hot plug detect
19	Hot plug detect return	20	DP_PWR

**Note!** *HDMI does not support hot plug function due to Intel's constraint.*





# Chapter 3

Peripherals  
Installation

## 3.1 HDD Installation

1. Unscrew the bottom cover screws.



2. Secure 2.5" SATA HDD onto the bottom cover. The screws are in the accessory box.

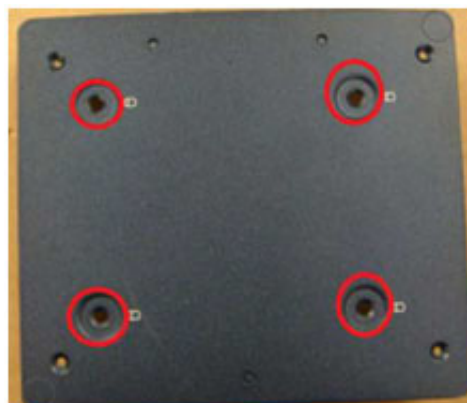



3. Connect SATA signal and power cable to the 2.5" SATA HDD.



4. Secure the bottom cover in its original position.

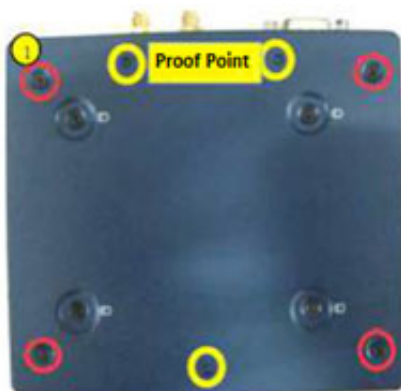

## 3.2 Mini PCIe Module Installation

1. Unscrew the bottom cover screws.



2. Insert Mini PCIe module into the slot and secure the screw to fix the mSATA storage.

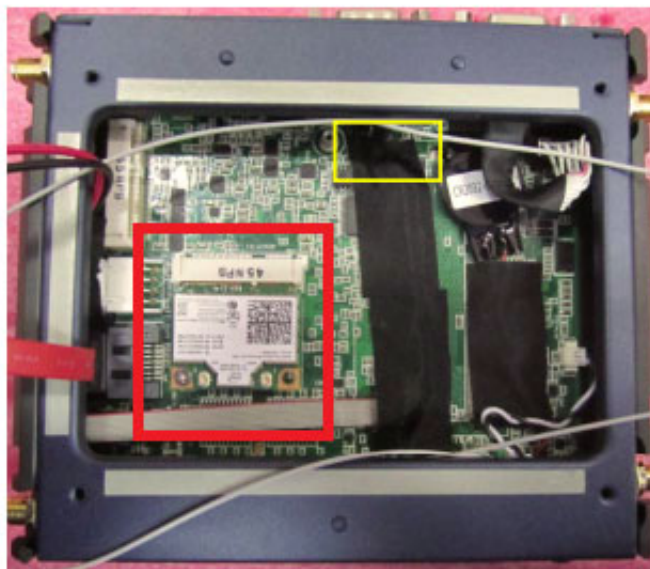

3. Connect the antenna cable to module.



4. Secure the bottom cover in its original position.

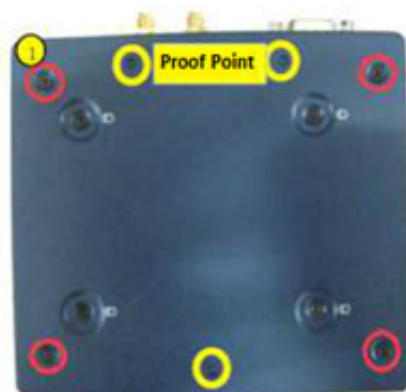



# Chapter 4

BIOS Setup

---

## 4.1 Introduction

AMI BIOS has been integrated into many motherboards for over a decade. With the AMI BIOS Setup program, users can modify BIOS settings and control various system features. This chapter describes the basic navigation of the UTX-3115 BIOS setup screens.

AMI's BIOS ROM has a built-in Setup program that allows users to modify the basic system configuration. This information is stored in flash ROM so it retains the Setup information when the power is turned off.

**Note!** *Default BIOS is supported for 32-bit OS installation, BIOS for 64-bit OS is supported by project, please contact with sales representative for details.*



## 4.2 Entering Setup

### 4.2.1 Main Menu

Press <Del> to enter AMI BIOS CMOS Setup Utility, the Main Menu will appear on the screen. Use arrow keys to select among the items and press <Enter> to accept or enter the sub-menu.



The Main BIOS setup screen has two main frames. The left frame displays all the options that can be configured. Grayed-out options cannot be configured; options in blue can. The right frame displays the key legend.

Above the key legend is an area reserved for a text message. When an option is selected in the left frame, it is highlighted in white. Often a text message will accompany it.

#### ■ System time / System date

Use this option to change the system time and date. Highlight System Time or System Date using the <Arrow> keys. Enter new values through the keyboard. Press the <Tab> key or the <Arrow> keys to move between fields. The date must be entered in MM/DD/YY format. The time must be entered in HH:MM:SS format.

## 4.2.2 Advanced BIOS Features

Select the Advanced tab from the UTX-3115 setup screen to enter the Advanced BIOS Setup screen. You can select any of the items in the left frame of the screen, such as CPU Configuration, to go to the sub menu for that item. You can display an Advanced BIOS Setup option by highlighting it using the <Arrow> keys. All Advanced BIOS Setup options are described in this section. The Advanced BIOS Setup screen is shown below. The sub menus are described on the following pages.

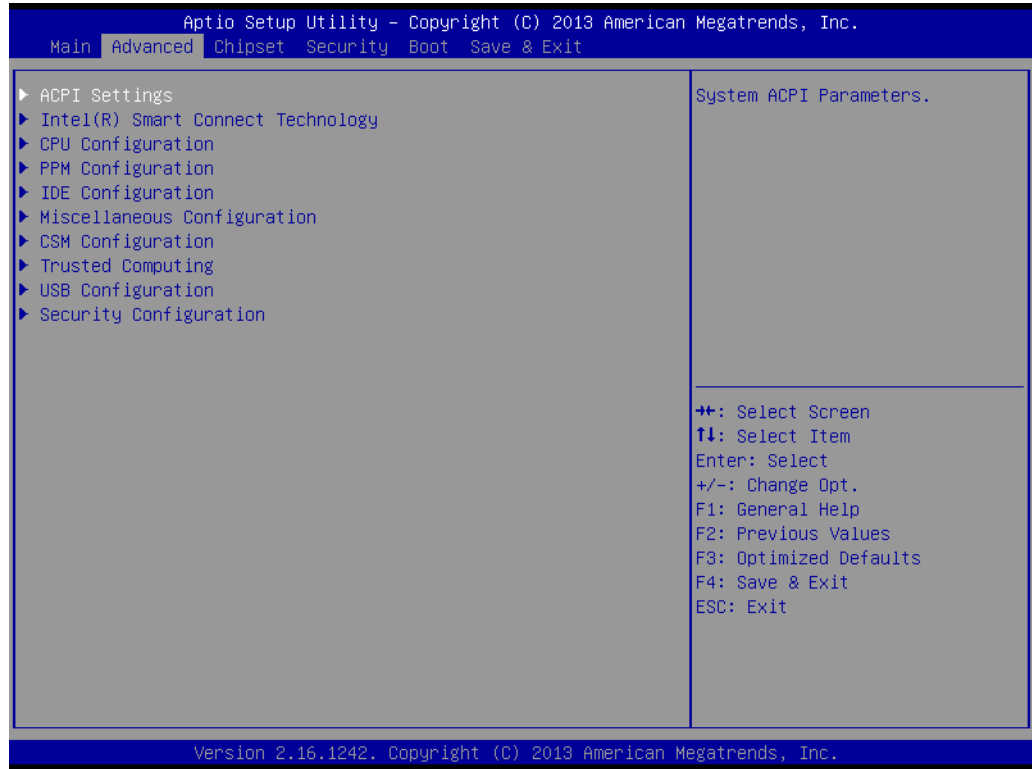



### 4.2.2.1 APCI Subsystem settings

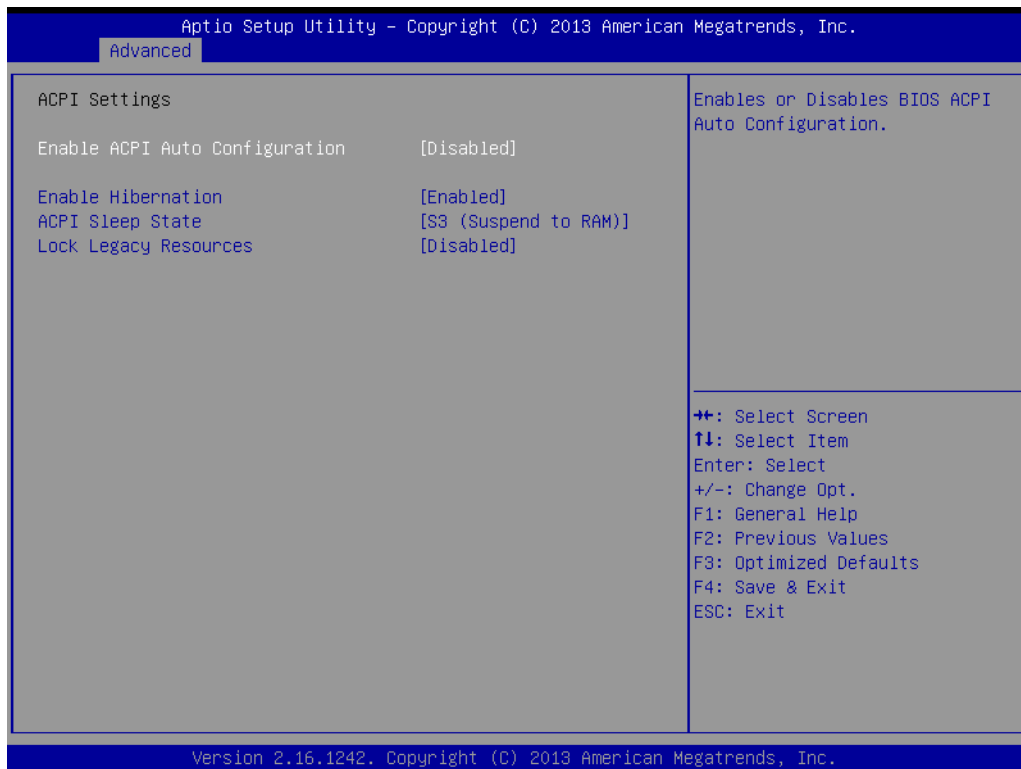

- **Enable ACPI Auto Configuration**  
Enable or disable BIOS ACPI auto configuration.
- **Enable Hibernation**  
Enables or Disables System ability to Hibernate (OS/S4 Sleep State). This option may be not effective with some OS.
- **ACPI Sleep State**  
Select the highest ACPI sleep state the system will enter when the SUSPEND button is pressed.
- **Lock Legacy Resource**  
This item allows users to lock legacy devices' resources

## 4.2.2.2 Intel Smart Connect Technology



- **ISCT Support**  
Enable/Disable BIOS ISCT support.

## 4.2.2.3 CPU configuration

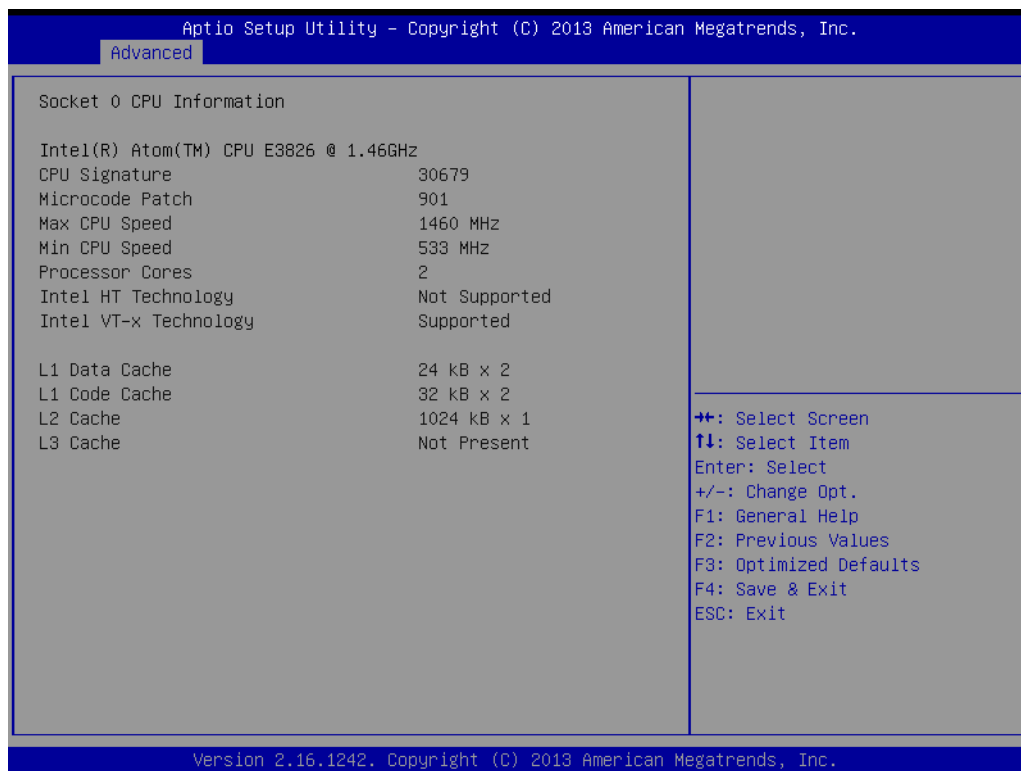

#### 4.2.2.4 CPU configuration



- **Limit CPUID Maximum**  
This item allows you to limit CPUID maximum value.
- **Execute Disable Bit**  
This item allows users to enable or disable the No-Execution page protection.
- **Intel Virtualization Technology**  
When enabled, a VMM can utilize the additional hardware capabilities provided by Vanderpool Technology.

#### 4.2.2.5 PPM configuration



- **CPU C state Report**  
Enable/Disable CPU C state report to OS.
- **Max CPU C-state**  
This option controls Max C state that the processor will support.
- **S0ix**  
Enable/Disable CPU S0ix state.

### 4.2.2.6 IDE configuration

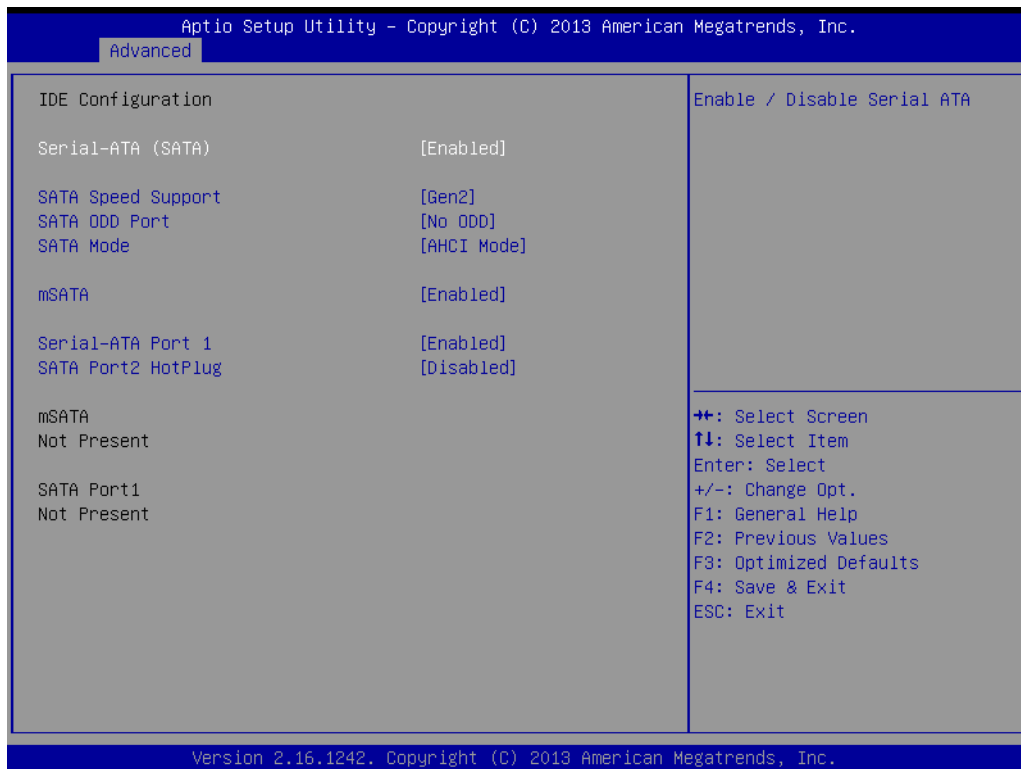

- **Serial-ATA (SATA)**  
Enable / Disable Serial ATA.
- **SATA Speed Support**  
SATA Speed Support Gen1 or Gen2.
- **SATA ODD Port**  
SATA ODD is Port0 or Port1.
- **SATA Mode**  
Select IDE / AHCI.
- **mSATA**  
Enable / Disable mSATA function.
- **Serial-ATA Port 0**  
Enable / Disable Serial ATA Port.
- **SATA port2 HogPlug**  
Enable / Disable Serial ATA Port 2 hot plug function.

## 4.2.2.7 Miscellaneous configuration

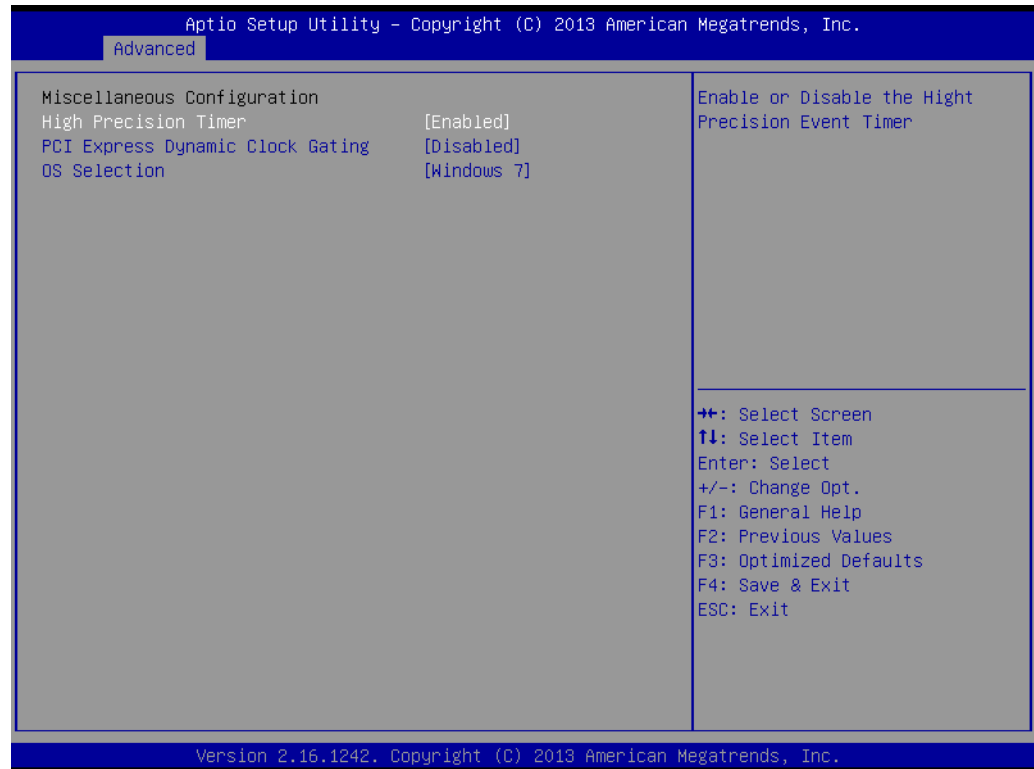

- **High Precision Timer**  
Enable or Disable the High Precision Event Timer.
- **PCI Express Dynamic Clock Gating**  
This items allow user to adjust PCI express clock.
- **OS selection**  
OS Selection to choose Windows 8.X / Windows 7/Android(Linux).

### 4.2.2.8 Compatibility Support Module Configuration

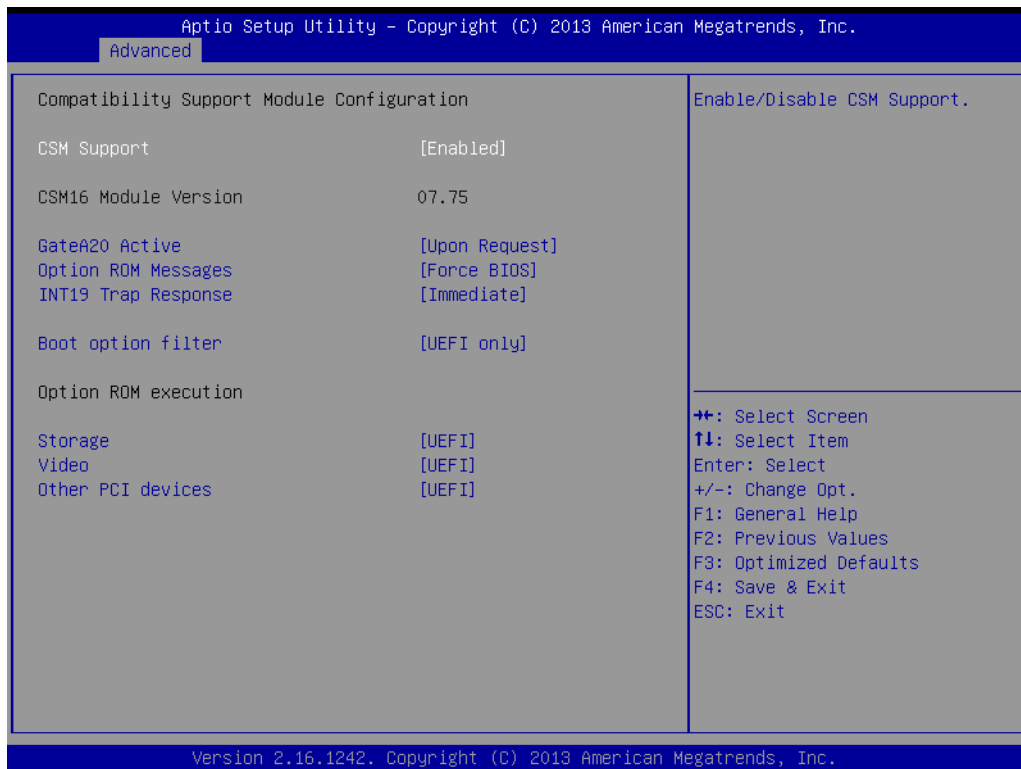

- **CSM Support**  
Enable/Disable CSM Support.
- **GateA20 Active**  
UPON REQUEST - GA20 can be disabled using BIOS services. ALWAYS – do not allow disabling GA20; this option is useful when any RT code is executed above 1 MB.
- **Option ROM Messages**  
Set display mode for Option ROM.
- **INT19 Trap Response**  
BIOS reaction on INT19 trapping by Option ROM: IMMEDIATE - execute the trap right away; POSTPONED - execute the trap during legacy boot.
- **Boot option filter**  
This option controls Legacy/UEFI ROMs priority.
- **Network**  
Controls the execution of UEFI and Legacy PXE OpROM.
- **Storage**  
Controls the execution of UEFI and Legacy Storage OpROM.
- **Video**  
Controls the execution of UEFI and Legacy Video OpROM.
- **Other PCI devices**  
Determines OpROM execution policy for devices other than Network, Storage, or Video.

## 4.2.2.9 Configuration

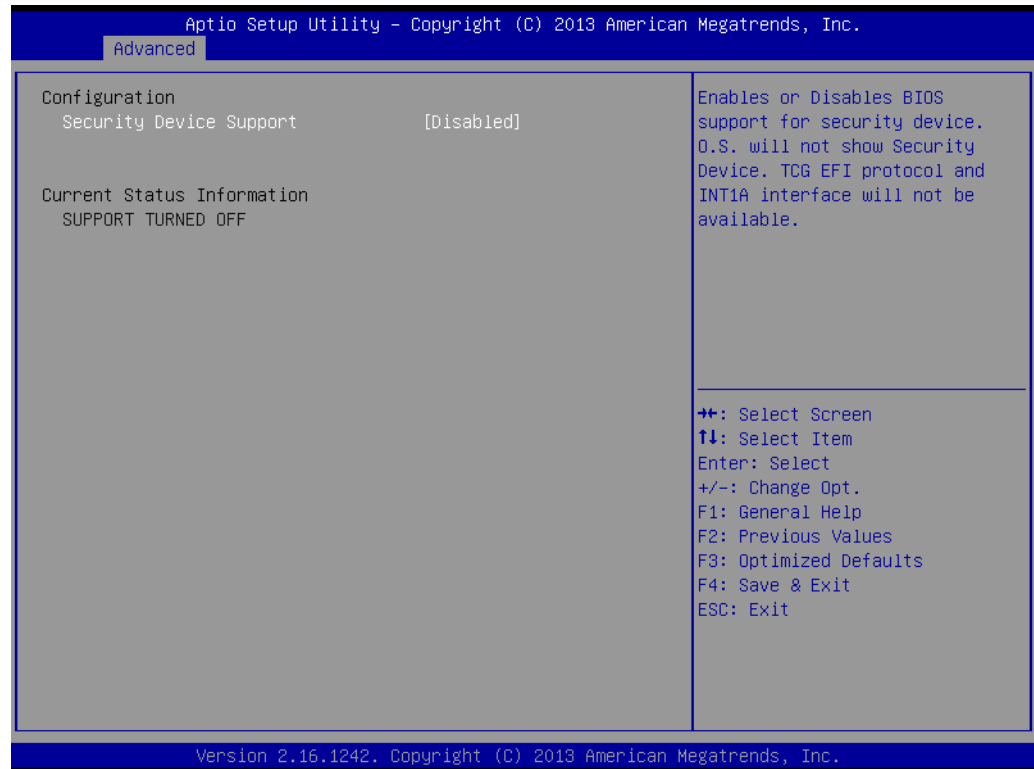

- **Security Device Support**  
Enable or Disable BIOS support for security device.



### 4.2.2.10 USB Configuration

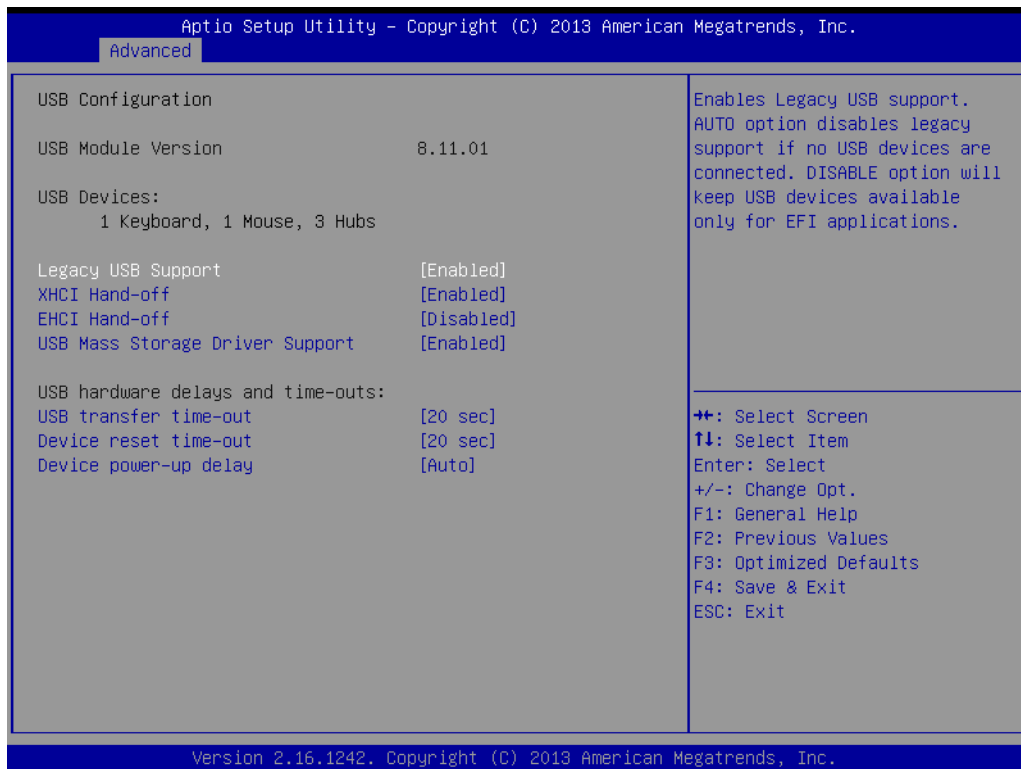

- **Legacy USB Support**  
Enables support for legacy USB. Auto option disables legacy support if no USB devices are connected. DISABLE option will keep USB devices available only for EFI applications.
- **XHCI Hand-Off**  
This is a workaround for OS without XHCI hand-off support. The XHCI ownership change should claim by XHCI driver.
- **EHCI Hand-Off**  
This is a workaround for OS without EHCI hand-off support. The EHCI ownership change should claim by EHCI driver.
- **USB Mass Storage Driver Support**  
This item allows you to enable or disable the USB mass storage device support.
- **USB transmit time-out**  
USB mass storage device transmit command time-out.
- **Device reset time-out**  
USB mass storage device start unit command time-out.
- **Device power-up delay**  
Maximum time the device will take before it properly report itself to the host controller. "Auto" uses default value: for a Root port it is 100ms, for a Hub port the delay is taken from Hub descriptor.

## 4.2.2.11 Intel® TXE Configuration

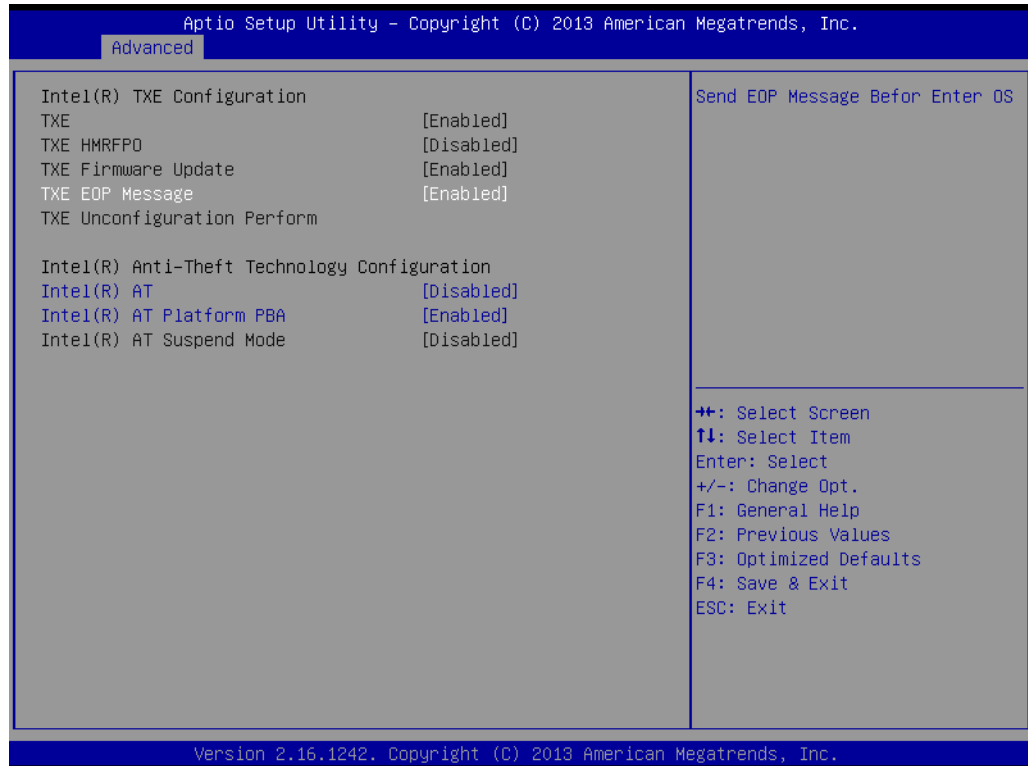

- **SMART Self Test**  
This item allows you to enable or disable the SMART self test function.
- **TXE**  
This item allows you to enable or disable TXE function.
- **TXE HMRFP0 Disable**  
This item allows you to enable or disable TXE HMRFP0 function.
- **TXE Firmware Update**  
This item allows you to update TXE firmware when enable.
- **TXE EOP Message**  
Send EOP Message Before Entering OS.
- **Intel(R) AT**  
Enable/Disable BIOS AT Code from Running.
- **Intel(R) AT Platform PBA**  
Enable/Disable BIOS AT Code from Running.
- **Intel(R) AT Suspend mode**  
Enable/Disable BIOS AT suspend mode.

### 4.2.3 Chipset

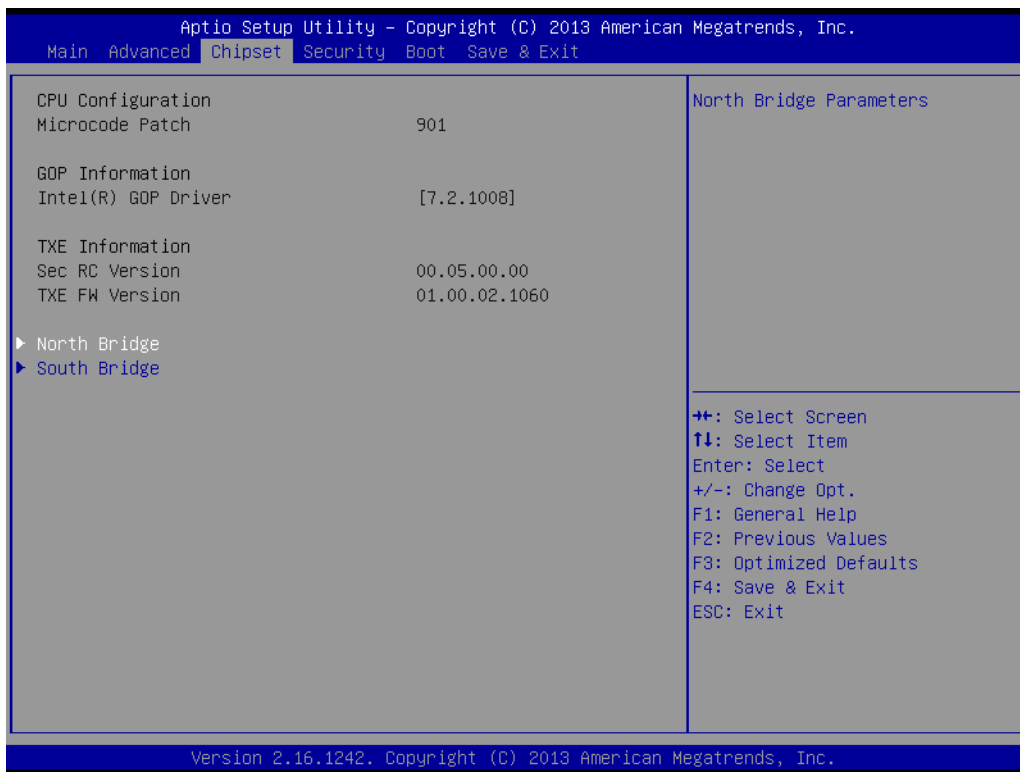

- **North Bridge**  
Detail of North Bridge parameters.
- **South Bridge**  
Details of South bridge parameters.

### 4.2.3.1 Host Bridge / Intel IEGD Configuration

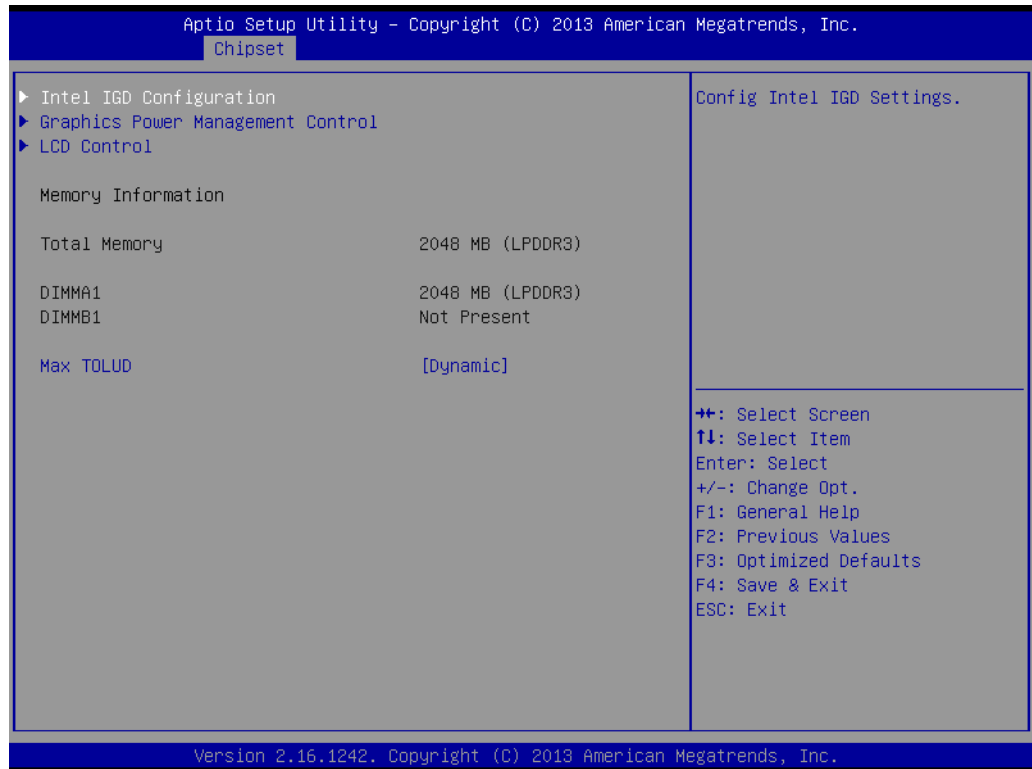

- **Intel IGD Configuration**  
Configure Intel IGD Settings.
- **Graphics Power Management Control**  
Graphics Power Management Control Options.
- **LCD Control**  
LCD Control.
- **Memory Information**  
Memory Frequency and timing setting information.
- **Max TOLUD**  
Maximum Value of TOLUD.

### 4.2.3.2 GOP and Intel IGD Configuration

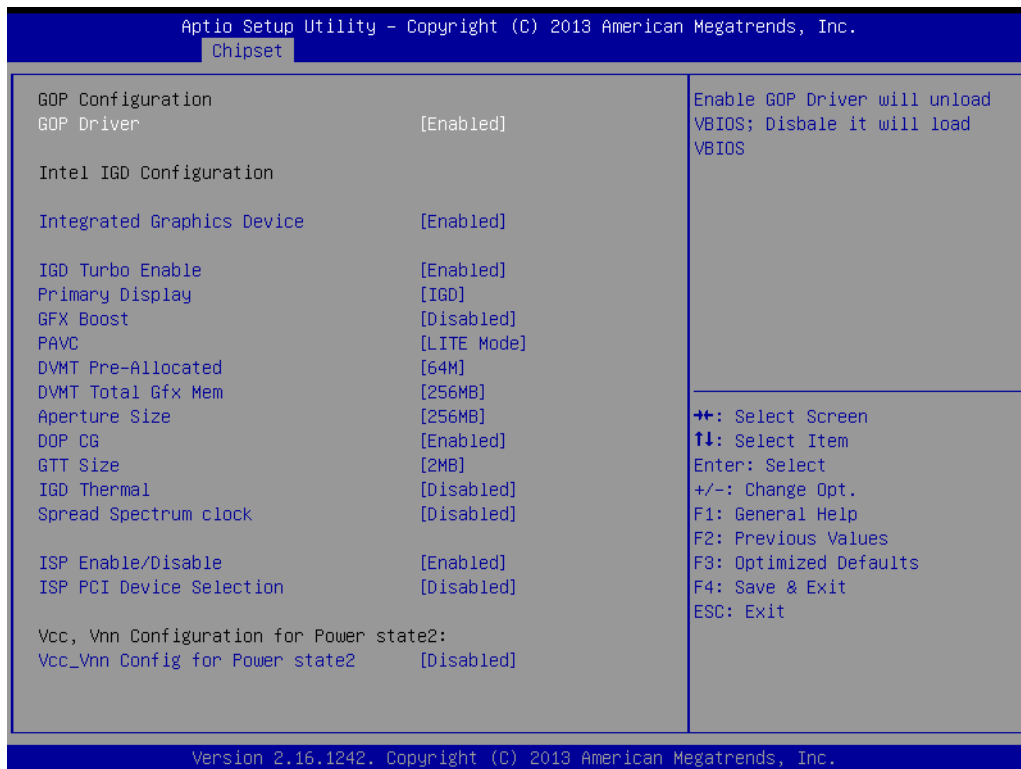

- **GOP Configuration**  
Enable GOP Driver will unload VBIOS; Disable it will load BIOS.
- **Integrated Graphic Device**  
Enable or Disable Intel integrated graphic device.
- **IGD Turbo Enable**  
Enable or Disable IGD Turbo function.
- **Primary Display**  
This item allows users to select the video device which will be activated during POST.
- **GFX Boost**  
This item allows users to enable or disable GFX Boost function.
- **PAVC**  
Enable/Disable Protected Audio Video Control.
- **DVMT Pre-Allocated**  
Select DVMT 5.0 Pre-Allocated (Fixed) Graphics Memory size used by the Internal Graphics Device.
- **DVMT Total Gfx Mem**  
Select DVMT 5.0 Total Graphic Memory size used by the Internal Graphics Device.
- **Aperture Size**  
Select the Aperture Size.
- **DOP CG**  
This item allows users to enable/disable DOP Clock Gating.
- **GTT Size**  
Select the GTT Size.

- **IGD Thermal**  
Enable/Disable IGD Thermal.
- **Spread Spectrum clock**  
Enable/Disable Spread Spectrum clock.
- **ISP Enable/Disable**  
This item allows users to enable/disable ISP PCI Device Selection.
- **ISP PCI Device Selection**  
Default ISP is PCI B0D2F0 for Window Boot. Linux Boot to select B0D3G0.
- **VCC\_Vnn for Power Stage2**  
This item allows users to enable/disable VCC\_Vnn power stage.

#### 4.2.3.3 Graphic Power Management Control

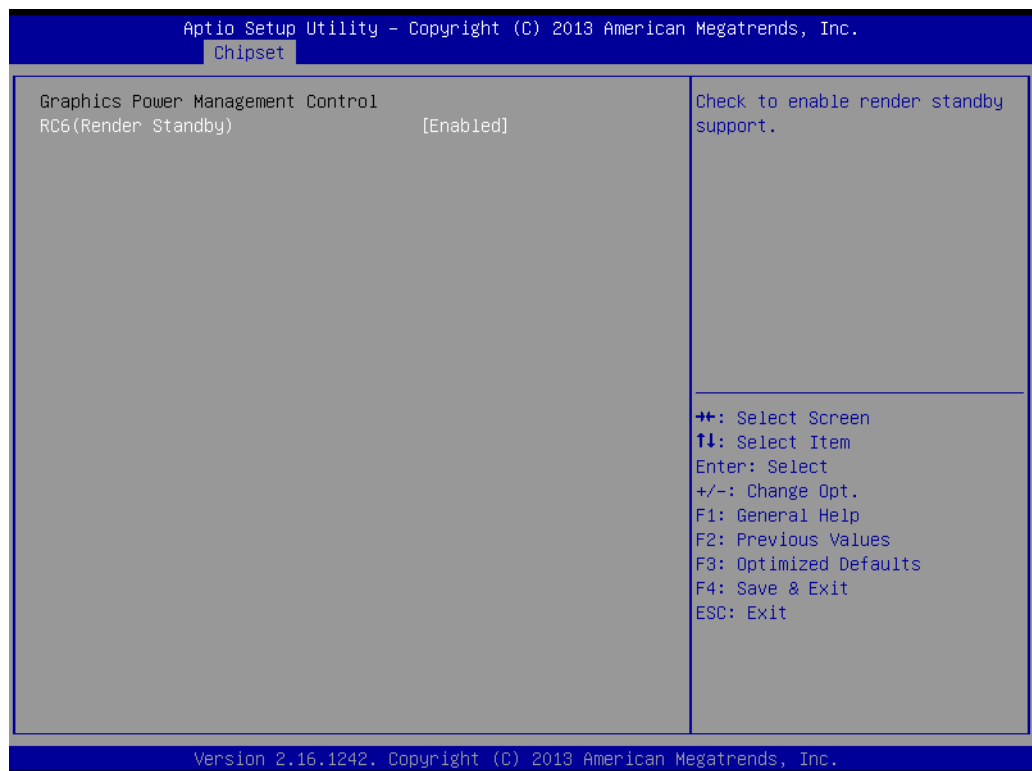

- **RC6 (Render Standby)**  
Check to enable render standby support.

#### 4.2.3.4 LCD Control



- **Primary IGFX Boot Display**  
Select the Video Device which will be activated during Post. VGA mode will be supported only on Primary display.
- **LVDS Panel Type**  
Enable or disable LVDS function.

### 4.2.3.5 South Bridge

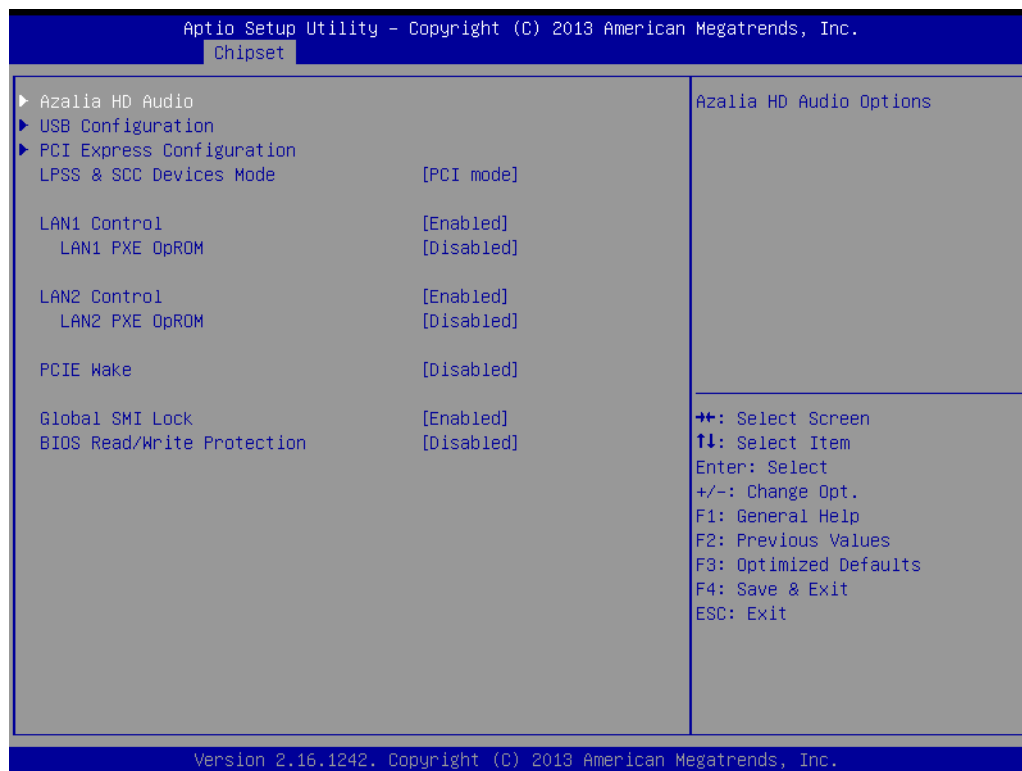

- **Azalia HD Audio**  
Azalia HD Audio Options.
- **USB Configuration**  
USB Configuration Settings.
- **PCI Express Configuration**  
PCI Express Configuration settings.
- **LAN1 Control**  
Enable or Disable the LAN1.
- **LAN1 PXE OpROM**  
Enable or Disable boot option for LAN1 Controller.
- **LAN2 Control**  
Enable or Disable the LAN2.
- **LAN2 PXE OpROM**  
Enable or Disable boot option for LAN2 Controller.
- **PCIE Wake**  
Enable or Disable PCIE to wake the system from S5.
- **Global SMI Lock**  
Enable or Disable SMI lock.
- **BIOS Read/Write Protection**  
Enable or Disable BIOS SPI region read/write protect.



### 4.2.3.6 Audio Configuration

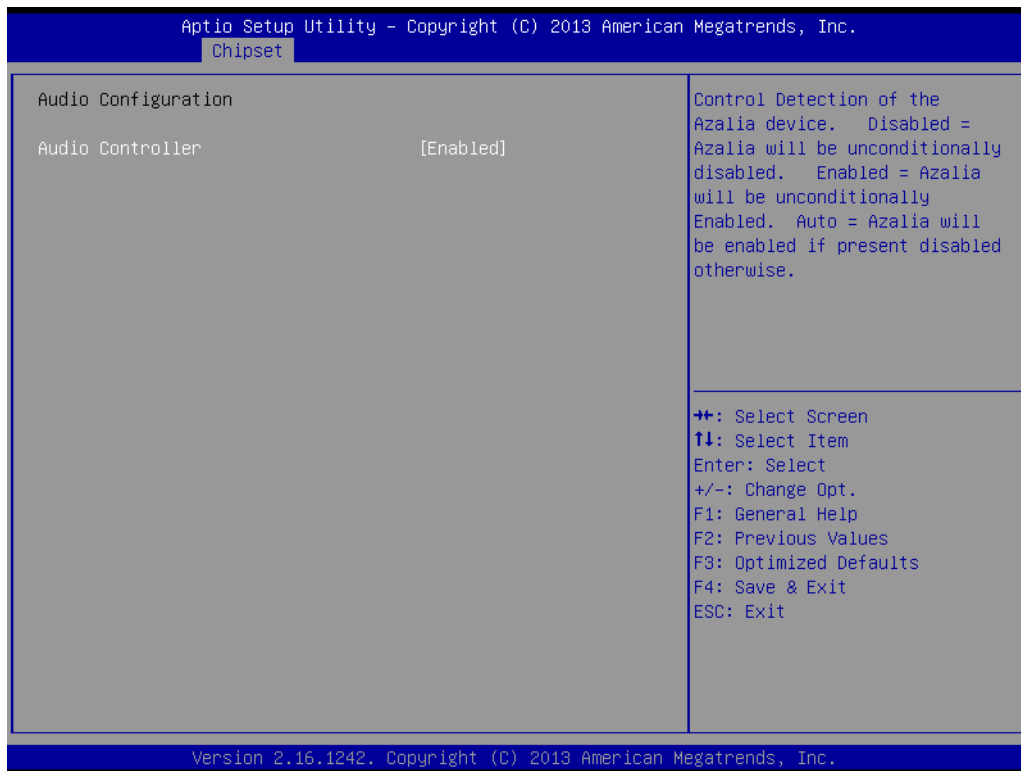

- **Audio Controller**  
Enable or disable SB Azalia Device.

### 4.2.3.7 USB Configuration

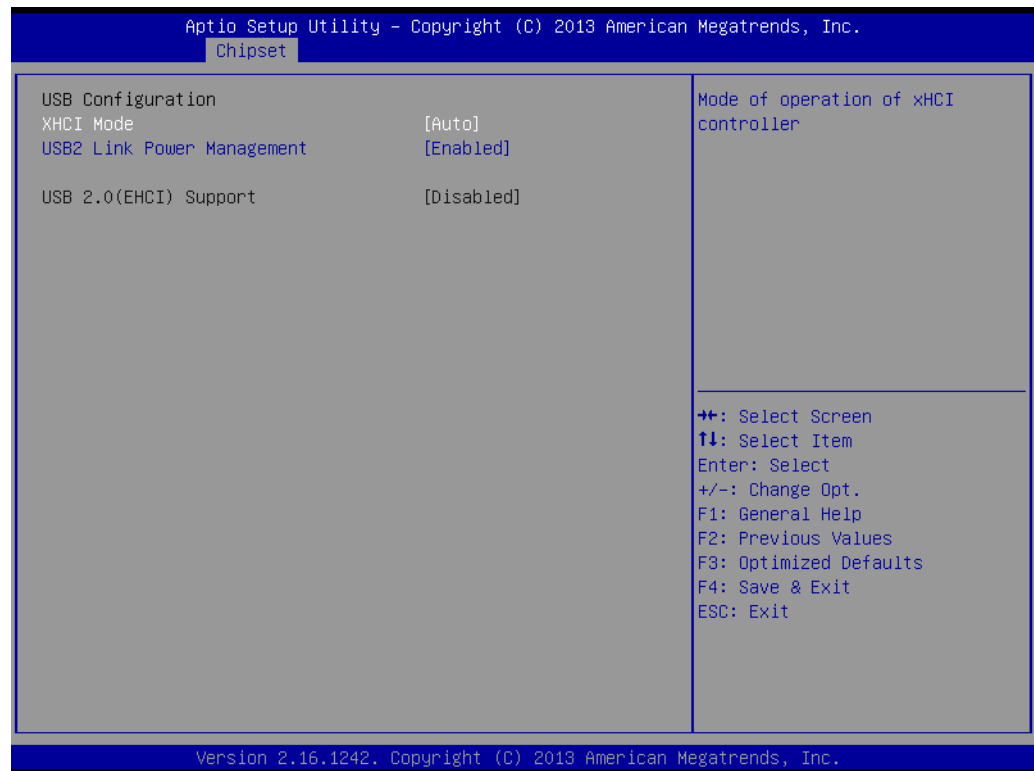

- **XHCI Mode**  
Mode of operation of XHCI controller.
- **USB2 Link Power Management**  
Enable/Disable USB2 Link Power Management.
- **USB 2.0(EHCI) Support**  
Control the USB EHCI (USB 2.0) functions. One EHCI controller must always be enabled.

### 4.2.3.8 PCI Express Configuration

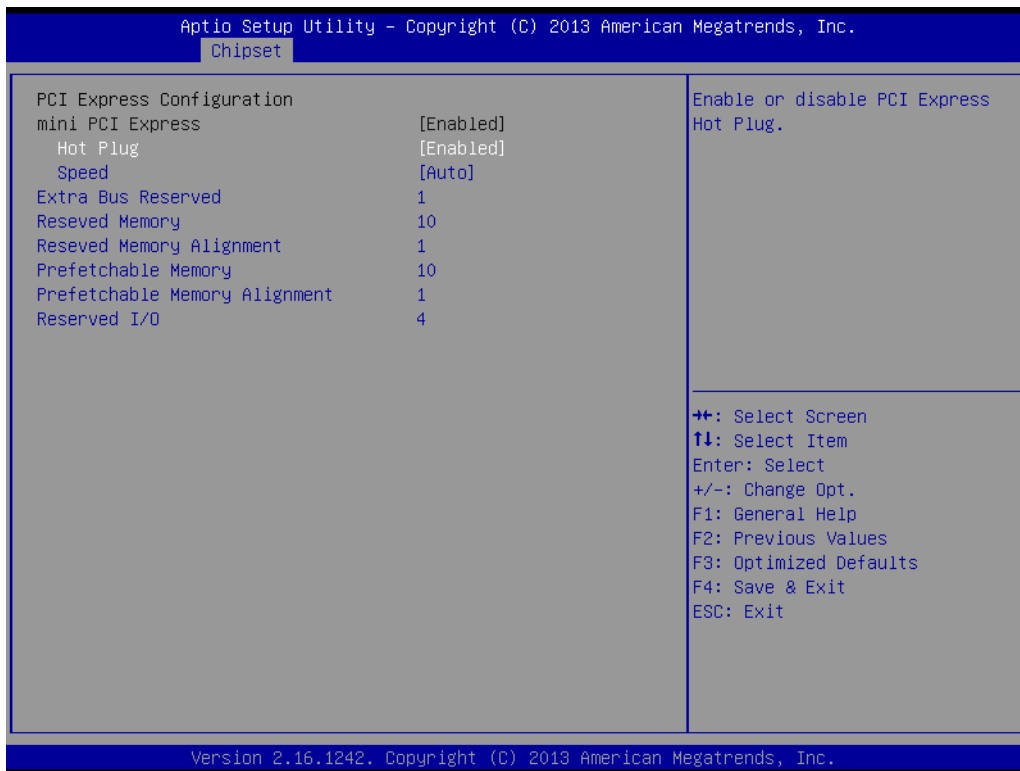

- **Mini PCI Express**  
Enable or disable Mini PCI Express port.
- **Hot Plug**  
This item allow user to enables or disables miniPCIE hot plug function.
- **Speed**  
Configure PCIe Port Speed.

## 4.2.4 Security

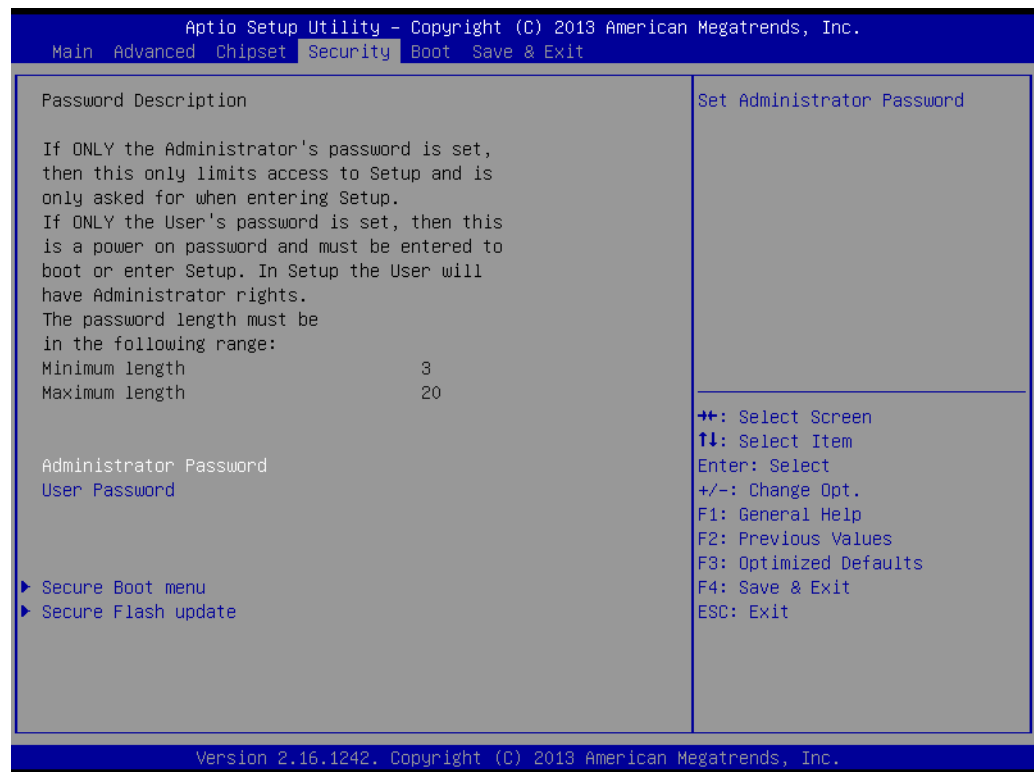

Select Security Setup from the AIMB-115/UTX-3115 Setup main BIOS setup menu. All Security Setup options, such as password protection and virus protection are described in this section. To access the sub menu for the following items, select the item and press<Enter>: Change Administrator / User Password.

### 4.2.4.1 Security

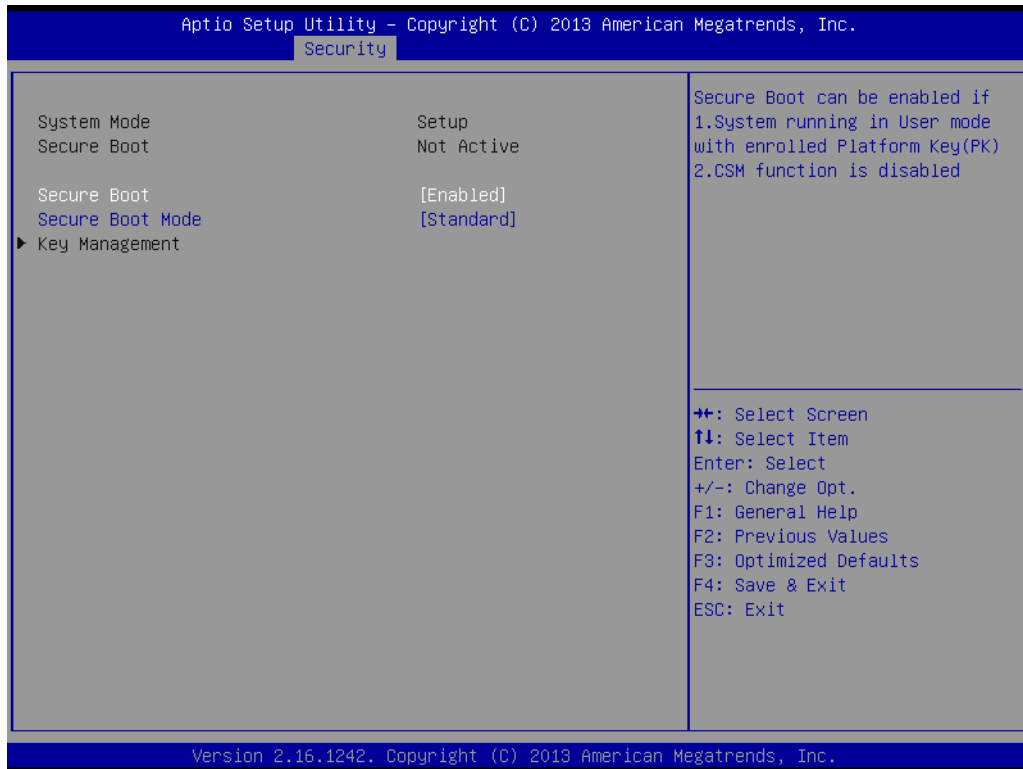

- **Secure Boot**  
Enable or disable secure boot function.
- **Secure Boot Mode**  
This item allow user to select secure boot mode.

## 4.2.5 Boot

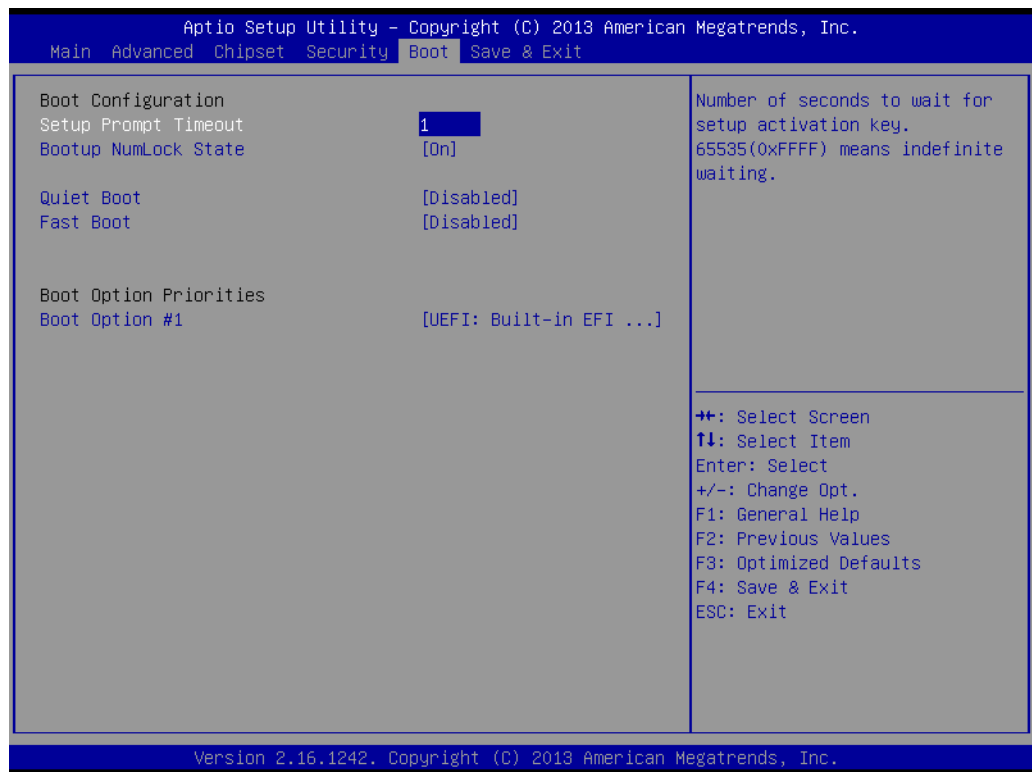

- **Setup Prompt Timeout**  
Number of seconds that the firmware will wait before initiating the original default boot selection. A value of 0 indicates that the default boot selection is to be initiated immediately on boot. A value of 65535(0xFFFF) indicates that firmware will wait for user input before booting. This means the default boot selection is not automatically started by the firmware.
- **Bootup NumLock State**  
Select the keyboard NumLock state.
- **Quiet Boot**  
Enables or disables Quiet Boot option.
- **Fast Boot**  
Enables or disables boot with initialization of a minimal set of devices required to launch active boot option. Has no effect for BBS boot options.
- **Boot Option #1**  
Sets the system boot order.

## 4.2.6 Save & Exit

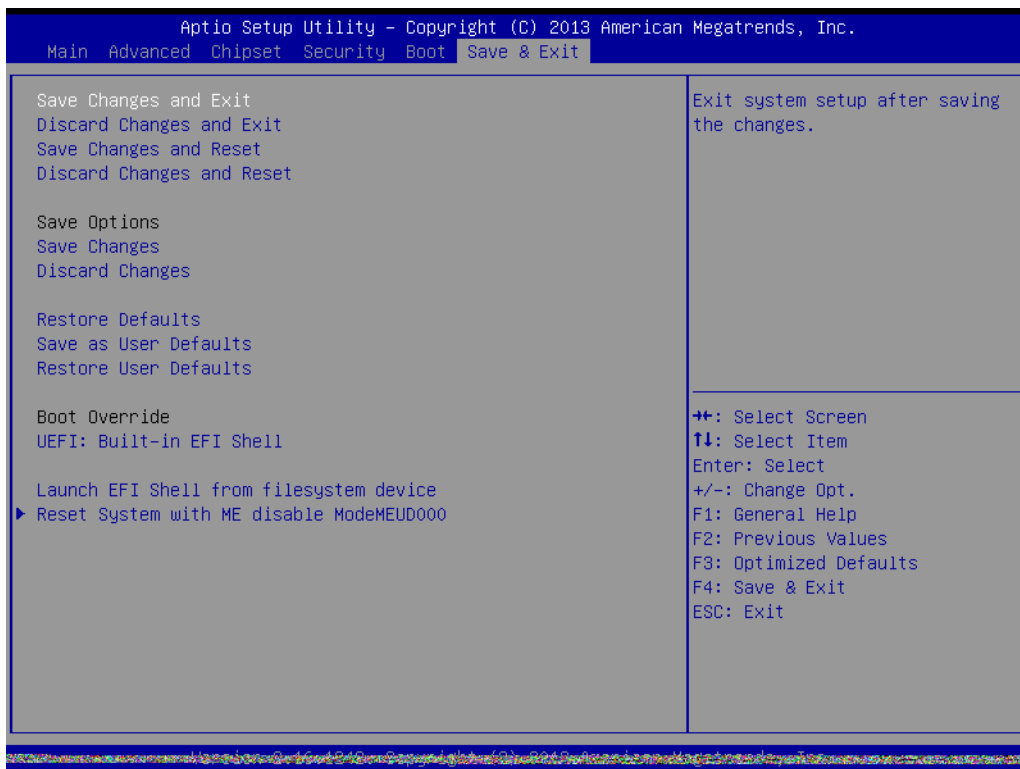

- **Save Changes and Exit**  
This item allows you to exit system setup after saving changes.
- **Discard Changes and Exit**  
This item allows you to exit system setup without saving any changes.
- **Save Changes and Reset**  
This item allows you to reset the system after saving the changes.
- **Restore Defaults**  
This item allows you to restore/load default values for all the options.
- **Save Changes**  
This item allows you to save changes done so far to any of the options.
- **Discard Changes**  
This item allows you to discard changes done so far to any of the options.
- **Restore Defaults**  
This item allows you to restore/load default values for all the options.
- **Save as User Defaults**  
This item allows you to save the changes done so far as user defaults.
- **Restore User Defaults**  
This item allows you to restore the user defaults to all the options.
- **Boot Override**  
Boot device select can override your boot priority.