

## Features

- Solo/Dual/Quad iMX6 ARM Cortex A9 Fanless
- 800 MHz, 1 GHz, Up to 1.2 GHz Processor Speed
- Up to 2 GB of DDR3 RAM
- 4 GB of eMMC Flash, 16 MB Serial Data Flash
- 1x 1000 Ethernet, SATA, A/D, SPI, I2C, I2S & CAN
- 3x USB, 4x Serial Ports, 2x SDIO
- Wide Temperature -40° to +85° C
- HDMI /LVDS Dual Video with Touch Controller
- 1x PCIe 2.0 Port



## Specifications

Processor	Freescale Solo/Dual/Quad iMX6 ARM Cortex A9 Fanless Processor 1 GHz (800 MHz, Up to 1.2 GHz Minimum Order Quantities Apply)
Memory	Up to 2 GB DDR3 RAM 4 GB of eMMC Flash 16 MB of Serial Data Flash (depends on processor) Micro SD Card interface with Status LED
IO	16x GPIO 2x SDIO, 1x SATA 2x I2S, 1x SPDIF 2x CAN Ports 1x 1000 BaseT Ethernet with Status LEDs 2x USB 2.0 High Speed Host Ports 1x USB 2.0 High OTG (Host/Device) 4x Serial Ports with Handshake 2x SPI Ports 2x Timer/Counters/4x PWMs 4x I2C Ports Programmable LED
Video	24-bit LVDS / HDMI 1x Serial Video Capture (CSI) Port 4-wire Analog Resistive Touch Controller
Analog	4x A/D Channels with 12-bit A/D Resolution
Bus Expansion	1x PCIe
OS	EMAC OE Linux
Dimensions	314 pin MXM EM4C G2 Microcontroller SODIMM 3.23" x 2.363" (82mm x 60mm)
Power Req.	5 V
Environment	-40° to +85° C Industrial Wide Temperature 90% Upper Operating Humidity



## Block Diagram

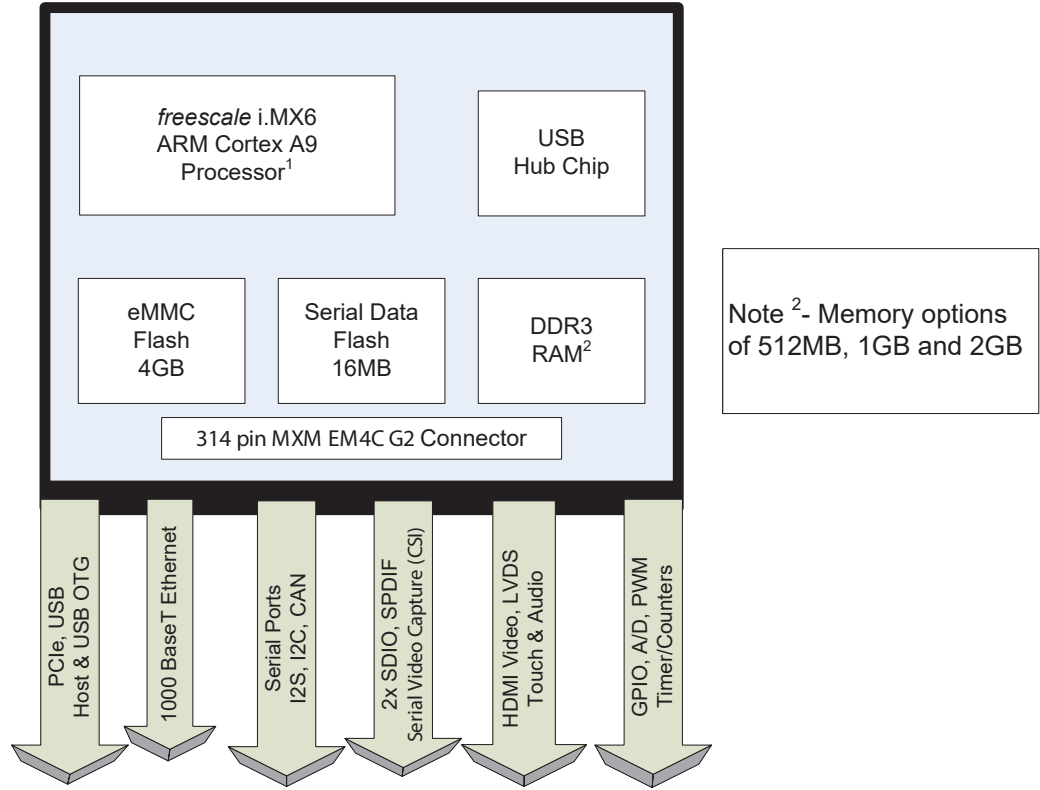

## Ordering Information

Product #	CPU	Memory	Serial	GPIO	USB	Video	LAN	Temperature
SOM-iMX6M-131 (Solo)	iMX6 ARM Cortex A9 800 MHz	512MB DDR3 4GB eMMC	4x	16x	2x HS Host 1x OTG	HDMI/LVDS with Touch	1x 1000 BaseT w/Status LEDs	0° to +60° C
SOM-iMX6M-352 (Dual)	iMX6 ARM Cortex A9 1 GHz	1GB DDR3 4GB eMMC 16MB Serial Flash	4x	16x	2x HS Host 1x OTG	HDMI/LVDS with Touch	1x 1000 BaseT w/Status LEDs	-40° to +85° C
SOM-iMX6M-354 (Quad)	iMX6 ARM Cortex A9 1 GHz	2GB DDR3 4GB eMMC 16MB Serial Flash	4x	16x	2x HS Host 1x OTG	HDMI/LVDS with Touch	1x 1000 BaseT w/Status LEDs	-40° to +85° C

## Carrier Board Options

PRODUCT #	DESCRIPTION
SOM-350ES-000	Standard Carrier Board SoM OEM 314-Pin 7" LCD 800x480 WVGA without Wi-Fi
SOM-350ES-017	Deluxe Standard Carrier Board SoM OEM 314-pin with Wi-Fi
SoM-350-ES-011	Deluxe Carrier Board 10" LCD 1024 x 600 WSVGA with Wi-Fi

## Optional Accessories

PRODUCT #	PERIPHERALS
PER-FAN-00013-AR	Heat Spreader option for the Dual & Quad
PER-MIS-00048	2.4 GHz WiFi Antenna & 20 cm Cabel

