

Our Products Make Your Product Better®

To learn more about EMAC's products and services and how they can help your project

http://ftp.emacinc.com/Tech_Info/About_EMAC_Products_and_Services.pdf

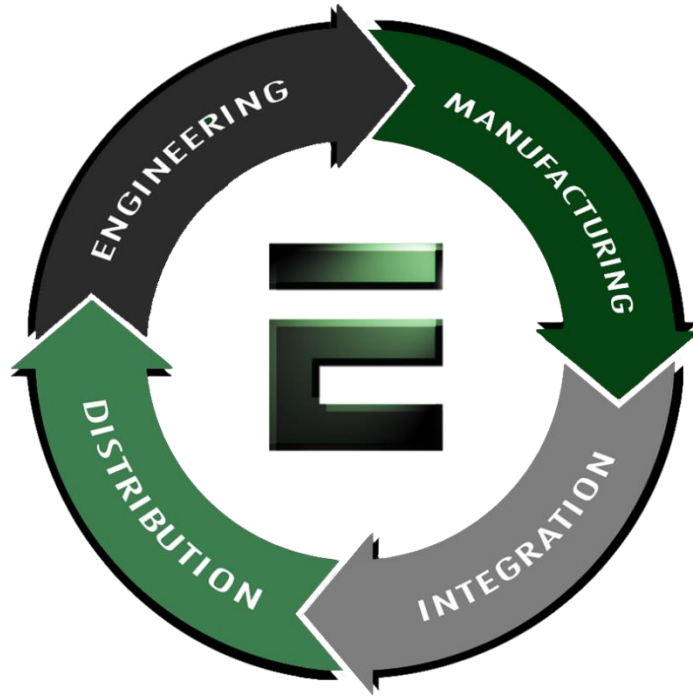

Authorized Distributor, Integrator, and Value-Added Reseller

Manual downloaded from <ftp.emacinc.com>

For purchase information please contact info@emacinc.com

For technical support please submit a ticket at www.emacinc.com/support



APL-PITX-N3350-N

A Pico-ITX embedded solution on
Intel® Dual-core processor
(Apollo Lake Family)

Version 1.0

Copyright

The information in this manual is subject to change without notice for continuous improvement in the product. All rights are reserved. The manufacturer assumes no responsibility for any inaccuracies that may be contained in this document and makes no commitment to update or to keep current the information contained in this manual.

No part of this manual may be reproduced, copied, translated or transmitted, in whole or in part, in any form or by any means without the prior written permission of ICOP Technology Inc.

Copyright © 2019 ICOP Technology Inc

Trademarks Acknowledgement

Intel® is the registered trademark of Intel Semiconductor Manufacturing Company. Other brand names and product names that appear in this document are the properties and registered trademarks of their respective owners. All names mentioned herewith are served for identification purpose only.

Revision History

Revision	Date	Remark
1.0	May 1st, 2022	First version release

Contents

1	General Information.....	1
1.1	Overview.....	1
1.2	Block diagram.....	1
1.3	Specifications.....	2
1.4	Ordering Information.....	3
1.4.1	APL-PITX-N3350.....	3
2	Hardware Information.....	4
2.1	Board Outline.....	4
2.2	Connector, Header, and Jumper Summary.....	5
2.3	Pin Assignments & Jumper Settings.....	6
3	Technical Support Directly from ICOP.....	21
	User Manual Feedback.....	21
	Warranty.....	22

1 General Information

1.1 Overview

APL-PITX-N3350, a standard Pico-ITX embedded solution for industrial application based on Intel® Apollo Lake Dual-Core CPU with DDR3L RAM support up to 8GB, provides stable and powerful computing performance.

APL-PITX-N3350 supports Gigabit LAN, 2x COM, 4x USB, SMBus, 8-bit GPIO, SIM card holder, MiniPCIe, HDMI, LVDS and 2 storage options SATA interface and M.2 SATA interface for development use.

1.2 Block diagram

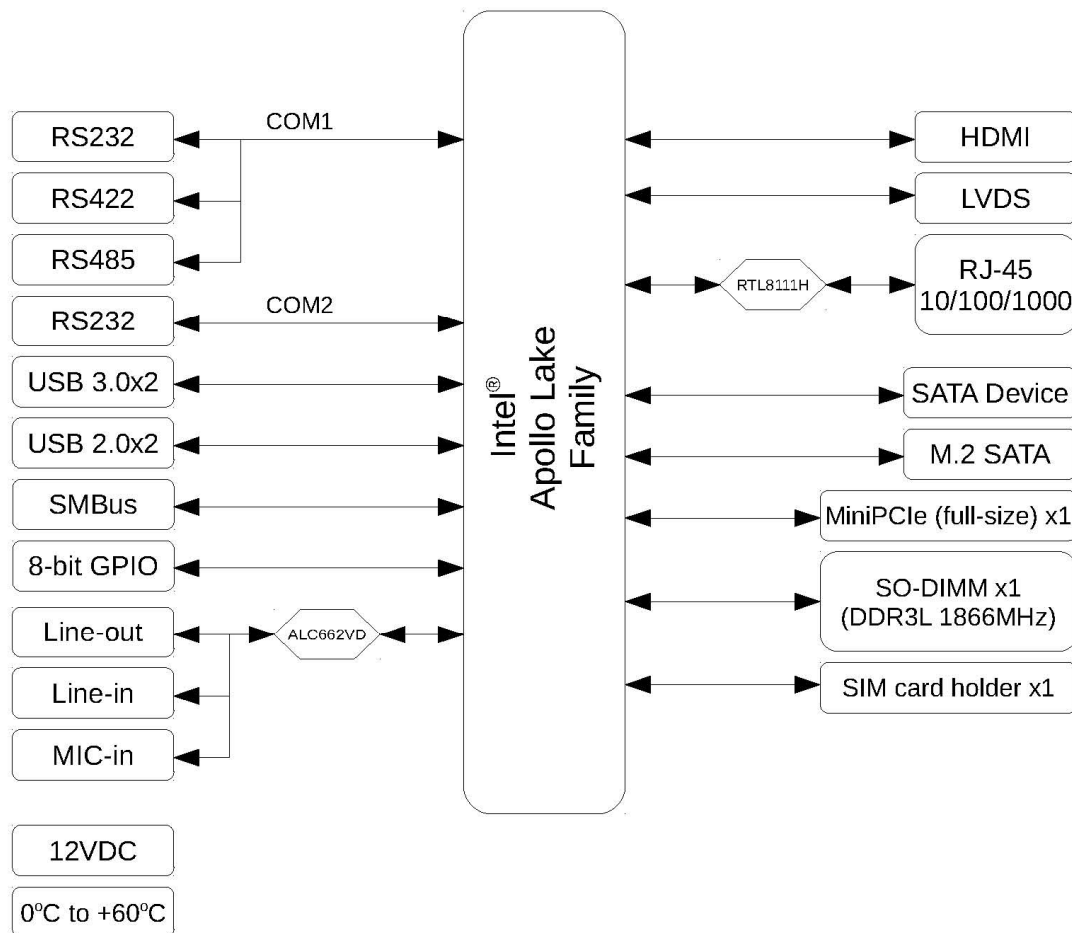

1.3 Specifications

Processor	Intel® Apollo Lake N3350 2.40GHz (Burst) 1.10GHz Dual Core		
System memory	DDR3L 1866MHz memory support up to 8GB in SO-DIMM slot x1		
BIOS	AMI BIOS		
Display	Intel® HD Graphics with MultiDisplay support HDMI: resolution support up to 3840 x 2160 at 60Hz LVDS: resolution support up to 1920 x 1080 at 60Hz		
Audio	Realtek ALC662VD/ALC888S HD Audio (Default)		
LAN	Realtek 8111H Gigabit Ethernet Controller		
Expansion	MiniPCIe (full-size) x1		
Disk Support	M.2 SATA x1	SATA interface x1	
I/O Interface	8-bit GPIO x1	COM x2 (RS232/422/485 x1)	SMBus x1
	SIM card holder x1	USB (ver. 3.0) x2	USB (ver. 2.0) x2
Connectors	2-pin header for Buzzer x1 4-pin header for SMBus x1 4-pin wafer for SATA power output x1 7-pin SATA connector for SATA x1 9-pin header for USB2.0 x1 9-pin header for Line-in, Line-out, and MIC-in x1 9-pin header for COM x2 10-pin header for GPIO x1 30-pin wafer for LVDS x1 HDMI connector x1 M.2 slot (M key 2242) for M.2 SATA x Power jack for 12VDC input x1 RJ45 connector x1 SIM card holder x1 USB connector for USB3.0 x2		
Power Requirement	12VDC ATX power input with ATX/AT mode		
Operating Temp.	0°C to 60°C		
Dimensions	100 x 72 mm		
O/S Support	Windows 10	Linux	

1.4 Ordering Information

1.4.1 APL-PITX-N3350

Product Name	APL-PITX-N3350
Processor	Intel® Apollo Lake N3350 2.40GHz (Burst) 1.10GHz Dual Core
System Memory	DDR3L 1866MHz memory support up to 8GB in SO-DIMM socket x1
Expansion	MiniPCIe (full size) x1
Disk Support	M.2 SATA, SATA device
Display	HDMI, LVDS
Audio	Line-in, Line-out, MIC-in
GigaLAN	1
COM	2 (1x RS232/422/485)
USB3.0	2
USB2.0	2
SMBus	1
8-bit GPIO	1
SIM Card Holder	Support

2 Hardware Information

2.1 Board Outline

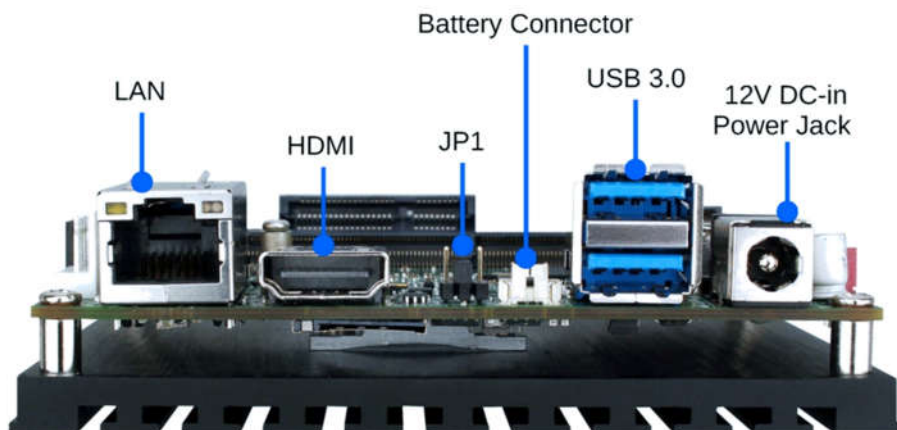
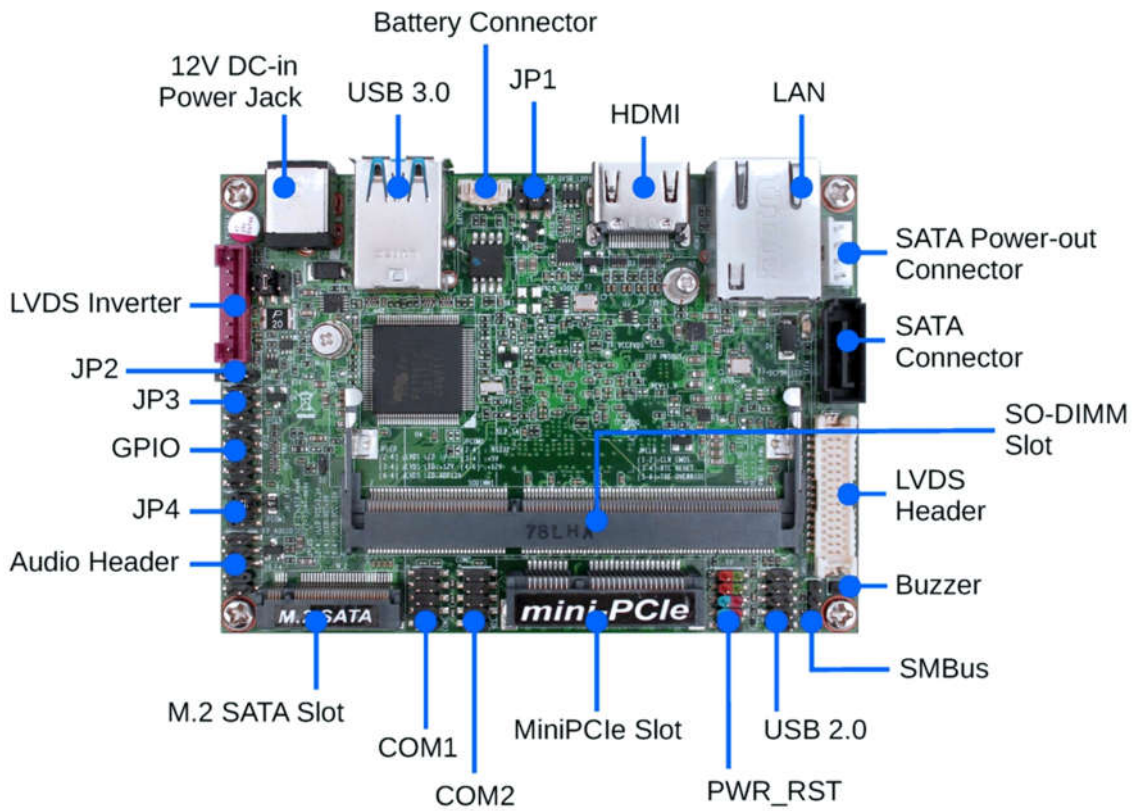

2.2 Connector, Header, and Jumper Summary

Nbr.	Name	Description	Nbr of Pin
JP1	Voltage Select for LVDS voltage	LVDS voltage setting	4
JP2	AT Mode Function Select	AT Mode Function Select Function	3
JP3	Clear CMOS and RTC	Clear CMOS and RTC	6
JP4	Function Select for Pin 9 on COM1	Function setting for Pin9 of COM1	4
---	SATA Connector	7-pin connector for SATA Device	7
---	SATA Power-out Connector	4-pin connector for SATA Power out	4
---	Battery Connector	Connector for RTC battery	2
---	LVDS Inverter	LVDS inverter connector	8
---	GPIO Header	GPIO Port Header	10
---	Audio Header	Pin header for Line-out & MIC-in	9
---	COM1 Header	Pin Header for COM1	9
---	COM2 Header	Pin Header for COM2	9
PWR_RST	Power Button, Reset Button, Power LED, and Hard Disk LED Header	Header for Power Button, Reset Button, Power LED, and Hard Disk LED	8
---	USB2.0 Header	Pin Header for USB2.0 Device	9
---	SMBus Header	Pin Header for SMBus	4
---	Buzzer	Pin Header for Buzzer	2
---	LVDS Header	Pin Header for LVDS Display	30

2.3 Pin Assignments & Jumper Settings

JP1: Voltage Select for LVDS voltage

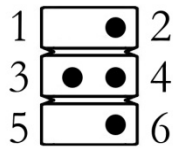

Pin	Status	Assignment
2 – 4	Closed	3.3V
3 – 4	Closed	5V
4 – 6	Closed	12V

JP2: AT Mode Function Select

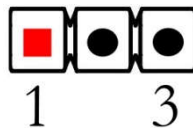

Pin	Status	Assignment
1 – 2	Closed	ATX Mode
2 – 3	Closed	AT Mode

JP3: Clear CMOS and RTC

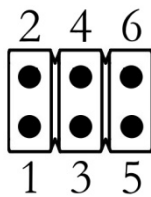

Pin	Status	Assignment
1 – 2	Closed	Clear CMOS(One Touch)
3 – 4	Closed	Reset RTC
5 – 6	Closed	Disabled Security Measures in the Flash Descriptor (Override)

JP4: Function Select for Pin 9 on COM1

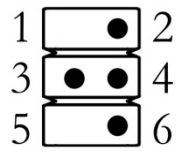

Pin	Status	Assignment
2 – 4	Closed	RS232
3 – 4	Closed	5V
4 – 6	Closed	12V

SATA Connector



Pin	Assignment
1.	GND
2	TXP
3	TXN
4	GND
5	RXN
6	RXP
7	GND

SATA Power-out Connector

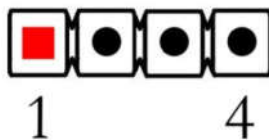

Pin	Assignment
1.	+5V
2	GND
3	GND
4	+12V

LVDS Inverter

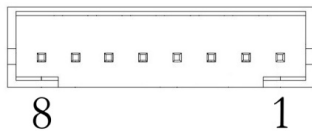

Pin	Assignment
1	Backlight Enable
2	Backlight PWM
3	VCC
4	VCC
5	GND
6	GND
7	Backlight SW+
8	Backlight SW-

GPIO Header

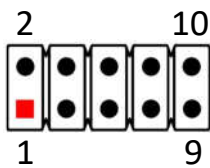

Pin	Assignment	Pin	Assignment
1.	GPIO00	2	GPIO01
3	GPIO02	4	GPIO03
5	GPIO04	6	GPIO05
7	GPIO06	8	GPIO07
9	GND	10	5V

Audio Header

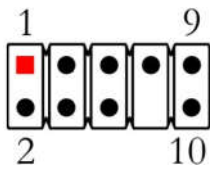

Pin	Assignment	Pin	Assignment
1.	MIC-L	2	GND
3	MIC-R	4	AUDIO-JD
5	LOUT-R	6	MIC-JD
7	SENSE-FB	8	---
9	LOUT-L	10	LINE-JD

COM1 Header

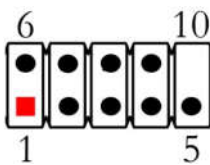

RS232

Pin	Assignment	Pin	Assignment
1.	DCD	6	DSR
2	RXD	7	RTS
3	TXD	8	CTS
4	DTR	9	RI
5	GND	10	NC

RS422

Pin	Assignment	Pin	Assignment
1.	TX-	6	NC
2	TX+	7	NC
3	RX+	8	NC
4	RX-	9	NC
5	GND	10	NC

RS485

Pin	Assignment	Pin	Assignment
1.	DATA-	6	NC
2	DATA+	7	NC
3	NC	8	NC
4	NC	9	NC
5	GND	10	NC

COM2 Header

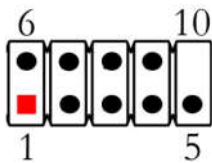

Pin	Assignment	Pin	Assignment
1.	DCD	6	DSR
2	RXD	7	RTS
3	TXD	8	CTS
4	DTR	9	RI
5	GND	10	NC

PWR_RST: Power Button, Reset Button, Power LED, and Hard Disk LED Header

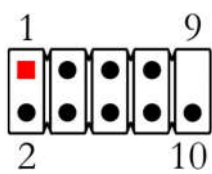

Pin	Assignment	Pin	Assignment
1.	HDD_LED+	2	PWRLED+
3	HDD_LED-	4	PWRLED-
5	GND	6	PWRBTN
7	RSTSW	8	GND
9	VCC	10	NC

USB2.0 Header

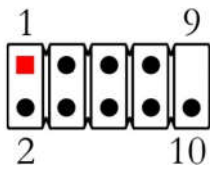

Pin	Assignment	Pin	Assignment
1.	VCC	2	VCC
3	DATA-	4	DATA-
5	DATA+	6	DATA+
7	GND	8	GND
9	---	10	NC

SMBus Header



Pin	Assignment
1	VCC
2	DATA
3	CLK
4	GND

Buzzer

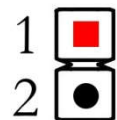

Pin	Assignment
1	Buzzer+
2	Buzzer-

LVDS Header

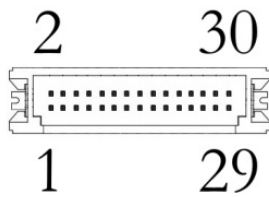

Pin	Assignment	Pin	Assignment
1.	LVDSB_DATAN3	2	LVDSB_DATAP3
3	LVDS_CLKBN	4	LVDS_CLKBP
5	LVDSB_DATAN2	6	LVDSB_DATAP2
7	LVDSB_DATAN1	8	LVDSB_DATAP1
9	LVDSB_DATAN0	10	LVDSB_DATAP0
11	NC/DDC_DATA	12	NC/DDC_CLK
13	GND	14	GND
15	GND	16	GND
17	LVDSA_DATAP3	18	LVDSA_DATAN3
19	LVDS_CLKAP	20	LVDS_CLKAN
21	LVDSA_DATAP2	22	LVDSA_DATAN2
23	LVDSA_DATAP1	24	LVDSA_DATAN1
25	LVDSA_DATAP0	26	LVDSA_DATAN0
27	PVCC	28	PVCC
29	PVCC	30	PVCC

3 Technical Support Directly from ICOP

To offer you more accurate and specific solutions for the technical situations you have, please prepare the information below before contacting ICOP:

—Product name and serial number

—Description of the H/W environment (i.e.: working temperature, I/O board information, information of connection between main board and IO boards, and/or other devices, etc)

—Description of the S/W environment (i.e: operating system, version, application software, and/or other related information, etc.)

—A detailed description and photos of the technical situation

—Any complement or technical situations you want ICOP more focusing on

User Manual Feedback

To make this user manual more complete, if you have any comments or feedbacks to this manual, please feel free to write to info@icop.com.tw or contact your ICOP sales representative.

Warranty

This product is warranted to be in good working order for a period of one year (12 months) from the date of purchase. Should this product fail to be in good working order at any time during this period, we will, at our option, replace or repair it without additional charge except as set forth in the following terms. This warranty does not apply to products damaged by misuse, modifications, accident or disaster. Vendor assumes no liability for any damages, lost profits, lost savings or any other incidental or consequential damage resulting from the use, misuse of, originality to use this product. Vendor will not be liable for any claim made by any other related party. Return authorization must be obtained from the vendor before returned merchandise is accepted. Authorization can be obtained by calling or faxing the vendor and requesting a Return Merchandise Authorization (RMA) number. Returned goods should always be accompanied by a clear problem description. Should you have questions about warranty and RMA service, please contact us directly.

ICOP Technology Inc.

Address: No. 15 Wugong 5th Road, Xinzhuang Dist.

New Taipei City, Taiwan (R.O.C.) 24890

TEL: +886-2-8990-1933

FAX: +886-2-8990-2045

Mail: info@icop.com.tw

Website: <http://www.icop.com.tw>

