



VERIFICATION OF COMPLIANCE

This Verification of Compliance is hereby issued to the product designated below.

Product	PC/104-Plus CPU Module
Model	PCM-3362; PCM-3362XXXXXXXXXXXXXX (X = 0 ~ 9 or A ~ Z or blank)
Trade name	ADVANTECH
Applicant	Advantech Co. Ltd. No.1, Alley 20, Lane 26, Rueiguang Road, Neihu District, Taipei 114, Taiwan, R.O.C.
Applicable Standard(s)	EN 55011: 2007 + A2: 2007 Group 1, Class A EN 55022: 2006 + A1: 2007, Class A EN 61000-6-4: 2007 EN 61000-3-2: 2006 EN 61000-3-3: 1995+ A1: 2001 + A2: 2005 EN 55024: 1998 + A1: 2001 + A2: 2003 EN 61000-6-2: 2005 IEC 61000-4-2: 1995+A1: 1998+A2: 2000 IEC 61000-4-3: 2006 IEC 61000-4-4: 2004 IEC 61000-4-5: 2005 IEC 61000-4-6: 2003 + A1: 2004 + A2: 2006 IEC 61000-4-8: 1993+A1: 2000 IEC 61000-4-11:2004
Report No.	91221101-E
Test Laboratory	Compliance Certification Services Inc. No. 81-1, Lane 210, Pa-De 2nd Rd., Luchu Hsiang, Taoyuan Shien, (338) Taiwan, R.O.C. Tel: +886-3-3240332/ Fax: +886-3-3245235

This device has been tested and found to comply with the stated standard(s), which is(are) required by the Council Directive of 2004/108/EC. The test results are indicated in the test report and are applicable only to the tested sample identified in the report.

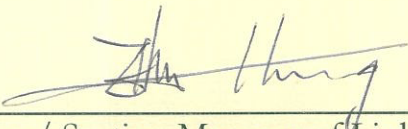
Ethan Huang / Section Manager of Linkou Laboratory
Date: December 29, 2009



Compliance Certification Services Inc.



CE EMC TEST REPORT

for

PC/104-Plus CPU Module

MODEL: PCM-3362; PCM-3362XXXXXXXXXXXX

(X = 0 ~ 9 or A ~ Z or blank)

Test Report Number:

91221101-E

Issued for

Advantech Co., Ltd.

No.1, Alley 20, Lane 26, Rueiguang Road, Neihu District, Taipei 114, Taiwan, R.O.C.

Issued By:

Compliance Certification Services Inc.

Linkuo Laboratory

No. 81-1, Lane 210, Pa-De 2nd Rd., Luchu Hsiang,
Taoyuan Shien, (338), Taiwan, R.O.C.

TEL: 886-3-324-0332

FAX: 886-3-324-5235

E-Mail: service@ccsrf.com

Issued Date: December 29, 2009



Note: This report shall not be reproduced except in full, without the written approval of Compliance Certification Services Inc. This document may be altered or revised by Compliance Certification Services Inc. personnel only, and shall be noted in the revision section of the document. The client should not use it to claim product endorsement by TAF, A2LA, NIST or any government agencies. The test results in the report only apply to the tested sample.



Revision History

Rev.	Issue Date	Revisions	Effect Page	Revised By
00	December 29, 2009	Initial Issue	ALL	Angel Hu



TABLE OF CONTENTS

1 TEST CERTIFICATION.....4
2 TEST RESULT SUMMARY.....5
3 EUT DESCRIPTION.....7
4 TEST METHODOLOGY.....8
4.1. DECISION OF FINAL TEST MODE.....8
4.2. EUT SYSTEM OPERATION.....8
5 SETUP OF EQUIPMENT UNDER TEST.....9
5.1. DESCRIPTION OF SUPPORT UNITS.....9
5.2. CONFIGURATION OF SYSTEM UNDER TEST.....9
6 FACILITIES AND ACCREDITATIONS.....10
6.1. FACILITIES.....10
6.2. ACCREDITATIONS.....10
6.3. MEASUREMENT UNCERTAINTY.....11
7 EMISSION TEST.....12
7.1. CONDUCTED EMISSION MEASUREMENT.....12
7.2. CONDUCTED EMISSION MEASUREMENT AT TELECOMMUNICATION PORTS.....17
7.3. RADIATED EMISSION MEASUREMENT.....23
7.4. HARMONICS CURRENT MEASUREMENT.....34
7.5. VOLTAGE FLUCTUATION AND FLICKS MEASUREMENT.....36
8 IMMUNITY TEST.....41
8.1. GENERAL DESCRIPTION.....41
8.2. GENERAL PERFORMANCE CRITERIA DESCRIPTION.....43
8.3. ELECTROSTATIC DISCHARGE (ESD).....44
8.4. RADIATED, RADIO-FREQUENCY, ELECTROMAGNETIC FIELD (RS).....50
8.5. ELECTRICAL FAST TRANSIENT (EFT).....54
8.6. SURGE IMMUNITY TEST.....57
8.7. CONDUCTED RADIO FREQUENCY DISTURBANCES (CS).....60
8.8. POWER FREQUENCY MAGNETIC FIELD.....64
8.9. VOLTAGE DIP & VOLTAGE INTERRUPTIONS.....67
9 PHOTOGRAPHS OF THE TEST CONFIGURATION.....70



1 TEST CERTIFICATION

Product:	PC/104-Plus CPU Module	
Model:	PCM-3362; PCM-3362XXXXXXXXXXXX (X = 0 ~ 9 or A ~ Z or blank)	
Brand:	ADVANTECH	
Applicant:	Advantech Co. Ltd. No.1, Alley 20, Lane 26, Rueiguang Road, Neihu District, Taipei 114, Taiwan, R.O.C.	
Manufacturer:	Advantech Co. Ltd. No.1, Alley 20, Lane 26, Rueiguang Road, Neihu District, Taipei 114, Taiwan, R.O.C.	
Tested:	December 21 ~ 25, 2009	
Test Voltage:	230VAC, 50Hz	
Applicable Standards:	EN 55011: 2007 + A2: 2007 Group 1, Class A EN 55022: 2006 +A1: 2007, Class A EN 61000-6-4: 2007 EN 61000-3-2: 2006, Class A EN 61000-3-3: 1995+ A1: 2001 + A2: 2005	EN 55024: 1998 + A1: 2001 + A2: 2003 EN 61000-6-2: 2005 IEC 61000-4-2: 1995+A1: 1998+A2: 2000 IEC 61000-4-3: 2006 IEC 61000-4-4: 2004 IEC 61000-4-5: 2005 IEC 61000-4-6: 2003 + A1: 2004 + A2: 2006 IEC 61000-4-8: 1993+A1: 2000 IEC 61000-4-11:2004

Deviation from Applicable Standard
According to applicant's declaration this EUT is a class A product, and to be market in industrial environment only.

The above equipment has been tested by Compliance Certification Services Inc., and found compliance with the requirements set forth in the technical standards mentioned above. The results of testing in this report apply only to the product/system, which was tested. Other similar equipment will not necessarily produce the same results due to production tolerance and measurement uncertainties.

Approved by:

Ethan Huang
Section Manager

Reviewed by:

Stan Lin
Supervisor



2 TEST RESULT SUMMARY

EMISSION [EN 55022: 2006 +A1: 2007; EN 61000-6-4: 2007; EN 55011: 2007 + A2: 2007 Group 1]			
Standard	Item	Result	Remarks
EN 55011: 2007 + A2: 2007 Group 1 EN 55022: 2006 +A1: 2007 EN 61000-6-4: 2007	Conducted (Main Port)	PASS	Meet Class A limit
	Conducted (Telecommunication port)	PASS	Meet Class B limit
	Radiated	PASS	Meet Class A limit
EN 61000-3-2: 2006	Harmonic current emissions	PASS	Meet Class A limit
EN 61000-3-3: 1995+ A1: 2001 + A2: 2005	Voltage fluctuations & flicker	PASS	Meets the requirements

IMMUNITY [EN 55024(1998 + A1: 2001 + A2: 2003)]			
Standard	Item	Result	Remarks
IEC 61000-4-2: 1995 + A1: 1998 + A2: 2000	ESD	PASS	Meets the requirements of Performance Criterion B
IEC 61000-4-3: 2006	RS	PASS	Meets the requirements of Performance Criterion A
IEC 61000-4-4: 2004	EFT	PASS	Meets the requirements of Performance Criterion B
IEC 61000-4-5: 2005	Surge	PASS	Meets the requirements of Performance Criterion B
IEC 61000-4-6: 2003 + A1: 2004 + A2: 2006	CS	PASS	Meets the requirements of Performance Criterion A
IEC 61000-4-8: 1993+A1: 2000	PFMF	PASS	Meets the requirements of Performance Criterion A
IEC 61000-4-11:2004	Voltage dips & voltage variations	PASS	Meets the requirements of Voltage Dips: 1) >95% reduction Performance Criterion B 2) 30% reduction Performance Criterion C Voltage Interruptions: 1) >95% reduction Performance Criterion C



IMMUNITY [EN 61000-6-2: 2005]			
Standard	Item	Result	Remarks
IEC 61000-4-2: 1995 + A1: 1998 + A2: 2000	ESD	PASS	Meets the requirements of Performance Criterion B
IEC 61000-4-3: 2006	RS	PASS	Meets the requirements of Performance Criterion A
IEC 61000-4-4: 2004	EFT	PASS	Meets the requirements of Performance Criterion B
IEC 61000-4-5: 2005	Surge	PASS	Meets the requirements of Performance Criterion B
IEC 61000-4-6: 2003 + A1: 2004 + A2: 2006	CS	PASS	Meets the requirements of Performance Criterion A
IEC 61000-4-8: 1993+A1: 2000	PFMF	PASS	Meets the requirements of Performance Criterion A
IEC 61000-4-11:2004	Voltage dips & voltage variations	PASS	Meets the requirements of Voltage Dips: 1) 0% reduction Performance Criterion B 2) 40% reduction Performance Criterion C 3) 70% reduction Performance Criterion C Voltage Interruptions: 1) 0% reduction Performance Criterion C

- Note:**
1. The statements of test result on the above are decided by the request of test standard only; the measurement uncertainties are not factored into this compliance determination.
 2. The information of measurement uncertainty is available upon the customer's request.



3 EUT DESCRIPTION

Product	PC/104-Plus CPU Module		
Model	PCM-3362; PCM-3362XXXXXXXXXXXXX (X = 0 ~ 9 or A ~ Z or blank)		
Brand	ADVANTECH		
Applicant	Advantech Co. Ltd.		
Serial Number	91221101		
Received Date	December 21, 2009		
EUT Power Rating	VDC from Switching Power Supply		
Switching Power Supply	FSP	Model	FSP180-50PLA
Power Supply Power Rating	I/P: 100-240VAC, 4.2A, 50-60Hz O/P: 3.3Vdc, 16.8A; +5Vsb, 2.0A; -12Vdc, 0.8A; +5, 12A		
CPU Manufacturer	Intel	Model	1.66GHz
Memory Capacity	N/A	Installed	1.00GB
FDD Manufacturer	NTFS	Model	1.91GB
LAN Card Manufacturer	Intel	Model	82567V-3
Sound Card Manufacturer	Apacer	Model	PC2-5300CL5

I/O PORT

I/O PORT TYPES	Q'TY	TESTED WITH
1). PS/2 Keyboard Port	1	1
2). Serial Port	2	2
3). USB Port	4	4
4). LAN Port	1	1
5). D-Sub Port	1	1

Note: 1. The mean of "X (X= 0~9, A~Z or Blank)" on model number, they are identical just for marketing purpose only.
 2. Client consigns only one sample to test (model number: PCM-3362). Therefore, the testing Lab. just guarantees the unit, which has been tested.



4 TEST METHODOLOGY

4.1. DECISION OF FINAL TEST MODE

1. The following test mode(s) were scanned during the preliminary test:

Pre-Test Mode
Mode 1: D-SUB 1680 x 1050 / 60Hz (Close Case)
Mode 2: D-SUB 1400 x 1050 / 60Hz (Close Case)
Mode 3: D-SUB 640 x 480 / 75Hz (Close Case)
Mode 4: D-SUB 1680 x 1050 / 60Hz (Open Case)

2. After the preliminary scan, the following test mode was found to produce the highest emission level.

Final Test Mode		
Emission	Conducted Emission	Mode 1
	Radiated Emission	Mode 1, 4
Immunity		Mode 1

Then, the above highest emission mode of the configuration of the EUT and cable was chosen for all final test items.

4.2. EUT SYSTEM OPERATION

1	Setup the EUT and simulators as shown on 5.2.
2	Turn on the power of all equipment.
3	Personal Computer (EUT) reads data from disk.
4	EUT will sends “H” pattern to monitor, the monitor will show “H” pattern on the screen.
5	EUT reads and writes data into and from modem.
6	EUT will read data from floppy disk and then writes the data into floppy disk, same operation for hard disk.
7	EUT Connect another simulation Notebook PC through LAN port and carry out Read/Write work each other.
8	Repeat the above procedure (3) to (7).

Note: Test program is self-repeating throughout the test.

5 SETUP OF EQUIPMENT UNDER TEST

5.1. DESCRIPTION OF SUPPORT UNITS

The EUT has been tested as an independent unit together with other necessary accessories or support units. The following support units or accessories were used to form a representative test configuration during the tests.

No.	Equipment	Model No.	Serial No.	FCC ID	Trade Name	Data Cable	Power Cord
1	Monitor	959NF	AQ19H2RT706126P	FCC DoC	SAMSUNG	D-SUB Cable: Shielded, 1.8m	Unshielded, 1.8m
2	Modem	DM-1414	304012261	IFAXDM1414	ACEEX	Unshielded, 1.8m	Unshielded, 1.8m
3	Modem	DM-1414	304012262	IFAXDM1414	ACEEX	Unshielded, 1.8m	Unshielded, 1.8m
4	USB 2.0 External HDD	F12-U	A0100214-43b0001	FCC DoC	TeraSys	Shielded, 1.8m	N/A
5	USB 2.0 External HDD	F12-U	A0100214-43b0005	FCC DoC	TeraSys	Shielded, 1.8m	N/A
6	USB 2.0 External HDD	F12-U	A0100214-43b0001	FCC DoC	TeraSys	Shielded, 1.8m	N/A
7	USB 2.0 External HDD	F12-U	A0100214-43b0005	FCC DoC	TeraSys	Shielded, 1.8m	N/A
8	PS/2 Keyboard	Y-SJ17	SY520U00643	FCC DoC	Logitech	Unshielded, 1.8m	N/A
9	PS/2 Mouse	M-CAA43	LZE03257032	FCC DoC	Logitech	Unshielded, 1.8m	N/A
10	Notebook PC (Remote)	COMPAQ NC 4010	CNU441F8LV	FCC DoC	HP	LAN Cable: Unshielded, 12m	AC I/P: Unshielded, 1.8m DC O/P: Unshielded, 1.8m with a core

Note: Grounding was established in accordance with the manufacturer's requirements and conditions for the intended use.

5.2. CONFIGURATION OF SYSTEM UNDER TEST

1. Monitor	2. Modem	3. Modem
4. USB 2.0 External HDD	5. USB 2.0 External HDD	6. USB 2.0 External HDD
7. USB 2.0 External HDD	8. PS/2 Keyboard	9. PS/2 Mouse
10. Notebook PC	---	---

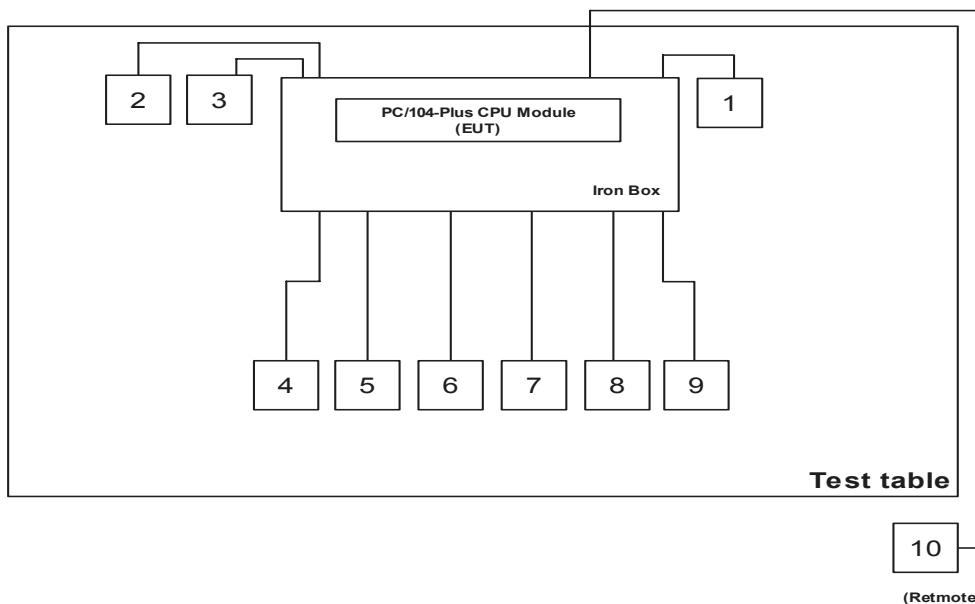



6 FACILITIES AND ACCREDITATIONS

6.1. FACILITIES

All measurement facilities used to collect the measurement data are located at No. 81-1, Lane 210, Pa-De 2nd Rd., Luchu Hsiang, Taoyuan Shien, Taiwan.

The sites are constructed in conformance with the requirements of ANSI C63.4 and CISPR 22. All receiving equipment conforms to CISPR 16-1-1, CISPR 16-1-2, CISPR 16-1-3, CISPR 16-1-4, CISPR 16-1-5.

6.2. ACCREDITATIONS

Our laboratories are accredited and approved by the following approval agencies according to ISO/IEC 17025.

Taiwan	TAF
USA	A2LA

The measuring facility of laboratories has been authorized or registered by the following approval agencies.

Canada	Industry Canada
Germany	TUV Rheinland
Japan	VCCI
Taiwan	BSMI
USA	FCC

Copies of granted accreditation certificates are available for downloading from our web site, <http://www.ccsrf.com>

6.3. MEASUREMENT UNCERTAINTY

Where relevant, the following measurement uncertainty levels have been estimated for tests performed on the EUT as specified in CISPR 16-4-2:

Measurement	Frequency	Uncertainty
Conducted emissions	9kHz~30MHz	±1.7806
Radiated emissions	30~200MHz	±3.8906
	200~1000MHz	±3.8688

This uncertainty represents an expanded uncertainty expressed at approximately the 95% confidence level using a coverage factor of $k=2$.

Consistent with industry standard (e.g. CISPR 22: 2006, clause 11, Measurement Uncertainty) determining compliance with the limits shall be base on the results of the compliance measurement. Consequently the measure emissions being less than the maximum allowed emission result in this be a compliant test or passing test.

The acceptable measurement uncertainty value without requiring revision of the compliance statement is base on conducted and radiated emissions being less than U_{CISPR} which is 3.6dB and 5.2dB respectively. CCS values (called U_{Lab} in CISPR 16-4-2) is less than U_{CISPR} as shown in the table above. Therefore, MU need not be considered for compliance.



7 EMISSION TEST

7.1. CONDUCTED EMISSION MEASUREMENT

7.1.1. LIMITS

FREQUENCY (MHz)	Class A (dBuV)		Class B (dBuV)	
	Quasi-peak	Average	Quasi-peak	Average
0.15 - 0.5	79	66	66 - 56	56 - 46
0.50 - 5.0	73	60	56	46
5.0 - 30.0	73	60	60	50

NOTE:

- (1) The lower limit shall apply at the transition frequencies.
- (2) The limit decreases in line with the logarithm of the frequency in the range 0.15 to 0.50 MHz.
- (3) All emanations from a class A/B digital device or system, including any network of conductors and apparatus connected thereto, shall not exceed the level of field strengths specified above.

7.1.2. TEST INSTRUMENTS

Conducted Emission Room # 3				
Name of Equipment	Manufacturer	Model	Serial Number	Calibration Due
EMI Test Receiver	R&S	ESCS30	845552/030	05/18/2010
LISN	R&S	ENV216	100074	12/09/2010
LISN	FCC	FCC-LISN-50/250-16-2-07	06013	10/12/2010
Test S/W	CCS-3A1-CE			

- NOTE:** 1. The calibration interval of the above test instruments is 12 months and the calibrations are traceable to NML/ROC and NIST/USA.
 2. N.C.R = No Calibration Request.



7.1.3. TEST PROCEDURES (please refer to measurement standard or CCS SOP PA-031)

Procedure of Preliminary Test

- The EUT and support equipment, if needed, were set up as per the test configuration to simulate typical usage per the user's manual. When the EUT is a tabletop system, a wooden table with a height of 0.8 meters is used and is placed on the ground plane as per EN 55022 (see Test Facility for the dimensions of the ground plane used). When the EUT is a floor standing equipment, it is placed on the ground plane, which has a 3-12 mm non-conductive covering to insulate the EUT from the ground plane.
- All I/O cables were positioned to simulate typical actual usage as per EN 55022.
- The EUT installed by AC main power, through a Line Impedance Stabilization Network (LISN), which was supplied power source and was grounded to the ground plane.
- All support equipment power by a second LISN.
- The test program of the EUT was started. Emissions were measured on each current carrying line of the EUT using an EMI Test Receiver connected to the LISN powering the EUT.
- The Receiver scanned from 150kHz to 30MHz for emissions in each of the test modes.
- During the above scans, the emissions were maximized by cable manipulation.
- The test mode(s) described in Item 3.1 were scanned during the preliminary test.
- After the preliminary scan, we found the test mode described in Item 3.1 producing the highest emission level.
- The worst configuration of EUT and cable of the above highest emission level were recorded for reference of the final test.

Procedure of Final Test

- EUT and support equipment were set up on the test bench as per the configuration with highest emission level in the preliminary test.
- A scan was taken on both power lines, Line 1 and Line 2, recording at least the six highest emissions. Emission frequency and amplitude were recorded into a computer in which correction factors were used to calculate the emission level and compare reading to the applicable limit.
- The test data of the worst-case condition(s) was recorded.

7.1.4. TEST SETUP

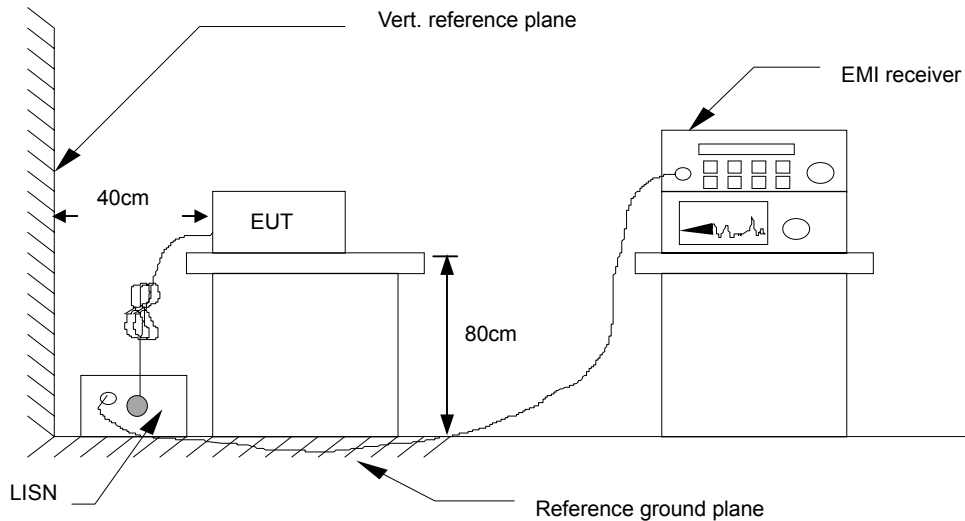

- For the actual test configuration, please refer to the related item – Photographs of the Test Configuration.

7.1.5. DATA SAMPLE:

Frequency (MHz)	QuasiPeak reading (dBuV)	Average reading (dBuV)	Correctrion factor (dB)	QuasiPeak result (dBuV)	Average result (dBuV)	QuasiPeak. limit (dBuV)	Average limit (dBuV)	QuasiPeak margin (dB)	Average margin (dB)	Remark
x.xx	38.01	13.22	9.65	47.66	22.87	79.00	66.00	-31.34	-43.13	Pass

Frequency (MHz) = Emission frequency in MHz
 Reading (dBuV) = Uncorrected Analyzer/Receiver reading + Insertion loss of LISN, if it > 0.5 dB
 Correction Factor (dB) = LISN Factor + Cable loss
 Result (dBuV) = Raw reading converted to dBuV and CF added
 Limit (dBuV) = Limit stated in standard
 Margin (dB) = Result (dBuV) – Limit (dBuV)



7.1.6. TEST RESULTS

CCS Conduction Test 3

Model No.	PCM-3362	6dB Bandwidth	9 kHz
Environmental Conditions	25°C, 57% RH	Test Mode	Mode 1
Tested By	Tony Tsai	Line	L1

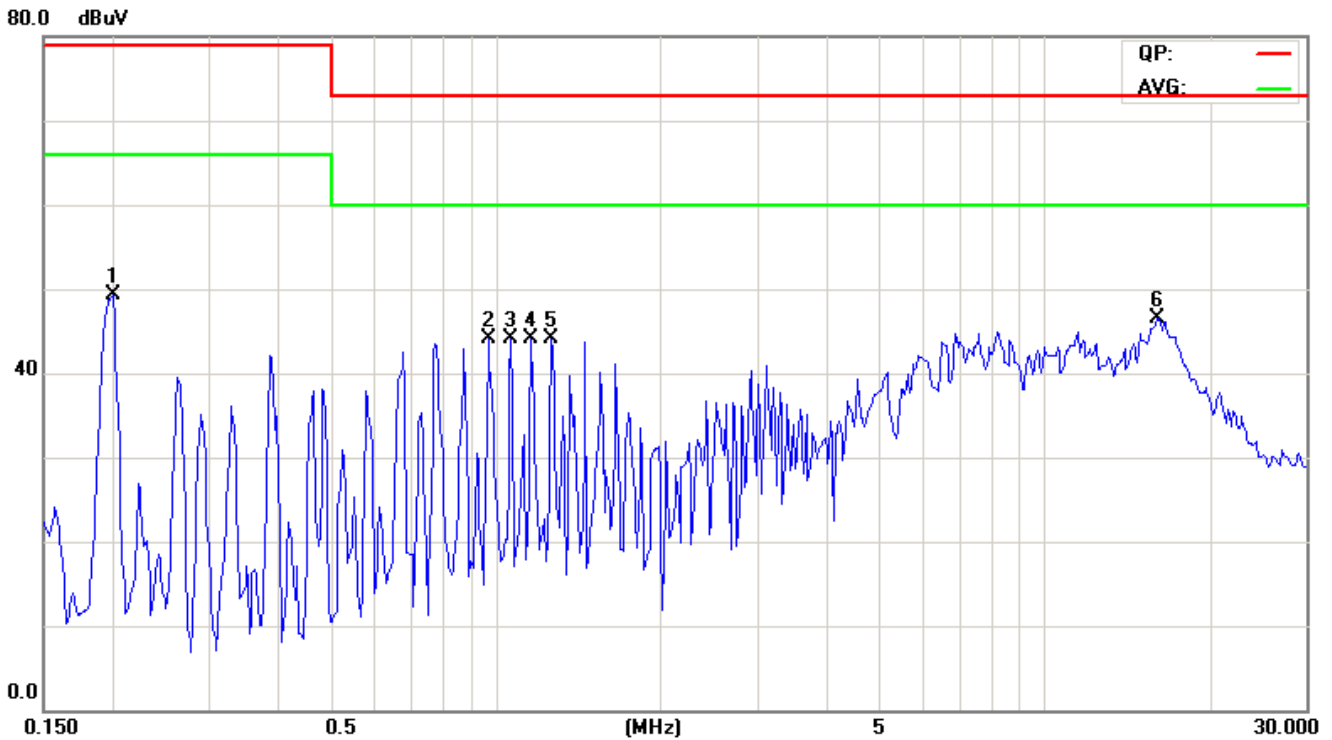

NO.	Frequency (MHz)	QuasiPeak	Average	Correction factor (dB)	QuasiPeak	Average	QuasiPeak	Average	QuasiPeak	Average	Remark (Pass/Fail)
		reading (dBuV)	reading (dBuV)		result (dBuV)	result (dBuV)					
1	0.2008	47.76	43.06	0.14	47.90	43.20	79.00	66.00	-31.10	-22.80	Pass
2*	0.9703	43.30	38.10	0.00	43.30	38.10	73.00	60.00	-29.70	-21.90	Pass
3	1.0680	43.59	37.79	0.01	43.60	37.80	73.00	60.00	-29.40	-22.20	Pass
4	1.1656	43.58	37.58	0.02	43.60	37.60	73.00	60.00	-29.40	-22.40	Pass
5	1.2672	39.87	33.57	0.03	39.90	33.60	73.00	60.00	-33.10	-26.40	Pass
6	16.0953	42.87	32.77	0.73	43.60	33.50	73.00	60.00	-29.40	-26.50	Pass

REMARKS: L1 = Line One (Live Line)



CCS Conduction Test 3

Model No.	PCM-3362	6dB Bandwidth	9 kHz
Environmental Conditions	25°C, 57% RH	Test Mode	Mode 1
Tested By	Tony Tsai	Line	L2

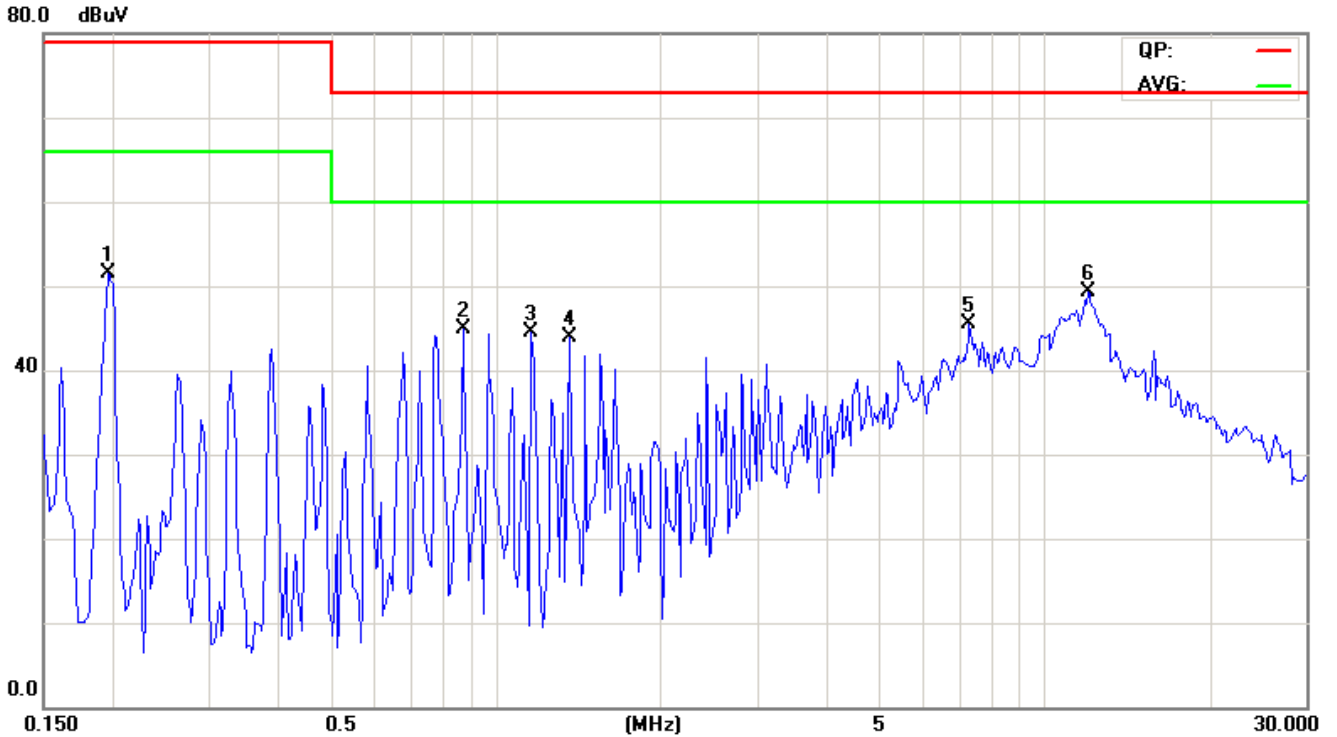

NO.	Frequency	QuasiPeak		Correction factor	Average		QuasiPeak		Average		Remark
		reading	limit		reading	limit	margin	margin			
1*	0.1969	50.20	79.00	0.10	44.80	66.00	50.30	73.00	-28.70	-21.10	Pass
2	0.8727	43.40	73.00	0.00	37.80	60.00	43.40	73.00	-29.60	-22.20	Pass
3	1.1656	44.08	73.00	0.02	37.98	60.00	44.10	73.00	-28.90	-22.00	Pass
4	1.3609	43.26	73.00	0.04	36.96	60.00	43.30	73.00	-29.70	-23.00	Pass
5	7.2906	41.74	73.00	0.26	35.94	60.00	42.00	73.00	-31.00	-23.80	Pass
6	12.0563	45.97	73.00	0.63	36.17	60.00	46.60	73.00	-26.40	-23.20	Pass

REMARKS: L2 = Line Two (Neutral Line)



7.2. CONDUCTED EMISSION MEASUREMENT AT TELECOMMUNICATION PORTS

7.2.1. LIMITS

For Class A Equipment

FREQUENCY (MHz)	Voltage Limit (dBuV)		Current Limit (dBuA)	
	Quasi-peak	Average	Quasi-peak	Average
0.15 ~ 0.5	97 ~ 87	84 ~ 74	53 ~ 43	40 ~ 30
0.5 ~ 30.0	87	74	43	30

For Class B Equipment

FREQUENCY (MHz)	Voltage Limit (dBuV)		Current Limit (dBuA)	
	Quasi-peak	Average	Quasi-peak	Average
0.15 - 0.5	84 ~ 74	74 ~ 64	40 ~ 30	30 ~ 20
0.5 - 30.0	74	64	30	20

NOTE: The limits decrease linearly with the logarithm of the frequency in the range 0.15 MHz to 0.5 MHz.

7.2.2. TEST INSTRUMENTS

Conducted Emission Room #3				
Name of Equipment	Manufacturer	Model	Serial Number	Calibration Due
EMI Test Receiver	R&S	ESCS30	845552/030	05/18/2010
LISN	R&S	ENV216	100074	12/09/2010
LISN	FCC	FCC-LISN-50/250 -16-2-07	06013	10/13/2010
ISN	FCC	FCC-TLISN-T2-02	20587	06/21/2010
ISN	FCC	FCC-TLISN-T8-02	20148	04/06/2010
Test S/W	CCS-3A1-CE			

NOTE: 1. The calibration interval of the above test instruments is 12 months and the calibrations are traceable to NML/ROC and NIST/USA.

2. N.C.R = No Calibration Request.



7.2.3. TEST PROCEDURE (please refer to measurement standard or CCS SOP PA-031)

- Selecting ISN for unscreened cable or a current probe for screened cable to take measurement.
- The port of the EUT was connected to the remote side support equipment through the ISN/Current Probe and communication in normal condition.
- Making a overall range scan by using the test receiver controlled by controller and record at least six highest emissions for showing in the test report.
- Emission frequency and amplitude were recorded into a computer in which correction factors were used to calculate the emission level and compare reading to the applicable limit.
- In case of measuring on the screened cable, the current limit shall be applied; otherwise the voltage limit should be applied.
- The following test mode was scanned during the preliminary test:
Mode 1: 10/100 Mbps and 1Gbps (Emission mode 1)
- After the preliminary scan, we found the following test mode(s) producing the highest emission level and test data of the worst case was recorded.

Mode 1

7.2.4. TEST SETUP

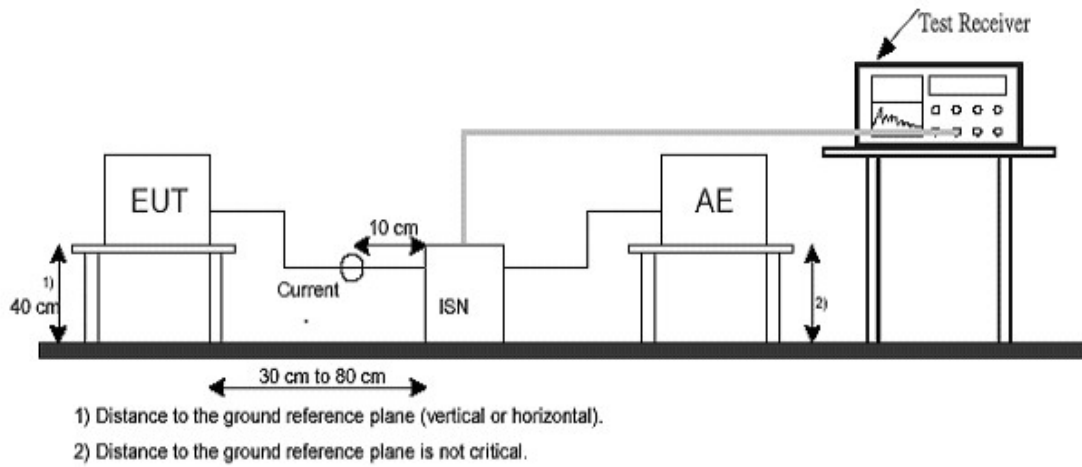

- For the actual test configuration, please refer to the related item – Photographs of the Test Configuration.

7.2.5. DATA SAMPLE:

Frequency (MHz)	QuasiPeak reading (dBuV)	Average reading (dBuV)	Correctrion factor (dB)	QuasiPeak result (dBuV)	Average result (dBuV)	QuasiPeak. limit (dBuV)	Average limit (dBuV)	QuasiPeak margin (dB)	Average margin (dB)	Remark
x.xx	32.24	16.42	9.99	42.23	26.41	87.00	74.00	-44.77	-47.59	Pass

Frequency (MHz) = Emission frequency in MHz
 Reading (dBuV) = Uncorrected Analyzer/Receiver reading + Insertion loss of LISN, if it > 0.5 dB
 Correction Factor (dB) = ISN Factor + Cable loss
 Result (dBuV) = Raw reading converted to dBuV and CF added
 Limit (dBuV) = Limit stated in standard
 Margin (dB) = Result (dBuV) – Limit (dBuV)



7.2.6. TEST RESULTS

CCS Conduction Test 3

Model No.	PCM-3362	6dB Bandwidth	9 kHz
Environmental Conditions	25°C, 57% RH	Test Mode	Mode 1
Tested by	Tony Tsai	Line	10Mbps

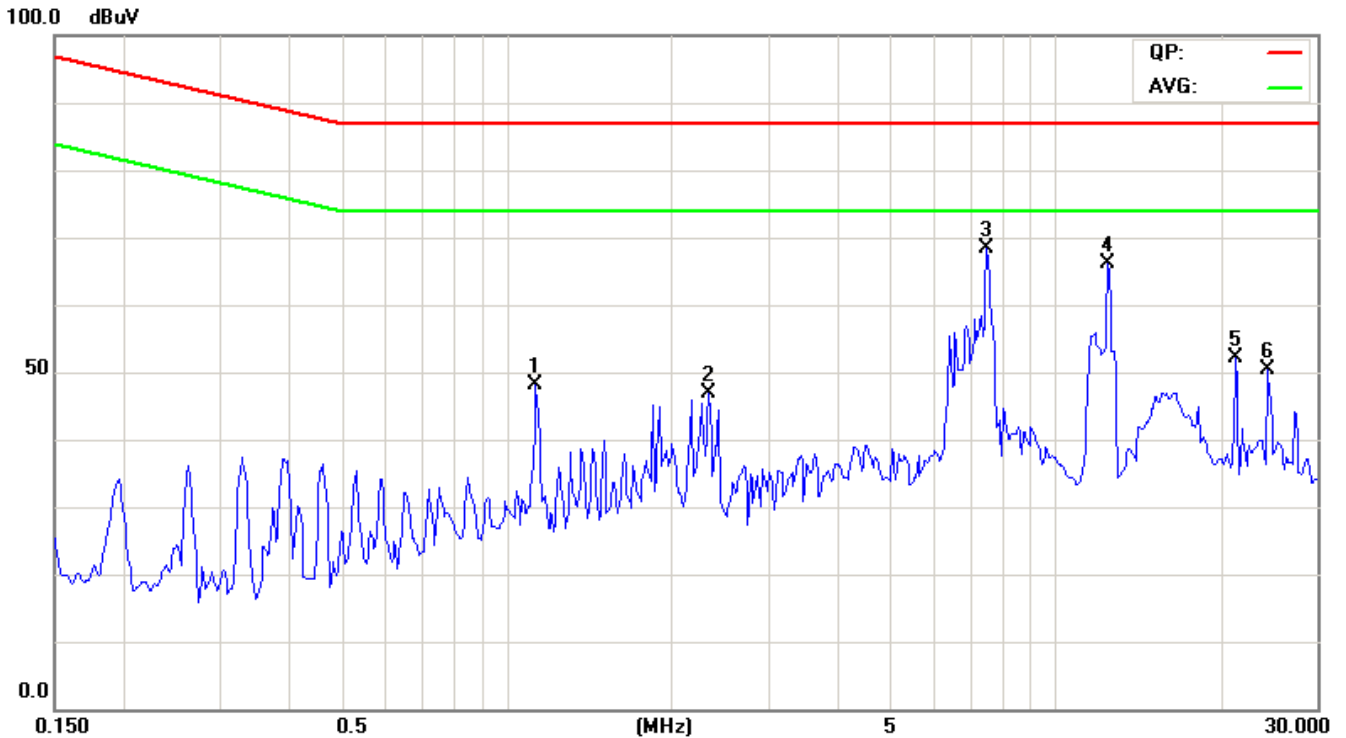

NO.	Frequency (MHz)	QuasiPeak reading (dBuV)	Average reading (dBuV)	Correction factor (dB)	QuasiPeak result (dBuV)	Average result (dBuV)	QuasiPeak limit (dBuV)	Average limit (dBuV)	QuasiPeak margin (dB)	Average margin (dB)	Remark
1	1.1344	37.87	37.47	9.83	47.70	47.30	87.00	74.00	-39.30	-26.70	Pass
2	2.3375	29.27	15.97	9.93	39.20	25.90	87.00	74.00	-47.80	-48.10	Pass
3	7.4977	52.27	40.47	10.03	62.30	50.50	87.00	74.00	-24.70	-23.50	Pass
4	12.5016	47.69	35.69	10.31	58.00	46.00	87.00	74.00	-29.00	-28.00	Pass
5*	21.3023	41.33	41.13	10.47	51.80	51.60	87.00	74.00	-35.20	-22.40	Pass
6	24.3453	40.32	39.02	10.58	50.90	49.60	87.00	74.00	-36.10	-24.40	Pass



CCS Conduction Test 3

Model No.	PCM-3362	6dB Bandwidth	9 kHz
Environmental Conditions	25°C, 57% RH	Test Mode	Mode 1
Tested by	Tony Tsai	Line	100Mbps

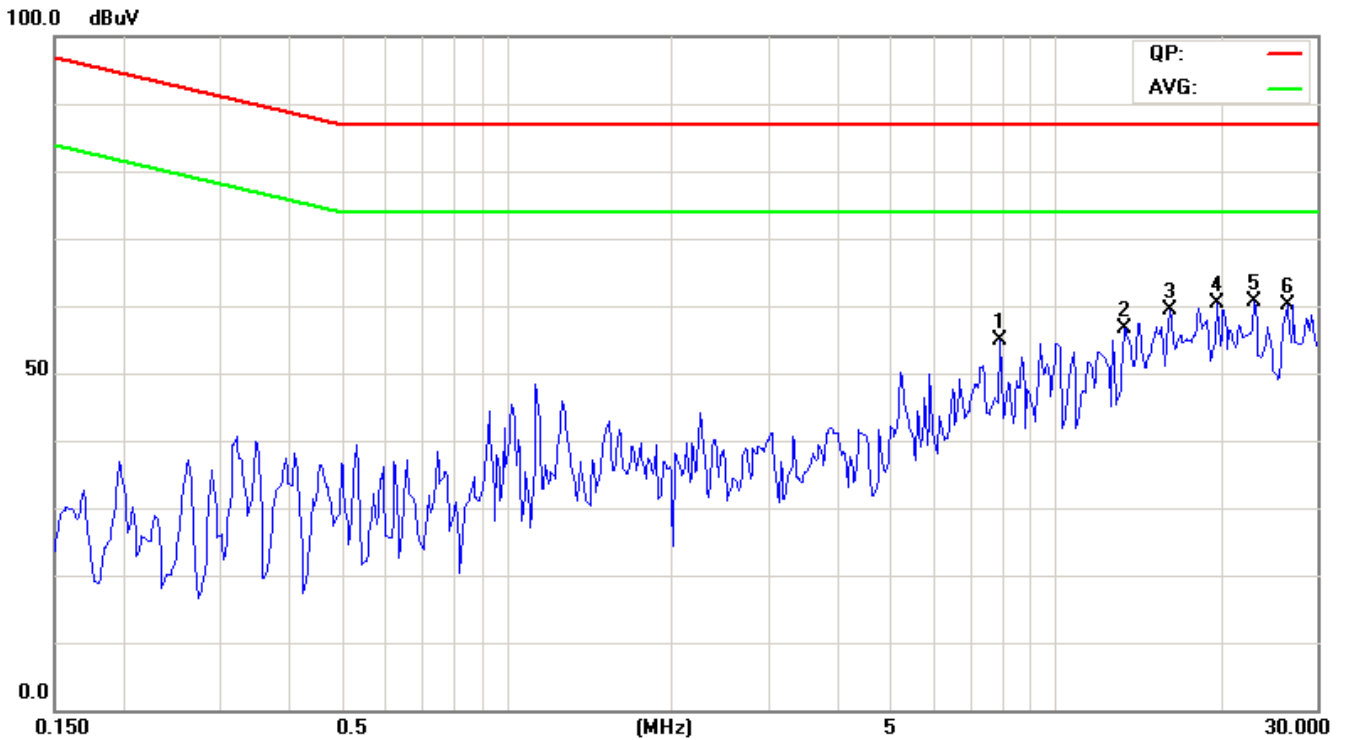

NO.	Frequency (MHz)	QuasiPeak reading (dBuV)	Average reading (dBuV)	Correction factor (dB)	QuasiPeak result (dBuV)	Average result (dBuV)	QuasiPeak limit (dBuV)	Average limit (dBuV)	QuasiPeak margin (dB)	Average margin (dB)	Remark (Pass/Fail)
1	7.9234	44.93	42.03	10.07	55.00	52.10	87.00	74.00	-32.00	-21.90	Pass
2	13.3570	45.97	42.77	10.33	56.30	53.10	87.00	74.00	-30.70	-20.90	Pass
3	16.1656	48.74	45.54	10.36	59.10	55.90	87.00	74.00	-27.90	-18.10	Pass
4	19.7086	49.89	46.59	10.41	60.30	57.00	87.00	74.00	-26.70	-17.00	Pass
5	23.1266	49.86	46.56	10.54	60.40	57.10	87.00	74.00	-26.60	-16.90	Pass
6*	26.4859	49.20	46.60	10.60	59.80	57.20	87.00	74.00	-27.20	-16.80	Pass



CCS Conduction Test 3

Model No.	PCM-3362	6dB Bandwidth	9 kHz
Environmental Conditions	25°C, 57% RH	Test Mode	Mode 1
Tested by	Tony Tsai	Line	1Gbps

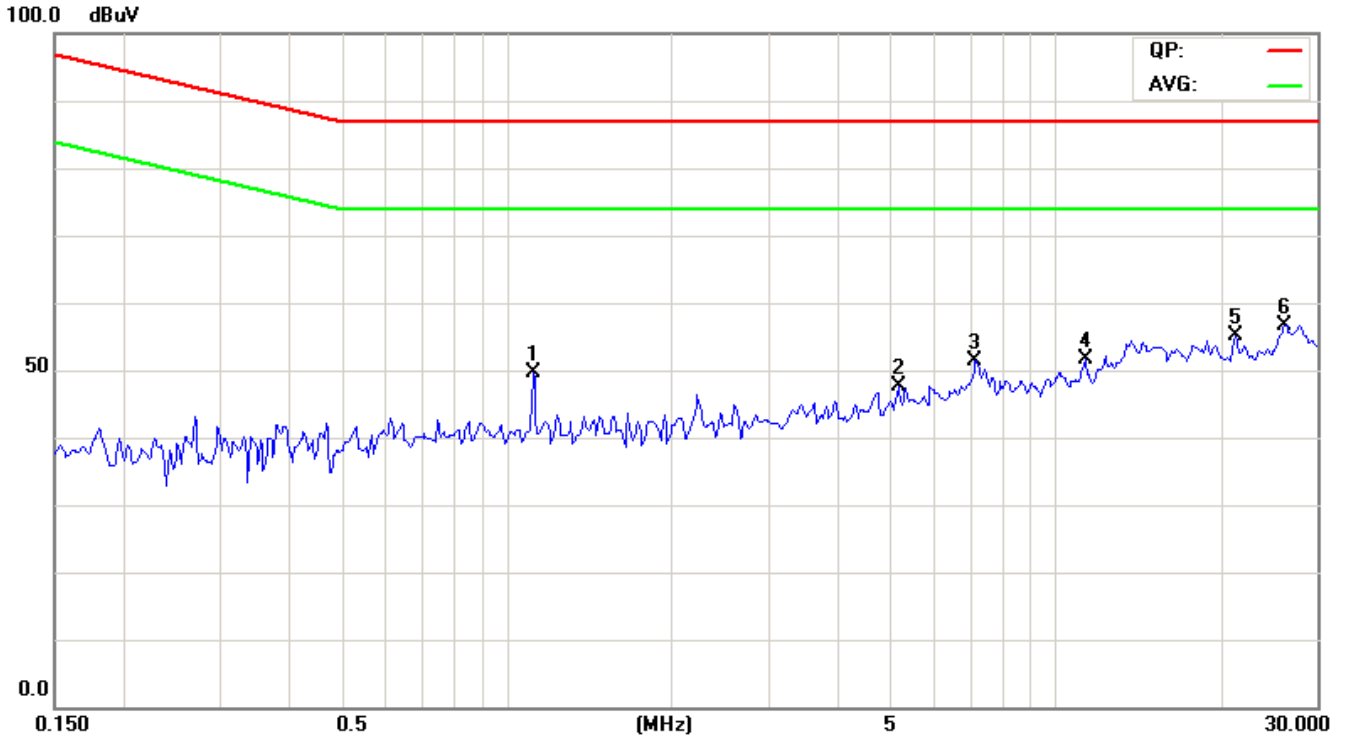

NO.	Frequency (MHz)	QuasiPeak reading (dBuV)	Average reading (dBuV)	Correction factor (dB)	QuasiPeak result (dBuV)	Average result (dBuV)	QuasiPeak limit (dBuV)	Average limit (dBuV)	QuasiPeak margin (dB)	Average margin (dB)	Remark
1	1.1227	36.87	32.37	9.83	46.70	42.20	87.00	74.00	-40.30	-31.80	Pass
2	5.1695	32.81	26.91	9.99	42.80	36.90	87.00	74.00	-44.20	-37.10	Pass
3	7.1656	36.00	29.90	10.00	46.00	39.90	87.00	74.00	-41.00	-34.10	Pass
4	11.3727	35.41	29.71	10.29	45.70	40.00	87.00	74.00	-41.30	-34.00	Pass
5*	21.3023	44.13	41.33	10.47	54.60	51.80	87.00	74.00	-32.40	-22.20	Pass
6	26.2633	41.40	35.70	10.60	52.00	46.30	87.00	74.00	-35.00	-27.70	Pass

7.3. RADIATED EMISSION MEASUREMENT

7.3.1. LIMITS

FREQUENCY (MHz)	dBuV/m (At 10m)	
	Class A	Class B
30 ~ 230	40	30
230 ~ 1000	47	37

NOTE: 1. The lower limit shall apply at the transition frequencies.
 2. Emission level (dBuV/m) = 20 log Emission level (uV/m).

FREQUENCY (MHz)	dBuV/m (At 3m)			
	Class A		Class B	
	Average	Peak	Average	Peak
1000 ~ 3000	56	76	50	70
3000 ~ 6000	60	80	54	74

NOTE: (1) The lower limit shall apply at the transition frequencies.

According to EN55022: 2006 + A1: 2007 clause 6.2, the measurement frequency range shown in the following table:

Highest frequency generated or used within the EUT or on which the EUT operates or tunes (MHz)	Upper frequency of measurement range (MHz)
Less than 108	1000
108-500	2000
500-1000	5000
Above 1000	5 times of the highest frequency or 6GHz, whichever is less



7.3.2. TEST INSTRUMENTS

Open Area Test Site # 5				
Name of Equipment	Manufacturer	Model	Serial Number	Calibration Due
Spectrum Analyzer	ADVANTEST	R3261C	81720301	N.C.R
EMI Test Receiver	R&S	ESVS20	838804/004	03/11/2010
Pre-Amplifier	HP	8447D	2944A09173	04/14/2010
Bilog Antenna	TESEQ	CBL 6112D	23189	06/19/2010
Turn Table	CCS	CC-T-1F	N/A	N.C.R
Antenna Tower	CCS	CC-A-1F	N/A	N.C.R
Controller	CCS	CC-C-1F	N/A	N.C.R
RF Switch	Anritsu	MP59B	M54367	N.C.R
Site NSA	CCS	N/A	N/A	03/06/2010
Test S/W	LabVIEW 6.1 (CCS OATS EMI SW V2.7)			

3 Meter Chamber				
Name of Equipment	Manufacturer	Model	Serial Number	Calibration Due
Spectrum Analyzer	Agilent	E4446A	MY48250064	10/28/2010
Pre-Amplifier	HP	8449B	3008A00965	12/31/2010
Pre-Amplifier	MITEQ	AMF-6F-260400-4 0-8P	985646	05/24/2010
Horn Antenna	EMCO	3115	9602-4659	04/16/2010
Horn Antenna	EMCO	3116	00026370	10/15/2010
Low Loss Cable	Huber+Suhner	104PEA	24813/4PEA	04/17/2010
Low Loss Cable	Huber+Suhner	104PEA	30956/4PEA	04/17/2010
Site VSWR	SIDT EUROPE	9x6x6	N/A	02/27/2010
Turn Table	CCS	CC-T-1F	N/A	N.C.R
Antenna Tower	CCS	CC-A-1F	N/A	N.C.R
Controller	CCS	CC-C-1F	N/A	N.C.R
Test S/W	CCS-3A1RE			

NOTE: 1. The calibration interval of the above test instruments is 12 months and the calibrations are traceable to NML/ROC and NIST/USA.
 2. N.C.R = No Calibration Request.

7.3.3. TEST PROCEDURE (please refer to measurement standard or CCS SOP PA-031)**Procedure of Preliminary Test**

- The equipment was set up as per the test configuration to simulate typical usage per the user's manual. When the EUT is a tabletop system, a wooden turntable with a height of 0.8 meters is used which is placed on the ground plane. When the EUT is a floor standing equipment, it is placed on the ground plane which has a 3-12 mm non-conductive covering to insulate the EUT from the ground plane.
- Support equipment, if needed, was placed as per EN 55022.
- All I/O cables were positioned to simulate typical usage as per EN 55022.
- The EUT received AC power source from the outlet socket under the turntable. All support equipment power received from another socket under the turntable.
- The antenna was placed at 3 or 10 meter away from the EUT as stated in EN 55022. The antenna connected to the Spectrum Analyzer via a cable and at times a pre-amplifier would be used.
- The Analyzer / Receiver quickly scanned from 30MHz to 6000MHz. The EUT test program was started. Emissions were scanned and measured rotating the EUT to 360 degrees and positioning the antenna 1 to 4 meters above the ground plane, in both the vertical and the horizontal polarization, to maximize the emission reading level.
- The test mode(s) described in Item 3.1 were scanned during the preliminary test:
- After the preliminary scan, we found the test mode described in Item 3.1 producing the highest emission level.
- The worst configuration of EUT and cable, antenna position, polarization and turntable position of the above highest emission levels were recorded for the final test.

Procedure of Final Test

- EUT and support equipment were set up on the turntable as per the configuration with highest emission level in the preliminary test.
- The Analyzer / Receiver scanned from 30MHz to 6000MHz. Emissions were scanned and measured rotating the EUT to 360 degrees, varying cable placement and positioning the antenna 1 to 4 meters above the ground plane, in both the vertical and the horizontal polarization, to maximize the emission reading level.
- Recording at least the six highest emissions. Emission frequency, amplitude, antenna position, polarization and turntable position were recorded into a computer in which correction factors were used to calculate the emission level and compare reading to the applicable limit and only Q.P. reading is presented.
- The test data of the worst-case condition(s) was recorded.

7.3.4. TEST SETUP

30 ~ 1000MHz

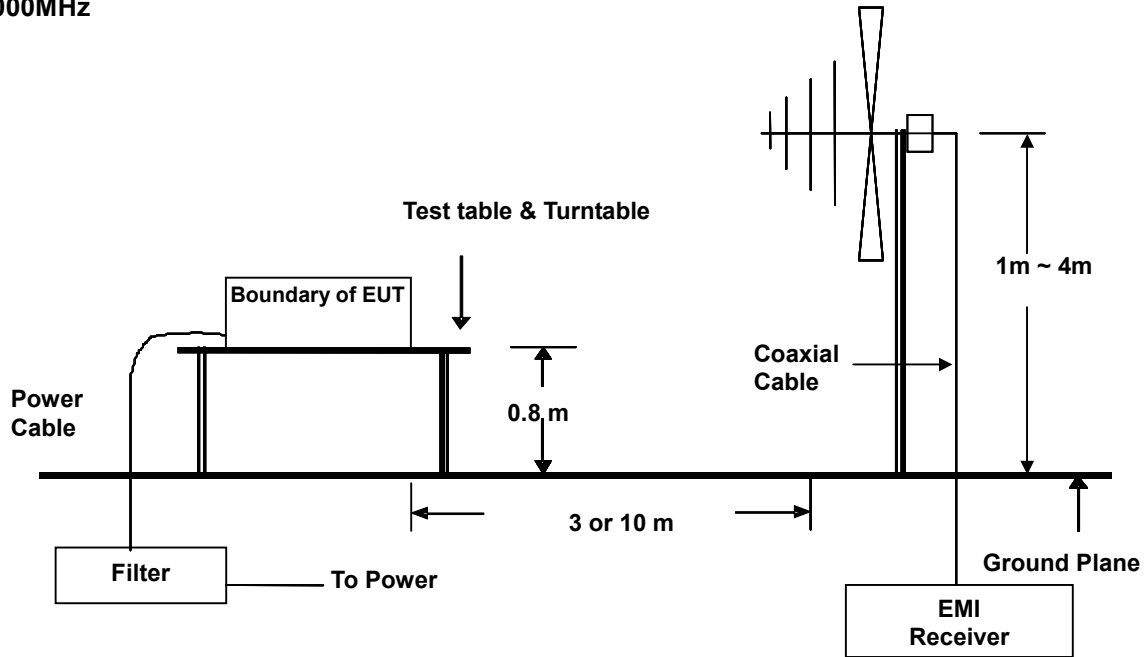

1000 ~ 6000MHz

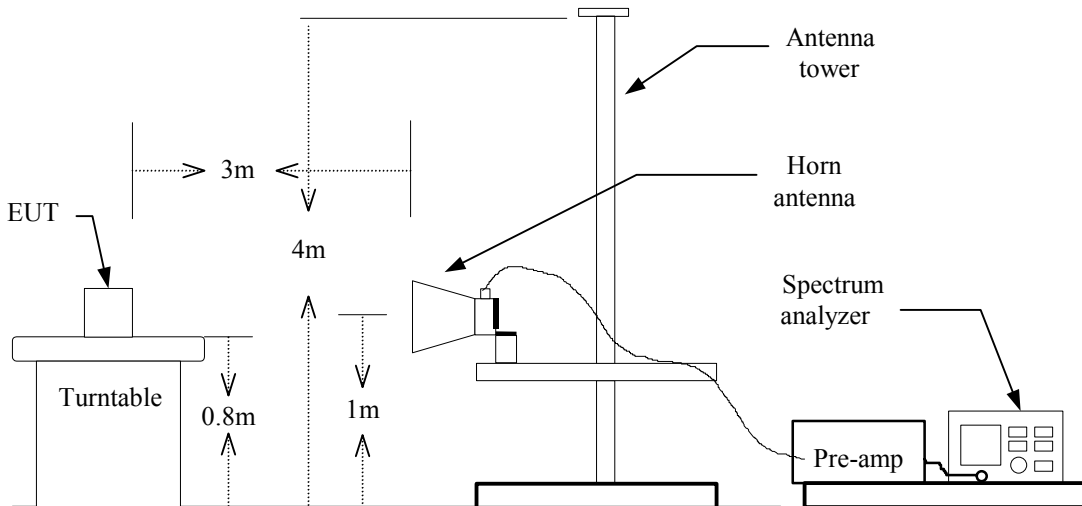

- For the actual test configuration, please refer to the related item – Photographs of the Test Configuration.



7.3.5. DATA SAMPLE:

Below 1GHz

Frequency (MHz)	Reading (dBuV)	Correction Factor (dB/m)	Result (dBuV/m)	Limit (dBuV/m)	Margin (dB)	Degree (°)	Height (cm)	Remark
xx.xx	16.49	9.86	26.35	40.00	-13.65	116.00	101.00	QP

Above 1GHz

Frequency MHz	Corr. Factor (dB/m)	Reading		Result		Limit		Margin	
		Average (dBuV/m)	Peak (dBuV/m)	Average (dBuV/m)	Peak (dBuV/m)	Average (dBuV/m)	Peak (dBuV/m)	Average (dB)	Peak (dB)
xxxx.xxx	-4.35	49.81	58.74	45.46	54.39	56.00	76.00	-10.54	-21.61

- Frequency (MHz) = Emission frequency in MHz
- Reading (dBuV) = Uncorrected Analyzer / Receiver reading
- Correction Factor (dB/m) = Antenna factor + Cable loss – Amplifier gain
- Result (dBuV/m) = Reading (dBuV) + Corr. Factor (dB/m)
- Limit (dBuV/m) = Limit stated in standard
- Margin (dB) = Result (dBuV/m) – Limit (dBuV/m)
- Q.P. = Quasi-Peak

7.3.6. TEST RESULTS

Below 1GHz

Model No.	PCM-3362	Test Mode	Mode 1
Environmental Conditions	18°C, 64% RH	6dB Bandwidth	120 kHz
Antenna Pole	Vertical	Antenna Distance	10m
Detector Function	Quasi-peak.	Tested By	Tony Tsai

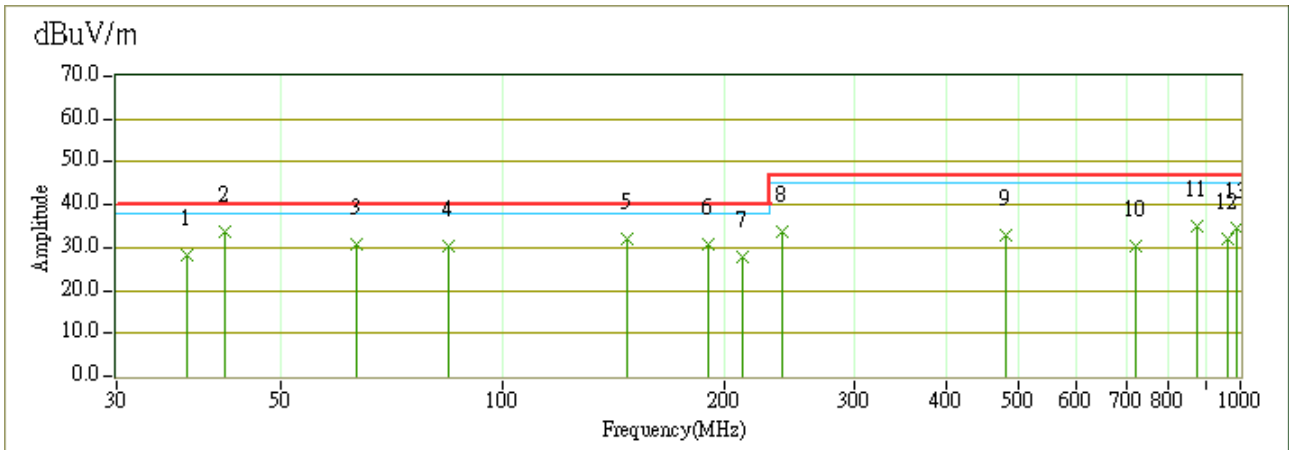

No.	Frequency (MHz)	Reading (dBuV)	Correction Factor(dB/m)	Result (dBuV/m)	Limit (dBuV/m)	Margin (dB)	Degree (°)	Height (cm)	Remark
1	37.27	41.99	-13.59	28.40	40.00	-11.60	159.90	100.00	QP
2	42.16	50.20	-16.41	33.79	40.00	-6.21	180.90	100.00	QP
3	63.25	52.18	-21.31	30.87	40.00	-9.13	346.60	100.00	QP
4	84.34	49.50	-18.98	30.51	40.00	-9.49	210.40	100.00	QP
5	147.91	48.45	-16.51	31.94	40.00	-8.06	177.30	100.00	QP
6	189.95	48.34	-17.42	30.92	40.00	-9.08	195.10	100.00	QP
7	211.69	44.74	-16.94	27.80	40.00	-12.20	293.40	100.00	QP
8	240.02	48.45	-14.91	33.54	47.00	-13.46	22.90	100.00	Peak
9	480.02	39.34	-6.52	32.83	47.00	-14.17	204.90	185.50	Peak
10	720.06	31.00	-0.72	30.28	47.00	-16.72	304.50	100.00	Peak
11	875.06	33.72	1.28	35.00	47.00	-12.00	123.40	100.00	QP
12	960.05	28.56	3.42	31.97	47.00	-15.03	0.00	100.00	Peak
13	990.15	30.05	4.46	34.51	47.00	-12.49	348.40	100.00	Peak

REMARKS: The other emission levels were very low against the limit.



Model No.	PCM-3362	Test Mode	Mode 1
Environmental Conditions	18°C, 64% RH	6dB Bandwidth	120 kHz
Antenna Pole	Horizontal	Antenna Distance	10m
Detector Function	Quasi-peak.	Tested By	Tony Tsai

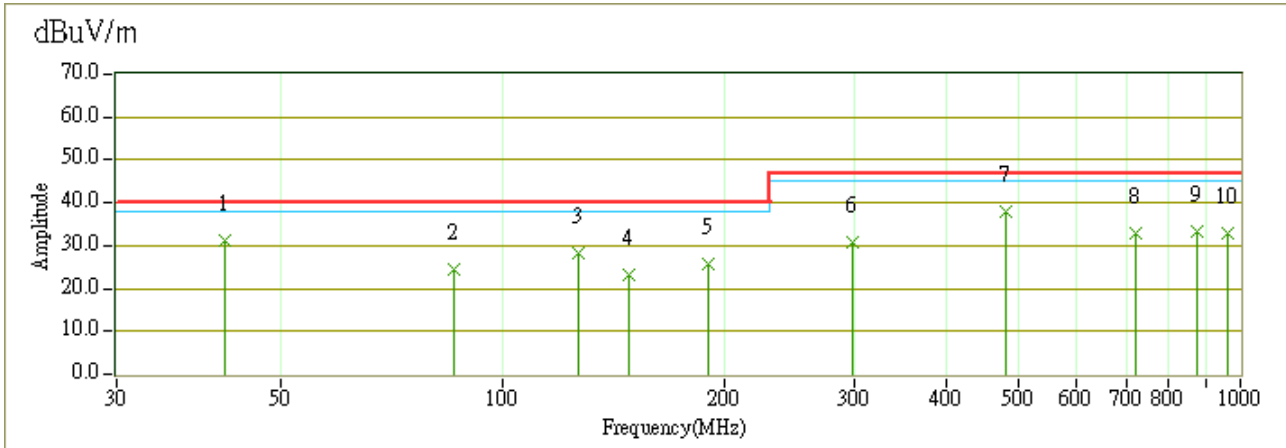

No.	Frequency (MHz)	Reading (dBuV)	Correction Factor(dB/m)	Result (dBuV/m)	Limit (dBuV/m)	Margin (dB)	Degree (°)	Height (cm)	Remark
1	42.14	47.79	-16.40	31.39	40.00	-8.61	110.50	399.90	QP
2	85.75	43.25	-18.64	24.61	40.00	-15.39	182.00	399.90	Peak
3	127.00	43.65	-15.45	28.20	40.00	-11.80	314.70	399.90	QP
4	148.71	39.91	-16.57	23.35	40.00	-16.65	114.60	399.90	Peak
5	190.19	43.33	-17.41	25.93	40.00	-14.07	255.50	399.90	QP
6	298.49	43.15	-12.35	30.80	47.00	-16.20	0.00	399.90	Peak
7	480.04	44.45	-6.52	37.93	47.00	-9.07	283.20	226.20	QP
8	720.08	33.62	-0.72	32.90	47.00	-14.10	247.60	100.00	QP
9	875.06	31.90	1.28	33.18	47.00	-13.82	101.60	100.00	QP
10	960.07	29.38	3.42	32.79	47.00	-14.21	103.60	100.00	QP

REMARKS: The other emission levels were very low against the limit.

Model No.	PCM-3362	Test Mode	Mode 4
Environmental Conditions	18°C, 64% RH	6dB Bandwidth	120 kHz
Antenna Pole	Vertical	Antenna Distance	10m
Detector Function	Quasi-peak.	Tested By	Tony Tsai

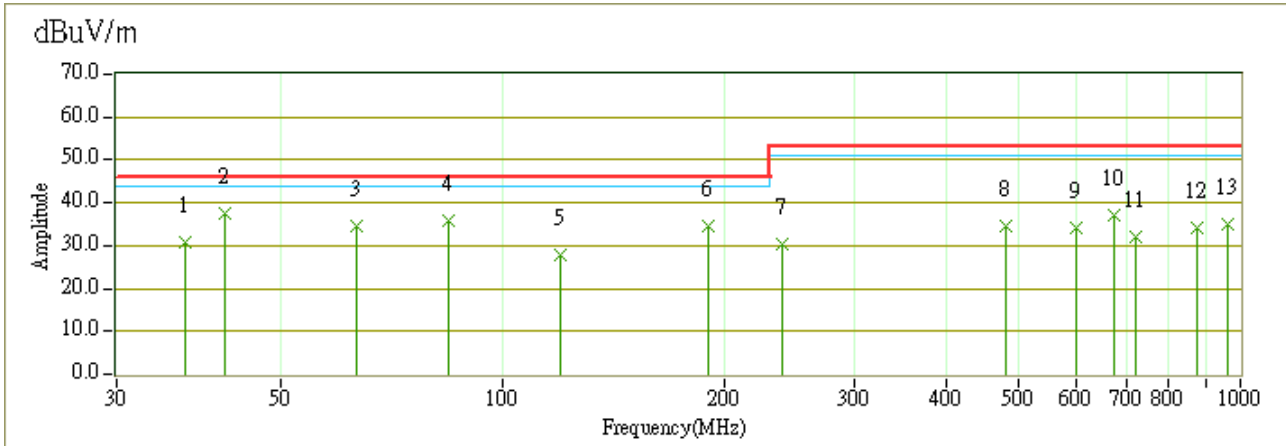

No.	Frequency (MHz)	Reading (dBuV)	Correction Factor (dB/m)	Result (dBuV/m)	Limit (dBuV/m)	Margin (dB)	Degree (°)	Height (cm)	Remark
1	37.24	44.53	-13.57	30.96	46.00	-15.04	111.60	100.00	QP
2	42.16	53.92	-16.41	37.50	46.00	-8.50	336.20	100.00	QP
3	63.25	55.92	-21.31	34.61	46.00	-11.39	128.70	100.00	QP
4	84.33	54.67	-18.98	35.68	46.00	-10.32	252.60	100.00	QP
5	120.02	42.96	-15.16	27.80	46.00	-18.20	193.70	100.00	Peak
6	190.01	52.05	-17.41	34.64	46.00	-11.36	127.80	100.00	QP
7	240.03	45.12	-14.91	30.21	53.00	-22.79	0.00	100.00	Peak
8	480.05	41.20	-6.52	34.68	53.00	-18.32	299.50	208.80	Peak
9	600.04	37.45	-3.16	34.29	53.00	-18.71	154.90	161.00	Peak
10	675.08	38.82	-1.69	37.12	53.00	-15.88	174.50	159.10	QP
11	720.02	32.97	-0.72	32.25	53.00	-20.75	14.60	100.00	Peak
12	875.01	32.69	1.28	33.97	53.00	-19.03	60.30	100.00	Peak
13	960.04	31.46	3.42	34.88	53.00	-18.12	268.80	100.00	Peak

REMARKS: The other emission levels were very low against the limit.



Model No.	PCM-3362	Test Mode	Mode 4
Environmental Conditions	18°C, 64% RH	6dB Bandwidth	120 kHz
Antenna Pole	Horizontal	Antenna Distance	10m
Detector Function	Quasi-peak.	Tested By	Tony Tsai

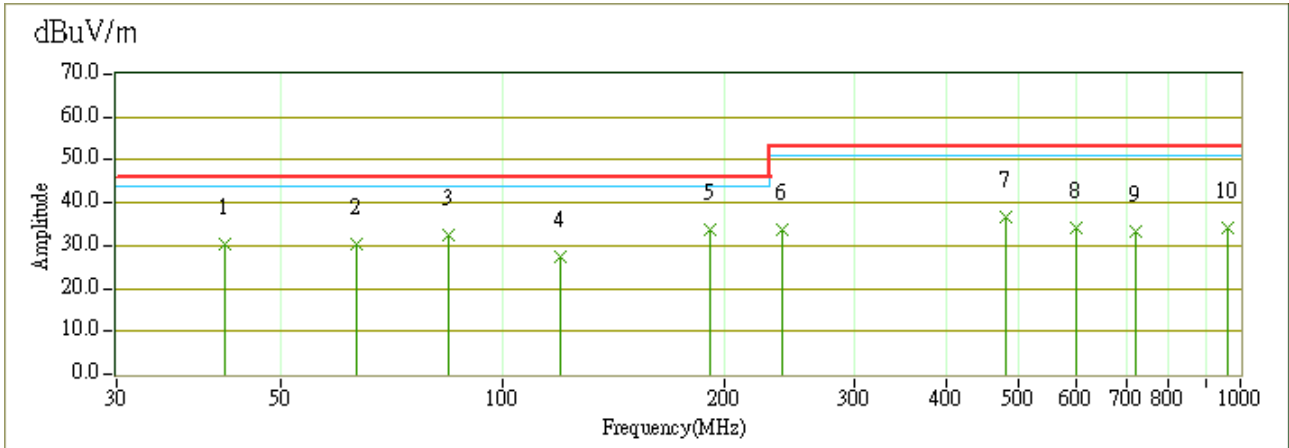

No.	Frequency (MHz)	Reading (dBuV)	Correction Factor(dB/m)	Result (dBuV/m)	Limit (dBuV/m)	Margin (dB)	Degree (°)	Height (cm)	Remark
1	42.16	46.66	-16.41	30.25	46.00	-15.75	222.40	399.90	QP
2	63.28	51.52	-21.31	30.21	46.00	-15.79	96.00	399.90	QP
3	84.35	51.46	-18.98	32.48	46.00	-13.52	78.00	399.90	QP
4	119.99	42.64	-15.16	27.48	46.00	-18.52	205.00	399.90	QP
5	190.70	51.28	-17.39	33.90	46.00	-12.10	158.30	399.90	QP
6	240.00	48.76	-14.91	33.85	53.00	-19.15	105.00	399.90	Peak
7	480.05	43.02	-6.52	36.50	53.00	-16.50	226.90	327.50	QP
8	600.03	37.15	-3.16	33.99	53.00	-19.01	83.70	179.90	Peak
9	720.01	33.94	-0.72	33.22	53.00	-19.78	325.20	100.00	Peak
10	960.00	30.91	3.42	34.33	53.00	-18.67	331.50	100.00	QP

REMARKS: The other emission levels were very low against the limit.



Above 1GHz

Model No.	PCM-3362	Test Mode	Mode 1
Environmental Conditions	18°C, 60% RH	Test Frequency Range	1GHz ~ 6GHz
Antenna Pole	Vertical	Antenna Distance	3m
Detector Function	Peak/Average	Tested By	Louis Shen

Frequency MHz	Corr. Factor (dBuV/m)	Reading		Result		Limit		Margin	
		Average (dBuV/m)	Peak (dBuV/m)	Average (dBuV/m)	Peak (dBuV/m)	Average (dBuV/m)	Peak (dBuV/m)	Average (dB)	Peak (dB)
1036.485	-9.40	--	50.33	--	40.93	--	76.00	--	-35.07
1424.573	-7.18	--	49.98	--	42.80	--	76.00	--	-33.20
1607.719	-6.08	--	45.98	--	39.90	--	76.00	--	-36.10
1847.212	-4.60	--	45.91	--	41.31	--	76.00	--	-34.69
2249.642	-2.79	--	44.97	--	42.18	--	76.00	--	-33.82
2643.304	-1.24	--	45.02	--	43.78	--	76.00	--	-32.22

- REMARKS:**
1. The other emission levels were very low against the limit.
 2. "--", means the average measurement was not performed when the measured peak data under the limit of average detection.



Model No.	PCM-3362	Test Mode	Mode 1
Environmental Conditions	18°C, 60% RH	Test Frequency Range	1GHz ~ 6GHz
Antenna Pole	Horizontal	Antenna Distance	3m
Detector Function	Peak/Average	Tested By	Louis Shen

Frequency MHz	Corr. Factor (dBuV/m)	Reading		Result		Limit		Margin	
		Average (dBuV/m)	Peak (dBuV/m)	Average (dBuV/m)	Peak (dBuV/m)	Average (dBuV/m)	Peak (dBuV/m)	Average (dB)	Peak (dB)
1424.573	-7.18	--	48.83	--	41.65	--	76.00	--	-34.35
1750.541	-5.20	--	46.40	--	41.20	--	76.00	--	-34.80
2056.865	-3.46	--	45.63	--	42.17	--	76.00	--	-33.83
2331.720	-2.51	--	44.51	--	42.00	--	76.00	--	-34.00
2561.707	-1.63	--	44.97	--	43.34	--	76.00	--	-32.66
2852.453	-0.25	--	44.32	--	44.07	--	76.00	--	-31.93

- REMARKS:**
1. The other emission levels were very low against the limit.
 2. "--", means the average measurement was not performed when the measured peak data under the limit of average detection.



7.4. HARMONICS CURRENT MEASUREMENT

7.4.1. LIMITS OF HARMONICS CURRENT MEASUREMENT

Limits for Class A equipment		Limits for Class D equipment		
Harmonics Order n	Max. permissible harmonics current A	Harmonics Order n	Max. permissible harmonics current per watt mA/W	Max. permissible harmonics current A
Odd harmonics		Odd Harmonics only		
3	2.30	3	3.4	2.30
5	1.14	5	1.9	1.14
7	0.77	7	1.0	0.77
9	0.40	9	0.5	0.40
11	0.33	11	0.35	0.33
13	0.21	13	0.30	0.21
15<=n<=39	0.15x15/n	15<=n<=39	3.85/n	0.15x15/n
Even harmonics				
2	1.08			
4	0.43			
6	0.30			
8<=n<=40	0.23x8/n			

- NOTE:** 1. Class A and Class D are classified according to item 7.4.3.
 2. According to section 7 of EN 61000-3-2, the above limits for all equipment except for lighting equipment having an active input power > 75 W and no limits apply for equipment with an active input power up to and including 75 W.

7.4.2. TEST INSTRUMENTS

Immunity Shielded Room				
Name of Equipment	Manufacturer	Model	Serial Number	Calibration Due
HARMONICS SYSTEM	EMC-PARTNER	HARMONICS-1000	094	12/14/2010
Test S/W	HARCS Immunity (4.10)			

- NOTE:** The calibration interval of the above test instruments is 12 months and the calibrations are traceable to NML/ROC and NIST/USA.

7.4.3. TEST PROCEDURE (please refer to measurement standard or CCS SOP PA-029)

- The EUT was placed on the top of a wooden table 0.8 meters above the ground and operated to produce the maximum harmonic components under normal operating conditions for each successive harmonic component in turn.
- The classification of EUT is according to section 5 of EN 61000-3-2.
- The EUT is classified as follows:

Class A: Balanced three-phase equipment, Household appliances excluding equipment as Class D, Tools excluding portable tools, Dimmers for incandescent lamps, audio equipment, equipment not specified in one of the three other classes.

Class B: Portable tools; Arc welding equipment which is not professional equipment.

Class C: Lighting equipment.

Class D: Equipment having a specified power less than or equal to 600 W of the following types: Personal computers and personal computer monitors and television receivers.

- The correspondent test program of test instrument to measure the current harmonics emanated from EUT is chosen. The measure time shall be not less than the time necessary for the EUT to be exercised.

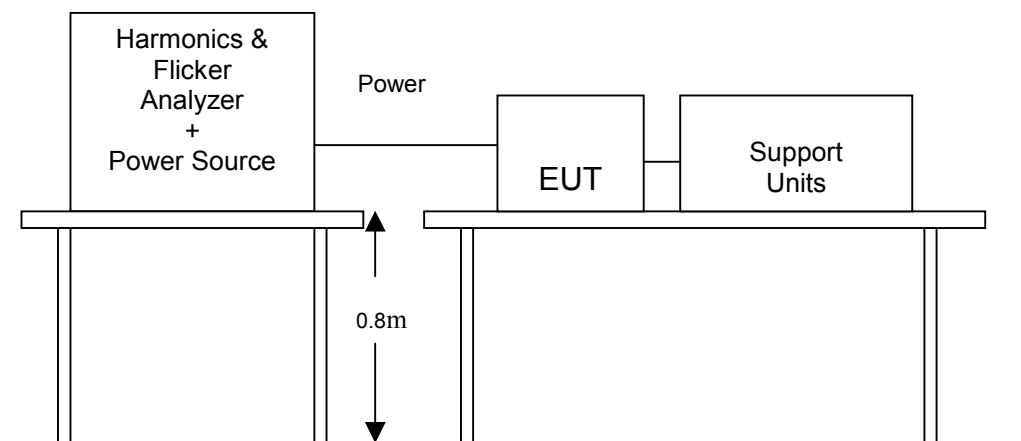
7.4.4. TEST SETUP

- For the actual test configuration, please refer to the related item – Photographs of the Test Configuration.

7.4.5. TEST RESULTS

EUT max Power : 28.74W

Note: According to clause 7 of EN 61000-3-2, equipment with a rated power of 75W or less, no limits apply.



7.5. VOLTAGE FLUCTUATION AND FLICKS MEASUREMENT

7.5.1. LIMITS OF VOLTAGE FLUCTUATION AND FLICKS MEASUREMENT

TEST ITEM	LIMIT	REMARK
P_{st}	1.0	P_{st} means short-term flicker indicator.
P_{lt}	0.65	P_{lt} means long-term flicker indicator.
T_{dt} (ms)	500	T_{dt} means maximum time that dt exceeds 3.3 %.
d_{max} (%)	4%	d_{max} means maximum relative voltage change.
dc (%)	3.3%	dc means relative steady-state voltage change

7.5.2. TEST INSTRUMENTS

Immunity Shielded Room				
Name of Equipment	Manufacturer	Model	Serial Number	Calibration Due
HARMONICS SYSTEM	EMC-PARTNER	HARMONICS-1000	094	12/14/2010
Test S/W	HARCS Immunity (4.10)			

NOTE: The calibration interval of the above test instruments is 12 months and the calibrations are traceable to NML/ROC and NIST/USA.

7.5.3. TEST PROCEDURE (please refer to measurement standard or CCS SOP PA-030)

- The EUT was placed on the top of a wooden table 0.8 meters above the ground and operated to produce the most unfavorable sequence of voltage changes under normal operating conditions.
- During the flick measurement, the measure time shall include that part of whole operation cycle in which the EUT produce the most unfavorable sequence of voltage changes. The observation period for short-term flicker indicator is 10 minutes and the observation period for long-term flicker indicator is 2 hours.

7.5.4. TEST SETUP

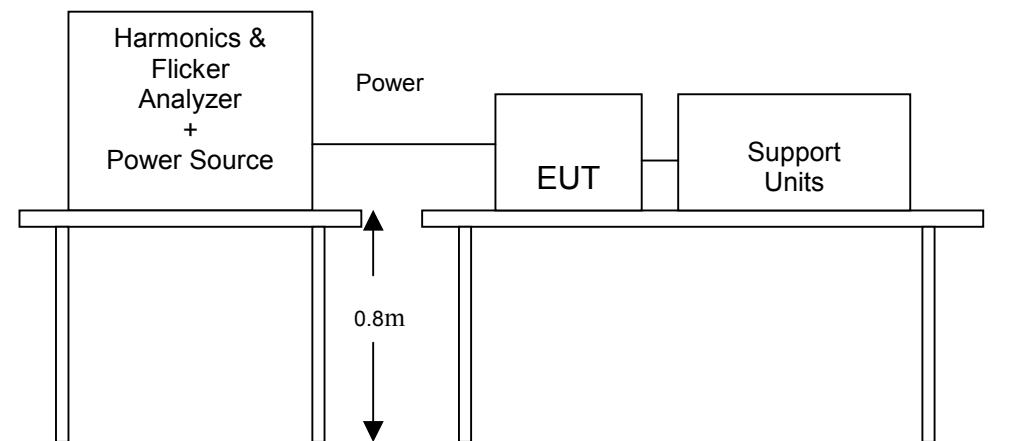

- For the actual test configuration, please refer to the related item – Photographs of the Test Configuration.

7.5.5. TEST RESULTS

Observation Period (Tp)	10mins	Test Mode	Mode 1
Environmental Conditions	25°C, 55% RH	Tested By	Carl Chang

Power Continuity

TEST PARAMETER	MEASUREMENT VALUE	LIMIT	REMARK
P _{st}	0.110	1.0	PASS
P _{lt}	0.110	0.65	PASS
T _{dt} (ms)	0	500	PASS
d _{max} (%)	0%	6%	PASS
dc (%)	0.01%	3.3%	PASS

Power Switched Manually

TEST PARAMETER	MEASUREMENT VALUE	LIMIT	REMARK
P _{st}	0.107	1.0	PASS
P _{lt}	0.107	0.65	PASS
T _{dt} (ms)	0	500	PASS
d _{max} (%)	0.32%	4%	PASS
dc (%)	0.05%	3.3%	PASS

Note: d_{max} (%) limit classified:

1. 6% for equipment which is switched manually or switched automatically more frequently than twice per day.
2. 7% for equipment which is attended whilst use or switched on automatically no more than twice per day



ADVANTECH

Date : 2009/12/24 AM 04:40: V4.16

Operator : Carl Chang
 Unit : PC/104-Plus CPU Module
 Serialnumber : PCM-3362
 Remarks : Temp:25 Hemid:55(Power Continuity)

Urms = 229.9V Freq = 49.909 Range: 1 A
 Irms = 0.162A Ipk = 0.272A cf = 1.686
 P = 27.51W S = 37.16VA pf = 0.740

Test - Time : 1 x 10min = 10min (100 %)

LIN (Line Impedance Network) : L: 0.24ohm +j0.15ohm N: 0.16ohm +j0.10ohm

Limits : Plt : 0.65 Pst : 1.00
 dmax : 4.00 % dc : 3.30 %
 dtLim: 3.30 % dt>Lim: 500ms

Test completed, Result: PASSED

Plt = 0.110

	Pst	dmax	dc	dt>Lim	Fail
		[%]	[%]	[ms]	
1	0.110	0.000	0.010	0.000	



ADVANTECH

Date : 2009/12/24 AM 04:52: V4.16

Operator : Carl Chang
 Unit : PC/104-Plus CPU Module
 Serialnumber : PCM-3362
 Remarks : Temp:25 Hemid:55(Power Switched Manually)

Urms = 229.9V Freq = 49.909 Range: 1 A
 Irms = 0.167A Ipk = 0.280A cf = 1.683
 P = 28.89W S = 38.28VA pf = 0.755

Test - Time : 1 x 10min = 10min (100 %)

LIN (Line Impedance Network) : L: 0.24ohm +j0.15ohm N: 0.16ohm +j0.10ohm

Limits : Plt : 0.65 Pst : 1.00
 dmax : 4.00 % dc : 3.30 %
 dtLim: 3.30 % dt>Lim: 500ms

Test completed, Result: PASSED

Plt = 0.107

	Pst	dmax	dc	dt>Lim	Fail
		[%]	[%]	[ms]	
1	0.107	0.320	0.050	0.000	

8 IMMUNITY TEST

8.1. GENERAL DESCRIPTION

Product Standard	EN 55024: 1998 + A1: 2001 + A2: 2003; EN 61000-6-2: 2005	
	Test Type	Minimum Requirement
Basic Standard, Specification, and Performance Criterion required	IEC 61000-4-2	Electrostatic Discharge – ESD: 8kV air discharge, 4kV Contact discharge, Performance Criterion B
	IEC 61000-4-3	Radio-Frequency Electromagnetic Field Susceptibility Test – RS: For EN 55024: 80 ~1000 MHz, 3V/m, 80% AM(1kHz), For EN 61000-6-2: 80 ~1000 MHz, 10V/m, 80% AM (1kHz), 1400 ~2000 MHz, 3V/m, 80% AM (1kHz), 2000 ~ 2700 MHz, 1V/m, 80% AM (1kHz), Performance Criterion A
	IEC 61000-4-4	Electrical Fast Transient/Burst - EFT, For EN 55024: AC Power Port: 1kV DC Power Port: 0.5kV Signal Ports and Telecommunication Ports: 0.5kV For EN 61000-6-2: AC Power Port: 2kV DC Power Port: 2kV Signal Ports: 1kV Performance Criterion B
	IEC 61000-4-5	Surge Immunity Test: 1.2/50 us or 10/700 us Open Circuit Voltage 8/20 μs or 5/320 Short Circuit Current For EN 55024: AC Power Port ~ line to line: 1kV, line to earth (ground): 2kV DC Power Port ~ line to earth: 0.5kV Signal Ports and Telecommunication Ports ~ line to ground: 1kV For EN 61000-6-2: AC Power Port ~ line to line: 1kV, line to earth: 2kV DC Power Port ~ line to earth: 0.5kV, line to line: 0.5kV Signal Ports ~ line to earth: 1kV Performance Criterion B
	IEC 61000-4-6	Conducted Radio Frequency Disturbances Test –CS: For EN 55024: 0.15 ~ 80 MHz, 3Vrms, 80% AM, 1kHz, For EN 61000-6-2: 0.15 ~ 80 MHz, 10Vrms, 80% AM, 1kHz, Performance Criterion A



Product Standard	EN 61000-6-2: 2005; EN 55024: 1998 + A1: 2001 + A2: 2003	
	Test Type	Minimum Requirement
Basic Standard, Specification, and Performance Criterion required	IEC 61000-4-8	Power frequency magnetic field immunity test For EN 55024: 50 Hz, 1A/m For EN 61000-6-2: 50/60 Hz, 30A/m Performance Criterion A
	IEC 61000-4-11	For EN 55024: Voltage Dips: i) >95% reduction for 0.5 period, Performance Criterion B ii) 30% reduction for 25 period, Performance Criterion C Voltage Interruptions: >95% reduction for 250 period Performance Criterion C For EN 61000-6-2: Voltage Dips: i) 0% reduction for 1 period, Performance Criterion B ii) 40% reduction for 10/12 period at 50/60Hz Performance Criterion C iii) 70% reduction for 25/30 period at 50/60Hz Performance Criterion C Voltage Interruptions: 0% reduction for 250/300 period at 50/60Hz Performance Criterion C



8.2. GENERAL PERFORMANCE CRITERIA DESCRIPTION

Criteria A:	The apparatus shell continues to operate as intended without operator intervention. No degradation of performance or loss of function is allowed below a performance level specified by the manufacturer, when the apparatus is used as intended. The performance level may be replaced by a permissible loss of performance. If the manufacturer does not specify the minimum performance level or the permissible performance loss, then either of these may be derived from the product description and documentation, and by what the user may reasonably expect from the equipment if used as intended.
Criteria B:	<p>After test, the apparatus shell continues to operate as intended without operator intervention. No degradation of performance or loss of function is allowed, after the application of the phenomenon below a performance level specified by the manufacturer, when the apparatus is used as intended. The performance level may be replaced by a permissible loss of performance.</p> <p>During the test, degradation of performance is however allowed. However, no change of operating state if stored data is allowed to persist after the test. If the manufacturer does not specify the minimum performance level or the permissible performance loss, then either of these may be derived from the product description and documentation, and by what the user may reasonably expect from the equipment if used as intended.</p>
Criteria C:	<p>Temporary loss of function is allowed, provided the functions is self-recoverable or can be restored by the operation of controls by the user in accordance with the manufacturer instructions.</p> <p>Functions, and/or information stored in non-volatile memory, or protected by a battery backup, shall not be lost.</p>



8.3. ELECTROSTATIC DISCHARGE (ESD)

8.3.1. TEST SPECIFICATION

Basic Standard:	IEC 61000-4-2
Discharge Impedance:	330 ohm / 150 pF
Discharge Voltage:	EN 55024; EN 61000-6-2 Air Discharge: 2 ; 4 ; 8 kV (Direct) Contact Discharge: 2 ; 4 kV (Direct/Indirect)
Polarity:	Positive & Negative Air Discharge: min. 10 times at single test point for each negative and positive polarity
Number of Discharge:	Contact Discharge: min. 200 times in total
Discharge Mode:	Single Discharge 1 second minimum

8.3.2. TEST INSTRUMENT

Immunity Shielded Room				
Name of Equipment	Manufacturer	Model	Serial Number	Calibration Due
ESD Generator	EM TEST	P30C	0603-01	09/14/2010

NOTE: The calibration interval of the above test instruments is 12 months and the calibrations are traceable to NML/ROC and NIST/USA.

8.3.3. TEST PROCEDURE (please refer to measurement standard or CCS SOP PA-022)

The discharges shall be applied in two ways:

a) Contact discharges to the conductive surfaces and coupling planes:

The EUT shall be exposed to at least 200 discharges, 100 each at negative and positive polarity, at a minimum of four test points. One of the test points shall be subjected to at least 50 indirect discharges to the center of the front edge of the **Horizontal Coupling Plane (HCP)**. The remaining three test points shall each receive at least 50 direct contact discharges. If no direct contact test points are available, then at least 200 indirect discharges shall be applied in the indirect mode. Test shall be performed at a maximum repetition rate of one discharge per second.

b) Air discharges at slots and apertures and insulating surfaces:

On those parts of the EUT where it is not possible to perform contact discharge testing, the equipment should be investigated to identify user accessible points where breakdown may occur. Such points are tested using the air discharge method. This investigation should be restricted to those area normally handled by the user. A minimum of 10 single air discharges shall be applied to the selected test point for each such area.

The basic test procedure was in accordance with IEC 61000-4-2:

- a) The EUT was located 0.1 m minimum from all side of the **HCP** (dimensions 1.6m x 0.8m).
- b) The support units were located another table 30 cm away from the EUT, but direct support unit was/were located at same location as EUT on the HCP and keep at a distance of 10 cm with EUT.
- c) The time interval between two successive single discharges was at least 1 second.
- d) Contact discharges were applied to the non-insulating coating, with the pointed tip of the generator penetrating the coating and contacting the conducting substrate.
- e) Air discharges were applied with the round discharge tip of the discharge electrode approaching the EUT as fast as possible (without causing mechanical damage) to touch the EUT. After each discharge, the ESD generator was removed from the EUT and re-triggered for a new single discharge. The test was repeated until all discharges were complete.
- f) At least ten single discharges (in the most sensitive polarity) were applied at the front edge of each **HCP** opposite the center point of each unit of the EUT and 0.1 meters from the front of the EUT. The long axis of the discharge electrode was in the plane of the **HCP** and perpendicular to its front edge during the discharge.
- g) At least ten single discharges (in the most sensitive polarity) were applied to the center of one vertical edge of the **Vertical Coupling Plane (VCP)** in sufficiently different positions that the four faces of the EUT were completely illuminated. The **VCP** (dimensions 0.5m x 0.5m) was placed vertically to and 0.1 meters from the EUT.

8.3.4. TEST SETUP

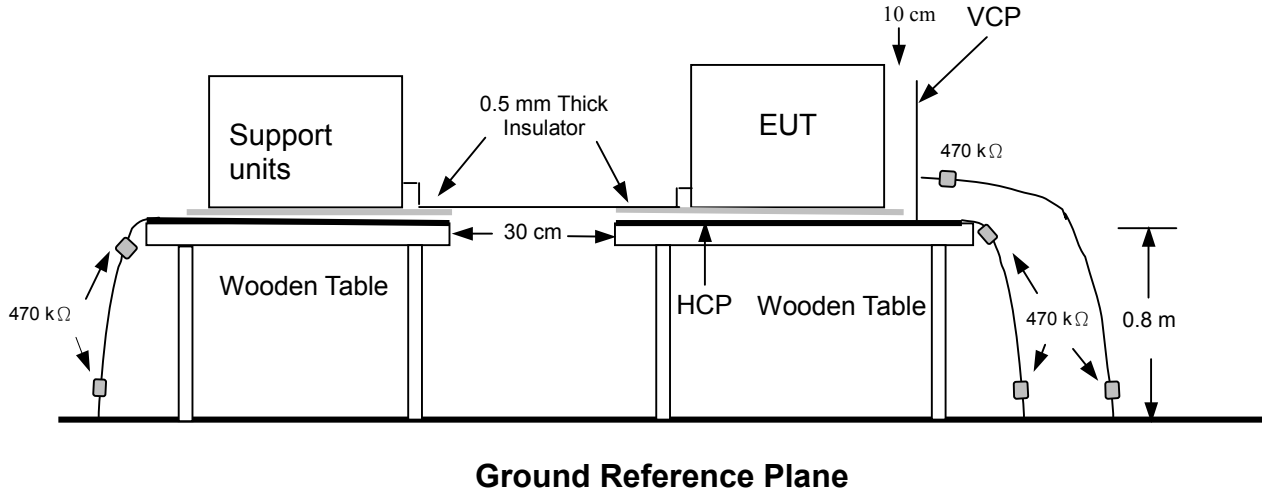

- For the actual test configuration, please refer to the related item – Photographs of the Test Configuration.

NOTE:

TABLE-TOP EQUIPMENT

The configuration consisted of a wooden table 0.8 meters high standing on the **Ground Reference Plane**. The **GRP** consisted of a sheet of aluminum at least 0.25mm thick, and 2.5 meters square connected to the protective grounding system. A **Horizontal Coupling Plane** (1.6m x 0.8m) was placed on the table and attached to the **GRP** by means of a cable with 940k . total impedance. The equipment under test, was installed in a representative system as described in section 7 of IEC 61000-4-2, and its cables were placed on the **HCP** and isolated by an insulating support of 0.5mm thickness. A distance of 1-meter minimum was provided between the EUT and the walls of the laboratory and any other metallic structure.

FLOOR-STANDING EQUIPMENT

The equipment under test was installed in a representative system as described in section 7 of IEC 61000-4-2, and its cables were isolated from the Ground Reference Plane by an insulating support of 0.1-meter thickness. The GRP consisted of a sheet of aluminum that is at least 0.25mm thick, and 2.5 meters square connected to the protective grounding system and extended at least 0.5 meters from the EUT on all sides.



8.3.5. TEST RESULTS

Temperature	19°C	Humidity	58% RH
Pressure	996mbar	Tested By	Tony Tsai
Required Passing Performance	Criterion B		

Air Discharge												
Test Points	Test Levels									Results		
	± 2 kV	Performance Criterion		± 4 kV	Performance Criterion		± 8 kV	Performance Criterion		Pass	Fail	Observation
Front	<input type="checkbox"/>	<input type="checkbox"/> A <input type="checkbox"/> B	<input type="checkbox"/>	<input type="checkbox"/> A <input type="checkbox"/> B	<input type="checkbox"/>	<input type="checkbox"/> A <input type="checkbox"/> B	<input type="checkbox"/>	<input type="checkbox"/> A <input type="checkbox"/> B	<input type="checkbox"/>	<input type="checkbox"/>		
Back	<input checked="" type="checkbox"/>	<input checked="" type="checkbox"/> A <input type="checkbox"/> B	<input checked="" type="checkbox"/>	<input checked="" type="checkbox"/> A <input type="checkbox"/> B	<input checked="" type="checkbox"/>	<input checked="" type="checkbox"/> A <input type="checkbox"/> B	<input checked="" type="checkbox"/>	<input checked="" type="checkbox"/> A <input type="checkbox"/> B	<input checked="" type="checkbox"/>	<input type="checkbox"/>	Note 1	
Left	<input type="checkbox"/>	<input type="checkbox"/> A <input type="checkbox"/> B	<input type="checkbox"/>	<input type="checkbox"/> A <input type="checkbox"/> B	<input type="checkbox"/>	<input type="checkbox"/> A <input type="checkbox"/> B	<input type="checkbox"/>	<input type="checkbox"/> A <input type="checkbox"/> B	<input type="checkbox"/>	<input type="checkbox"/>		
Right	<input type="checkbox"/>	<input type="checkbox"/> A <input type="checkbox"/> B	<input type="checkbox"/>	<input type="checkbox"/> A <input type="checkbox"/> B	<input type="checkbox"/>	<input type="checkbox"/> A <input type="checkbox"/> B	<input type="checkbox"/>	<input type="checkbox"/> A <input type="checkbox"/> B	<input type="checkbox"/>	<input type="checkbox"/>		
Top	<input type="checkbox"/>	<input type="checkbox"/> A <input type="checkbox"/> B	<input type="checkbox"/>	<input type="checkbox"/> A <input type="checkbox"/> B	<input type="checkbox"/>	<input type="checkbox"/> A <input type="checkbox"/> B	<input type="checkbox"/>	<input type="checkbox"/> A <input type="checkbox"/> B	<input type="checkbox"/>	<input type="checkbox"/>		
Bottom	<input type="checkbox"/>	<input type="checkbox"/> A <input type="checkbox"/> B	<input type="checkbox"/>	<input type="checkbox"/> A <input type="checkbox"/> B	<input type="checkbox"/>	<input type="checkbox"/> A <input type="checkbox"/> B	<input type="checkbox"/>	<input type="checkbox"/> A <input type="checkbox"/> B	<input type="checkbox"/>	<input type="checkbox"/>		

Contact Discharge												
Test Points	Test Levels									Results		
	± 2 kV	Performance Criterion		± 4 kV	Performance Criterion		± 8 kV	Performance Criterion		Pass	Fail	Observation
Front	<input checked="" type="checkbox"/>	<input checked="" type="checkbox"/> A <input type="checkbox"/> B	<input checked="" type="checkbox"/>	<input checked="" type="checkbox"/> A <input type="checkbox"/> B	<input type="checkbox"/>	<input type="checkbox"/> A <input type="checkbox"/> B	<input checked="" type="checkbox"/>	<input type="checkbox"/> A <input type="checkbox"/> B	<input checked="" type="checkbox"/>	<input type="checkbox"/>	Note 1	
Back	<input checked="" type="checkbox"/>	<input checked="" type="checkbox"/> A <input type="checkbox"/> B	<input checked="" type="checkbox"/>	<input checked="" type="checkbox"/> A <input type="checkbox"/> B	<input type="checkbox"/>	<input type="checkbox"/> A <input type="checkbox"/> B	<input checked="" type="checkbox"/>	<input type="checkbox"/> A <input type="checkbox"/> B	<input checked="" type="checkbox"/>	<input type="checkbox"/>	Note 1	
Left	<input checked="" type="checkbox"/>	<input checked="" type="checkbox"/> A <input type="checkbox"/> B	<input checked="" type="checkbox"/>	<input checked="" type="checkbox"/> A <input type="checkbox"/> B	<input type="checkbox"/>	<input type="checkbox"/> A <input type="checkbox"/> B	<input checked="" type="checkbox"/>	<input type="checkbox"/> A <input type="checkbox"/> B	<input checked="" type="checkbox"/>	<input type="checkbox"/>	Note 1	
Right	<input checked="" type="checkbox"/>	<input checked="" type="checkbox"/> A <input type="checkbox"/> B	<input checked="" type="checkbox"/>	<input checked="" type="checkbox"/> A <input type="checkbox"/> B	<input type="checkbox"/>	<input type="checkbox"/> A <input type="checkbox"/> B	<input checked="" type="checkbox"/>	<input type="checkbox"/> A <input type="checkbox"/> B	<input checked="" type="checkbox"/>	<input type="checkbox"/>	Note 1	
Top	<input checked="" type="checkbox"/>	<input checked="" type="checkbox"/> A <input type="checkbox"/> B	<input checked="" type="checkbox"/>	<input checked="" type="checkbox"/> A <input type="checkbox"/> B	<input type="checkbox"/>	<input type="checkbox"/> A <input type="checkbox"/> B	<input checked="" type="checkbox"/>	<input type="checkbox"/> A <input type="checkbox"/> B	<input checked="" type="checkbox"/>	<input type="checkbox"/>	Note 1	
Bottom	<input type="checkbox"/>	<input type="checkbox"/> A <input type="checkbox"/> B	<input type="checkbox"/>	<input type="checkbox"/> A <input type="checkbox"/> B	<input type="checkbox"/>	<input type="checkbox"/> A <input type="checkbox"/> B	<input type="checkbox"/>	<input type="checkbox"/> A <input type="checkbox"/> B	<input type="checkbox"/>	<input type="checkbox"/>		

For the tested points to EUT, please refer to attached page.
 (Blue arrow mark for Contact Discharge and red arrow mark for Air Discharge)

Discharge To Horizontal Coupling Plane								
Side of EUT	Test Levels			Results				
	± 2 kV	± 4 kV	± 8 kV	Pass	Fail	Performance Criterion		Observation
Front	<input checked="" type="checkbox"/>	<input checked="" type="checkbox"/>	<input type="checkbox"/>	<input checked="" type="checkbox"/>	<input type="checkbox"/>	<input checked="" type="checkbox"/> A <input type="checkbox"/> B		Note 1
Back	<input checked="" type="checkbox"/>	<input checked="" type="checkbox"/>	<input type="checkbox"/>	<input checked="" type="checkbox"/>	<input type="checkbox"/>	<input checked="" type="checkbox"/> A <input type="checkbox"/> B		Note 1
Left	<input checked="" type="checkbox"/>	<input checked="" type="checkbox"/>	<input type="checkbox"/>	<input checked="" type="checkbox"/>	<input type="checkbox"/>	<input checked="" type="checkbox"/> A <input type="checkbox"/> B		Note 1
Right	<input checked="" type="checkbox"/>	<input checked="" type="checkbox"/>	<input type="checkbox"/>	<input checked="" type="checkbox"/>	<input type="checkbox"/>	<input checked="" type="checkbox"/> A <input type="checkbox"/> B		Note 1

Discharge To Vertical Coupling Plane								
Side of EUT	Test Levels			Results				
	± 2 kV	± 4 kV	± 8 kV	Pass	Fail	Performance Criterion		Observation
Front	<input checked="" type="checkbox"/>	<input checked="" type="checkbox"/>	<input type="checkbox"/>	<input checked="" type="checkbox"/>	<input type="checkbox"/>	<input checked="" type="checkbox"/> A <input type="checkbox"/> B		Note 1
Back	<input checked="" type="checkbox"/>	<input checked="" type="checkbox"/>	<input type="checkbox"/>	<input checked="" type="checkbox"/>	<input type="checkbox"/>	<input checked="" type="checkbox"/> A <input type="checkbox"/> B		Note 1
Left	<input checked="" type="checkbox"/>	<input checked="" type="checkbox"/>	<input type="checkbox"/>	<input checked="" type="checkbox"/>	<input type="checkbox"/>	<input checked="" type="checkbox"/> A <input type="checkbox"/> B		Note 1
Right	<input checked="" type="checkbox"/>	<input checked="" type="checkbox"/>	<input type="checkbox"/>	<input checked="" type="checkbox"/>	<input type="checkbox"/>	<input checked="" type="checkbox"/> A <input type="checkbox"/> B		Note 1

NOTE: 1. There was no change compared with initial operation during the test.

The Tested Points of EUT

Photo 1 of 4



Photo 2 of 4



Photo 3 of 4



Photo 4 of 4





8.4. RADIATED, RADIO-FREQUENCY, ELECTROMAGNETIC FIELD (RS)

8.4.1. TEST SPECIFICATION

Basic Standard:	IEC 61000-4-3
Frequency Range:	For EN 55024: 80 MHz ~1000 MHz, For EN 61000-6-2: 80 MHz ~1000 MHz, 1400 MHz ~2000 MHz, 2000 MHz ~27000 MHz
Field Strength:	EN 55024: 3 V/m EN 61000-6-2: 10 V/m, 3 V/m, 1 V/m
Modulation:	1kHz Sine Wave, 80%, AM Modulation
Frequency Step:	1 % of preceding frequency value
Polarity of Antenna:	Horizontal and Vertical
Test Distance:	3 m
Antenna Height:	1.5m

8.4.2. TEST INSTRUMENT

733 RS Chamber(80-1000MHz)				
Name of Equipment	Manufacturer	Model	Serial Number	Calibration Due
S.G.	Agilent	8648C	4108A05772	11/06/2010
Power Meter	R&S	NRVD	837794/029	08/11/2010
Power Sensor	R&S	URV5-Z2	835640/015	08/11/2010
Power Sensor	R&S	URV5-Z2	835640/016	08/11/2010
Power Amplifier	ar	150W1000	300300	N.C.R
Power Amplifier	ar	60S1G3M3	0328274	N.C.R
Bilog Antenna	SCHAFFNER	CBL 6140A	1221	N.C.R
Horn Antenna	EMCO	3115	00022257	12/21/2010
EM PROBE	ar	FL7006	0330722	02/17/2010
Test S/W	SW1006 (V1.13)			



733 RS Chamber (1400-2700MHz)				
Name of Equipment	Manufacturer	Model	Serial Number	Calibration Due
S.G.	Agilent	8648C	4108A05773	10/14/2010
Power Meter	BOONTON	4232A	98501	10/02/2010
Power Amplifier	ar	150W1000M3	306730	N.C.R
Power Amplifier	ar	30S1G3M1	306722	N.C.R
RF Test Sys Ctrlr	ar	SC1000M3	306666	N.C.R
Bilog Antenna	ar	AT1080	306709	N.C.R
Horn Antenna	ar	AT4002	306750	N.C.R
Test S/W	EMS-K1 (V1.20)			

NOTE: 1. The calibration interval of the above test instruments is 12 months and the calibrations are traceable to NML/ROC and NIST/USA.
 2. N.C.R.= No Calibration required

8.4.3. TEST PROCEDURE (please refer to measurement standard or CCS SOP PA-023)

The test procedure was in accordance with IEC 61000-4-3

- a) The testing was performed in a fully anechoic chamber. The transmit antenna was located at a distance of 3 meters from the EUT.
- b) The frequency range is swept from 80 MHz to 1000 MHz, with the signal 80% amplitude modulated with a 1kHz sine-wave. The rate of sweep did not exceed 1.5×10^{-3} decade/s, where the frequency range is swept incrementally, the step size was 1% of preceding frequency value.
- c) The dwell time at each frequency shall be not less than the time necessary for the EUT to be able to respond.
- e) The test was performed with the EUT exposed to both vertically and horizontally polarized fields on each of the four sides.

8.4.4. TEST SETUP

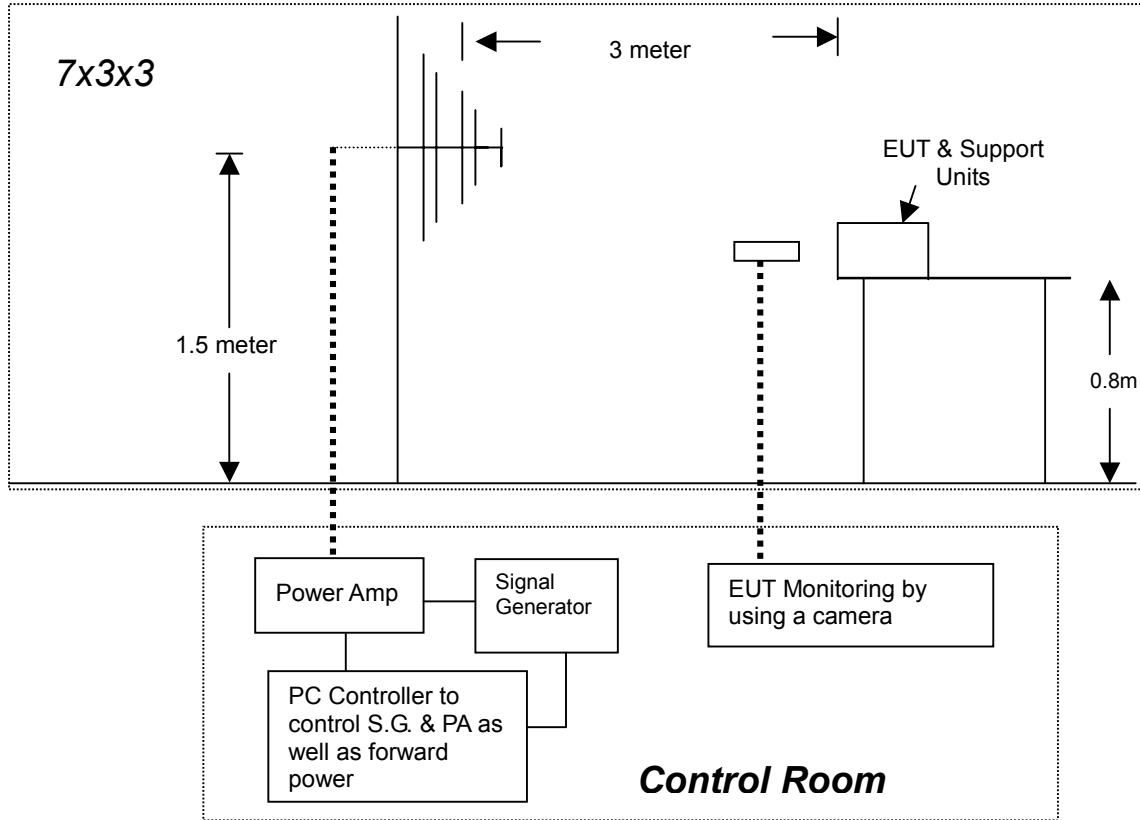

- For the actual test configuration, please refer to the related item – Photographs of the Test Configuration.

NOTE:

TABLETOP EQUIPMENT

The EUT installed in a representative system as described in section 7 of IEC 61000-4-3 was placed on a non-conductive table 0.8 meters in height. The system under test was connected to the power and signal wire according to relevant installation instructions.

FLOOR STANDING EQUIPMENT

The EUT installed in a representative system as described in section 7 of IEC 61000-4-3 was placed on a non-conductive wood support 0.1 meters in height. The system under test was connected to the power and signal wire according to relevant installation instructions.



8.4.5. TEST RESULTS

Temperature	19°C	Humidity	58% RH
Pressure	990mbar	Dwell Time	3 sec.
Tested By	Tony Tsai	Required Passing Performance	Criterion A

For EN 55024:

Frequency (MHz)	Polarity	Azimuth	Field Strength (V/m)	Performance Criterion	Observation	Result
80 ~ 1000	V&H	0	3	<input checked="" type="checkbox"/> A <input type="checkbox"/> B	Note 1	PASS
80 ~ 1000	V&H	90	3	<input checked="" type="checkbox"/> A <input type="checkbox"/> B	Note 1	PASS
80 ~ 1000	V&H	180	3	<input checked="" type="checkbox"/> A <input type="checkbox"/> B	Note 1	PASS
80 ~ 1000	V&H	270	3	<input checked="" type="checkbox"/> A <input type="checkbox"/> B	Note 1	PASS

For EN 61000-6-2:

Frequency (MHz)	Polarity	Azimuth	Field Strength (V/m)	Performance Criterion	Observation	Result
80 ~ 1000	V&H	0	10	<input checked="" type="checkbox"/> A <input type="checkbox"/> B	Note 1	PASS
80 ~ 1000	V&H	90	10	<input checked="" type="checkbox"/> A <input type="checkbox"/> B	Note 1	PASS
80 ~ 1000	V&H	180	10	<input checked="" type="checkbox"/> A <input type="checkbox"/> B	Note 1	PASS
80 ~ 1000	V&H	270	10	<input checked="" type="checkbox"/> A <input type="checkbox"/> B	Note 1	PASS
1400 ~ 2000	V&H	0	3	<input checked="" type="checkbox"/> A <input type="checkbox"/> B	Note 1	PASS
1400 ~ 2000	V&H	90	3	<input checked="" type="checkbox"/> A <input type="checkbox"/> B	Note 1	PASS
1400 ~ 2000	V&H	180	3	<input checked="" type="checkbox"/> A <input type="checkbox"/> B	Note 1	PASS
1400 ~ 2000	V&H	270	3	<input checked="" type="checkbox"/> A <input type="checkbox"/> B	Note 1	PASS
2000 ~ 2700	V&H	0	1	<input checked="" type="checkbox"/> A <input type="checkbox"/> B	Note 1	PASS
2000 ~ 2700	V&H	90	1	<input checked="" type="checkbox"/> A <input type="checkbox"/> B	Note 1	PASS
2000 ~ 2700	V&H	180	1	<input checked="" type="checkbox"/> A <input type="checkbox"/> B	Note 1	PASS
2000 ~ 2700	V&H	270	1	<input checked="" type="checkbox"/> A <input type="checkbox"/> B	Note 1	PASS

NOTE: 1. There was no change compared with the initial operation during the test.



8.5. ELECTRICAL FAST TRANSIENT (EFT)

8.5.1. TEST SPECIFICATION

Basic Standard:	IEC 61000-4-4
Test Voltage:	For EN 55024: AC Power Port: 1kV DC Power Port: 0.5kV Signal Ports and Telecommunication Ports: 0.5kV
	For EN 61000-6-2: AC Power Port: 2kV DC Power Port: 2kV Signal Ports: 1kV
Polarity:	Positive & Negative
Impulse Frequency:	5 kHz
Impulse Wave-shape:	5/50 ns
Burst Duration:	15 ms
Burst Period:	3 Hz
Test Duration:	Not less than 1 min.

8.5.2. TEST INSTRUMENT

Immunity Shield Room				
Name of Equipment	Manufacturer	Model	Serial Number	Calibration Due
EMC TEST SYSTEM	EMC-PARTNER	TRANSIENT-2000	754	09/01/2010
Clamp	HAEFELY TRENCH	093 506.1	080 421.13	N.C.R
Test S/W	Genecs (2.54)			

NOTE: 1. The calibration interval of the above test instruments is 12 months and the calibrations are traceable to NML/ROC and NIST/USA.
 2. N.C.R.= No Calibration required

8.5.3. TEST PROCEDURE (please refer to measurement standard or CCS SOP PA-024)

- a) Both positive and negative polarity discharges were applied.
- b) The length of the “hot wire” from the coaxial output of the EFT generator to the terminals on the EUT should not exceed 1 meter.
- c) The duration time of each test sequential was 1 minute.
- d) The transient/burst waveform was in accordance with IEC 61000-4-4, 5/50ns.

8.5.4. TEST SETUP

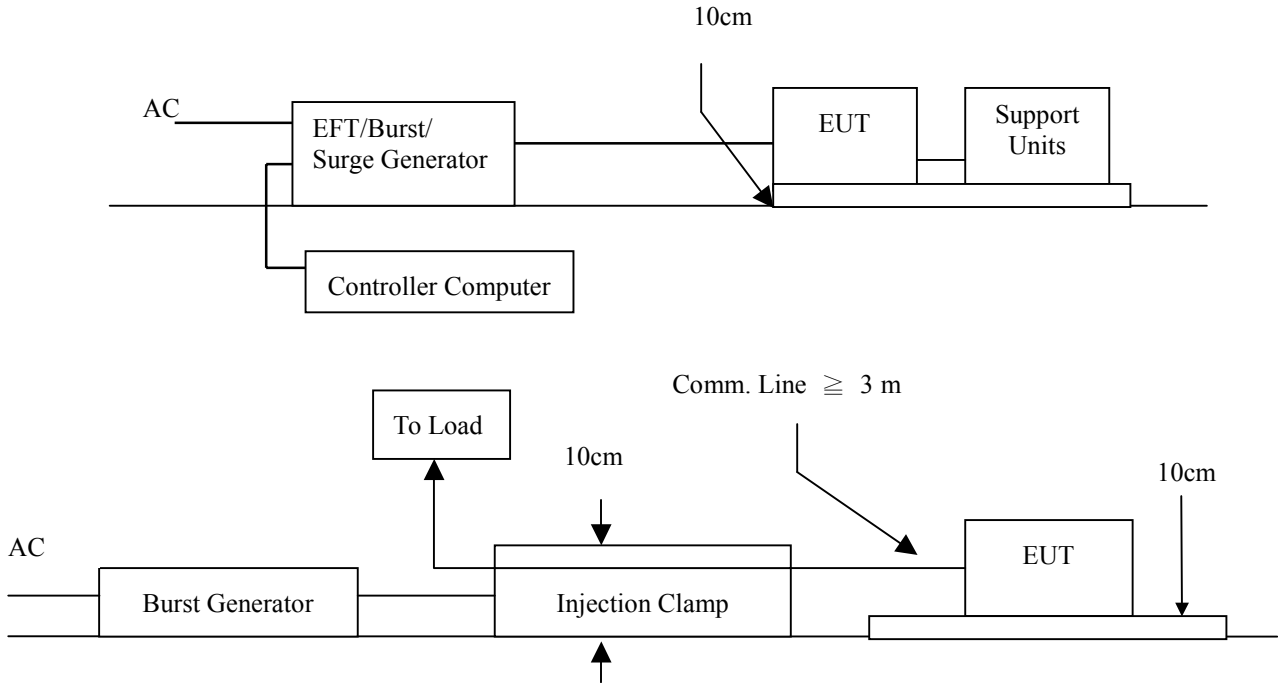

- For the actual test configuration, please refer to the related item – Photographs of the Test Configuration.

NOTE:

TABLETOP EQUIPMENT

The configuration consisted of a wooden table (0.8m high) standing on the Ground Reference Plane. The GRP consisted of a sheet of aluminum (at least 0.25mm thick and 2.5m square) connected to the protective grounding system. A minimum distance of 0.5m was provided between the EUT and the walls of the laboratory or any other metallic structure.

FLOOR STANDING EQUIPMENT

The EUT installed in a representative system as described in section 7 of IEC 61000-4-4 and its cables, were isolated from the Ground Reference Plane by an insulating support that is 0.1-meter thick. The GRP consisted of a sheet of aluminum (at least 0.25mm thick and 2.5m square) connected to the protective grounding system.



8.5.5. TEST RESULTS

Temperature	20, 21°C	Humidity	60, 59% RH
Pressure	992mbar	Tested By	Tony Tsai
Required Passing Performance		Criterion B	

For EN 55024:

Test Point	Polarity	Test Level (kV)	Performance Criterion	Observation	Result
L	+/-	1	<input checked="" type="checkbox"/> A <input type="checkbox"/> B	Note 1	PASS
N	+/-	1	<input checked="" type="checkbox"/> A <input type="checkbox"/> B	Note 1	PASS
PE	+/-	1	<input checked="" type="checkbox"/> A <input type="checkbox"/> B	Note 1	PASS
L+N	+/-	1	<input checked="" type="checkbox"/> A <input type="checkbox"/> B	Note 1	PASS
L +PE	+/-	1	<input checked="" type="checkbox"/> A <input type="checkbox"/> B	Note 1	PASS
N + PE	+/-	1	<input checked="" type="checkbox"/> A <input type="checkbox"/> B	Note 1	PASS
L +N +PE	+/-	1	<input checked="" type="checkbox"/> A <input type="checkbox"/> B	Note 1	PASS
LAN	+/-	0.5	<input checked="" type="checkbox"/> A <input type="checkbox"/> B	Note 1	PASS

For EN 61000-6-2:

Test Point	Polarity	Test Level (kV)	Performance Criterion	Observation	Result
L	+/-	2	<input checked="" type="checkbox"/> A <input type="checkbox"/> B	Note 1	PASS
N	+/-	2	<input checked="" type="checkbox"/> A <input type="checkbox"/> B	Note 1	PASS
PE	+/-	2	<input checked="" type="checkbox"/> A <input type="checkbox"/> B	Note 1	PASS
L+N	+/-	2	<input checked="" type="checkbox"/> A <input type="checkbox"/> B	Note 1	PASS
L +PE	+/-	2	<input checked="" type="checkbox"/> A <input type="checkbox"/> B	Note 1	PASS
N + PE	+/-	2	<input checked="" type="checkbox"/> A <input type="checkbox"/> B	Note 1	PASS
L +N +PE	+/-	2	<input checked="" type="checkbox"/> A <input type="checkbox"/> B	Note 1	PASS
LAN	+/-	1	<input checked="" type="checkbox"/> A <input type="checkbox"/> B	Note 1	PASS

NOTE: 1. There was no change compared with initial operation during the test.



8.6. SURGE IMMUNITY TEST

8.6.1. TEST SPECIFICATION

Basic Standard:	IEC 61000-4-5
Wave-Shape:	Combination Wave 1.2/50 us or 10/700 us Open Circuit Voltage 8/20 μs or 5/320 Short Circuit Current
Test Voltage:	For EN 55024: AC Power Port ~ line to line: 1kV, line to earth (ground): 2kV DC Power Port ~ line to earth: 0.5kV Signal Ports and Telecommunication Ports ~ line to ground: 1kV For EN 61000-6-2: AC Power Port ~ line to line: 1kV, line to earth: 2kV DC Power Port ~ line to earth: 0.5kV, line to line: 0.5kV Signal Ports ~ line to earth: 1k
Surge Input/Output:	Power Line: L1-L2 / L1-PE / L2-PE
Generator Source Impedance:	2 ohm between networks 12 ohm between network and ground
Polarity:	Positive/Negative
Phase Angle:	0 / 90 / 180 / 270
Pulse Repetition Rate:	1 time / min. (maximum)
Number of Tests:	5 positive and 5 negative at selected points

8.6.2. TEST INSTRUMENT

Immunity Shield Room				
Name of Equipment	Manufacturer	Model	Serial Number	Calibration Due
Surge Tester	HAEFELY TRENCH	PSUGER 4010	583 334-71	09/01/2010
Test S/W	Winpats (3.25)			

NOTE: 1. The calibration interval of the above test instruments is 12 months and the calibrations are traceable to NML/ROC and NIST/USA.
2. N.C.R.= No Calibration required

8.6.3. TEST PROCEDURE (please refer to measurement standard or CCS SOP PA-025)

a) For EUT power supply:

The surge is applied to the EUT power supply terminals via the capacitive coupling network. Decoupling networks are required in order to avoid possible adverse effects on equipment not under test that may be powered by the same lines, and to provide sufficient decoupling impedance to the surge wave. The power cord between the EUT and the coupling/decoupling networks was shorter than 2 meters in length.

b) For test applied to unshielded un-symmetrically operated interconnection lines of EUT:

The surge was applied to the lines via the capacitive coupling. The coupling / decoupling networks didn't influence the specified functional conditions of the EUT. The interconnection line between the EUT and the coupling/decoupling networks was shorter than 2 meters in length.

c) For test applied to unshielded symmetrically operated interconnection / telecommunication lines of EUT:

The surge was applied to the lines via gas arrestors coupling. Test levels below the ignition point of the coupling arrestor were not specified. The interconnection line between the EUT and the coupling/decoupling networks was shorter than 2 meters in length.

8.6.4. TEST SETUP

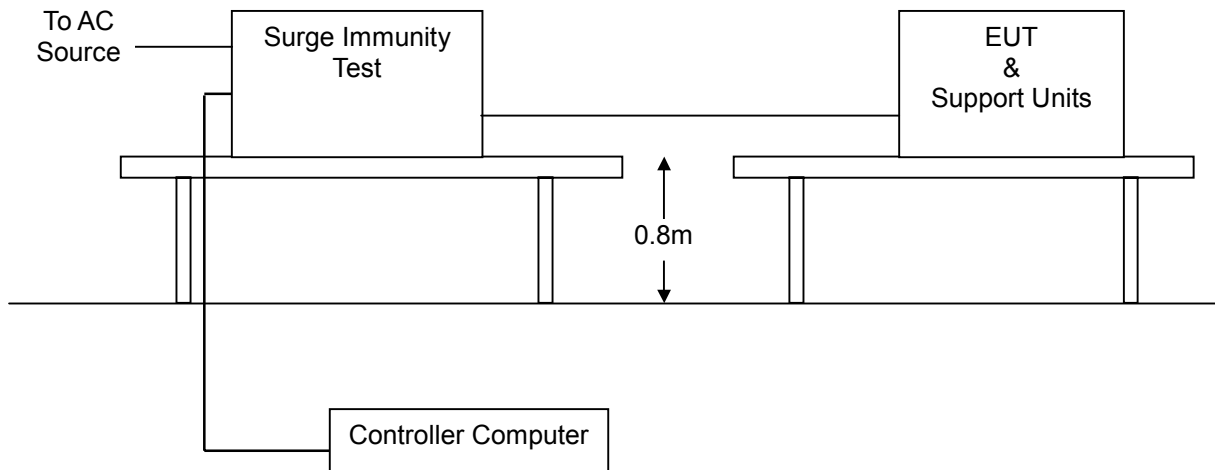

- For the actual test configuration, please refer to the related item – Photographs of the Test Configuration.



8.6.5. TEST RESULTS

Temperature	20, 21°C	Humidity	60, 59% RH
Pressure	992mbar	Tested By	Tony Tsai
Required Passing Performance	Criterion B		

Test Point	Polarity	Test Level (kV)	Performance Criterion	Observation	Result
L-N	+/-	1	<input checked="" type="checkbox"/> A <input type="checkbox"/> B	Note 1	PASS
L - PE	+/-	2	<input checked="" type="checkbox"/> A <input type="checkbox"/> B	Note 1	PASS
N - PE	+/-	2	<input checked="" type="checkbox"/> A <input type="checkbox"/> B	Note 1	PASS

NOTE: 1. There was no change compared with initial operation during the test.



8.7. CONDUCTED RADIO FREQUENCY DISTURBANCES (CS)

8.7.1. TEST SPECIFICATION

Basic Standard:	IEC 61000-4-6
Frequency Range:	0.15 MHz ~ 80 MHz
	For EN 55024:
Field Strength:	3 Vrms
	For EN 61000-6-2:
	10 Vrms
Modulation:	1kHz Sine Wave, 80%, AM Modulation
Frequency Step:	1 % of preceding frequency value
Coupled cable:	Power Mains, Unshielded
Coupling device:	CDN-M3 (3 wires)
	CDN-T8 for LAN

8.7.2. TEST INSTRUMENT

Immunity Shield Room				
Name of Equipment	Manufacturer	Model	Serial Number	Calibration Due
S.G.	Agilent	8648C	4108A05772	11/06/2010
Power Meter	R&S	NRVD	837794/029	08/11/2010
Power Sensor	R&S	URV5-Z2	835640/015	08/11/2010
Power Sensor	R&S	URV5-Z2	835640/016	08/11/2010
Power Amplifier	ar	75A250AM1	306334	N.C.R
CDN	FCC	FCC-801-M3-16A	99122	11/09/2010
CDN	FCC	FCC-801-T8-RJ45	04023	07/08/2010
Test S/W	SW1006 (V1.13)			

NOTE: 1. The calibration interval of the above test instruments is 12 months and the calibrations are traceable to NML/ROC and NIST/USA.
 2. N.C.R.= No Calibration required



8.7.3. TEST PROCEDURE (please refer to measurement standard or CCS SOP PA-026)

The EUT shall be tested within its intended operating and climatic conditions.

The test shall be performed with the test generator connected to each of the coupling and decoupling devices in turn, while the other non-excited RF input ports of the coupling devices are terminated by a 50-ohm load resistor.

The frequency range was swept from 150 kHz to 80 MHz, using the signal level established during the setting process and with a disturbance signal of 80 % amplitude. The signal was modulated with a 1 kHz sine wave, pausing to adjust the RF signal level or the switch coupling devices as necessary. The sweep rate was 1.5×10^{-3} decades/s. Where the frequency range is swept incrementally, the step size was 1 % of preceding frequency value from 150 kHz to 80 MHz.

The dwell time at each frequency was less than the time necessary for the EUT to be exercised, and able to respond. Sensitive frequencies such as clock frequency(ies) and harmonics or frequencies of dominant interest, was analyzed separately.

Attempts were made to fully exercise the EUT during testing, and to fully interrogate all exercise modes selected for susceptibility.

8.7.4. TEST SETUP

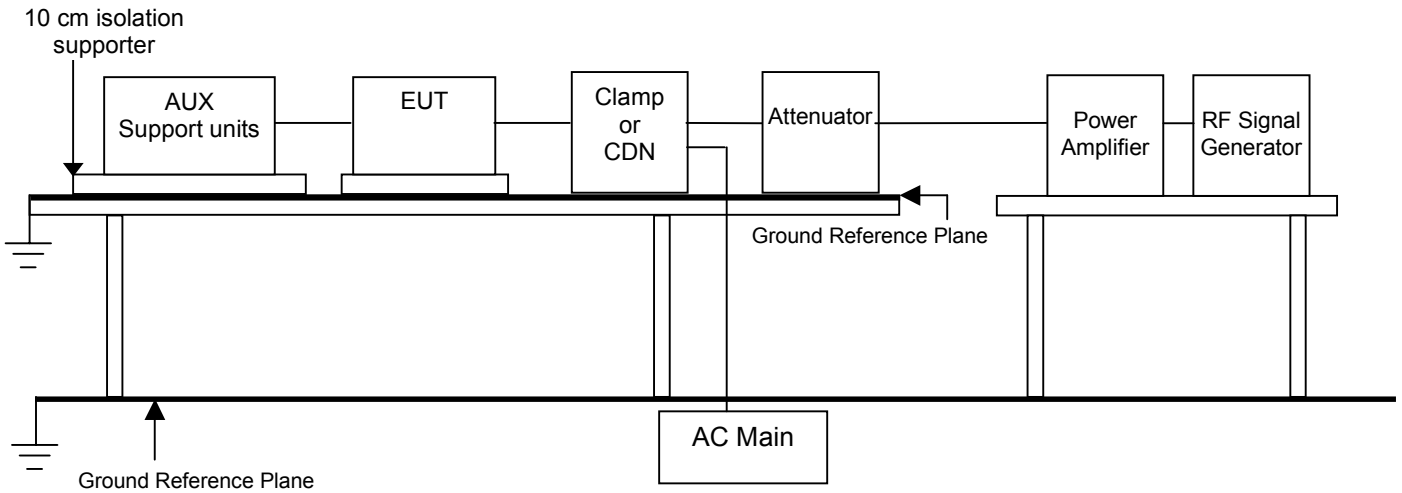

- Note:**
1. The EUT is setup 0.1m above Ground Reference Plane
 2. The CDNs and / or EM clamp used for real test depends on ports and cables configuration of EUT.

- For the actual test configuration, please refer to the related item – Photographs of the Test Configuration.

NOTE:

TABLE-TOP AND FLOOR-STANDING EQUIPMENT

The equipment to be tested was placed on an insulating support of 0.1 meters height above a ground reference plane. All relevant cables shall be provided with the appropriate coupling and decoupling devices at a distance between 0.1 meters and 0.3 meters from the projected geometry of the EUT on the ground reference plane.



8.7.5. TEST RESULTS

Temperature	19°C	Humidity	58% RH
Pressure	996mbar	Tested By	Tony Tsai
Required Passing Performance		Criterion A	

EN 55024:

Frequency Band (MHz)	Field Strength (Vrms)	Cable	Injection Method	Performance Criterion	Observation	Result
0.15 ~ 80	3	Power Line	CDN-M3	<input checked="" type="checkbox"/> A <input type="checkbox"/> B	Note 1	PASS
0.15 ~ 80	3	LAN	CDN-T8	<input checked="" type="checkbox"/> A <input type="checkbox"/> B	Note 1	PASS

EN 61000-6-2:

Frequency Band (MHz)	Field Strength (Vrms)	Cable	Injection Method	Performance Criterion	Observation	Result
0.15 ~ 80	10	Power Line	CDN-M3	<input checked="" type="checkbox"/> A <input type="checkbox"/> B	Note 1	PASS
0.15 ~ 80	10	LAN	CDN-T8	<input checked="" type="checkbox"/> A <input type="checkbox"/> B	Note 1	PASS

NOTE: 1. There was no change compared with initial operation during the test.



8.8. POWER FREQUENCY MAGNETIC FIELD

8.8.1. TEST SPECIFICATION

Basic Standard:	IEC 61000-4-8
Frequency Range:	50Hz, 60Hz
Field Strength:	EN 55024: 1 A/m EN 61000-6-2: 30 A/m
Observation Time:	1 minute
Inductance Coil:	Rectangular type, 1mx1m

8.8.2. TEST INSTRUMENT

Immunity Shield Room				
Name of Equipment	Manufacturer	Model	Serial Number	Calibration Due
TRIAX ELF Magnetic Field Meter	F.W.BELL	4090	9711	11/23/2010
Clamp Meter	National	300K	11-5980 K	11/23/2010
Magnetic Field Tester	HAEFELY TRENCH	MAG 100.1	080 938-01	06/04/2010

NOTE: 1. The calibration interval of the above test instruments is 12 months and the calibrations are traceable to NML/ROC and NIST/USA.
 2. N.C.R.= No Calibration required

8.8.3. TEST PROCEDURE (please refer to measurement standard or CCS SOP PA-027)

- a) The equipment was configured and connected to satisfy its functional requirements. It shall be placed on the GRP with the interposition of a 0.1m-thick insulating support.
- b. The equipment cabinets shall be connected to the safety earth directly on the GRP via the earth terminal of the EUT.
- c. The power supply, input and output circuits shall be connected to the sources of power supply, control and signal.
- d. The cables supplied or recommended by the equipment manufacturer shall be used. 1 meter of all cables used shall be exposed to the magnetic field.

8.8.4. TEST SETUP

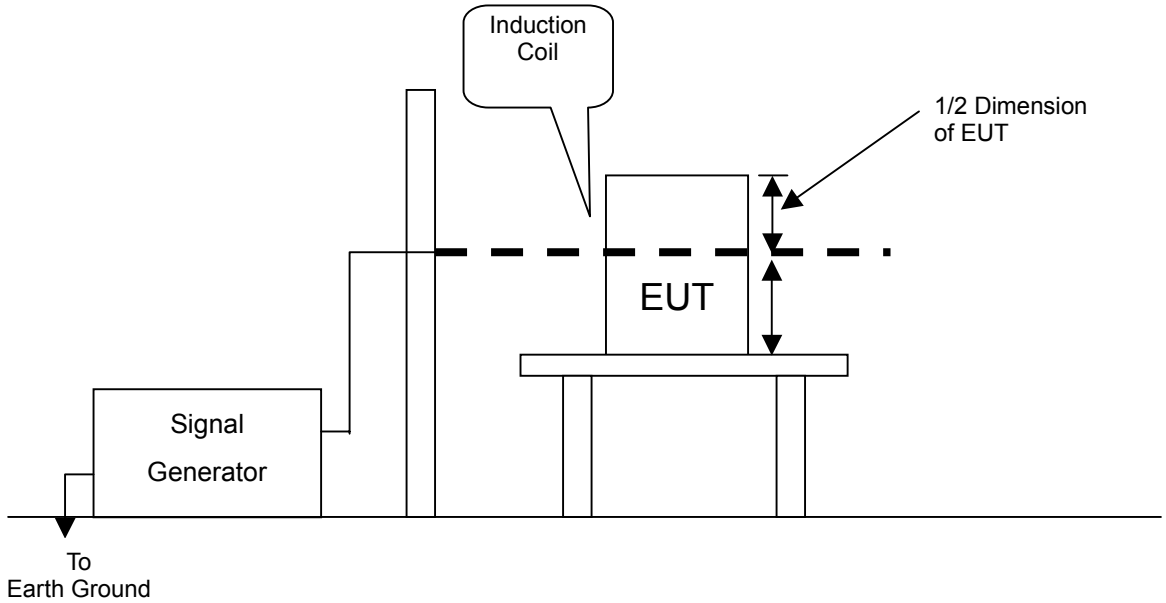

- For the actual test configuration, please refer to the related item – Photographs of the Test Configuration.

NOTE:

TABLETOP EQUIPMENT

The equipment shall be subjected to the test magnetic field by using the induction coil of standard dimension (1 m x 1 m). The induction coil shall then be rotated by 90 degrees in order to expose the EUT to the test field with different orientations.

FLOOR-STANDING EQUIPMENT

The equipment shall be subjected to the test magnetic field by using induction coils of suitable dimensions. The test shall be repeated by moving and shifting the induction coils, in order to test the whole volume of the EUT for each orthogonal direction. The test shall be repeated with the coil shifted to different positions along the side of the EUT, in steps corresponding to 50 % of the shortest side of the coil. The induction coil shall then be rotated by 90 degrees in order to expose the EUT to the test field with different orientations.



8.8.5. TEST RESULTS

Temperature	20, 21°C	Humidity	60, 59% RH
Pressure	996mbar	Tested By	Tony Tsai
Required Passing Performance	Criterion A		

For EN 55024:

DIRECTION	Field Strength (A/m)	Performance Criterion	Observation	Results
X	1	<input checked="" type="checkbox"/> A <input type="checkbox"/> B	Note 1	Pass
Y	1	<input checked="" type="checkbox"/> A <input type="checkbox"/> B	Note 1	Pass
Z	1	<input checked="" type="checkbox"/> A <input type="checkbox"/> B	Note 1	Pass

For EN 61000-6-2:

Direction	Field Strength (A/m)	Performance Criterion	Observation	Results
X	30	<input checked="" type="checkbox"/> A <input type="checkbox"/> B	Note 1	Pass
Y	30	<input checked="" type="checkbox"/> A <input type="checkbox"/> B	Note 1	Pass
Z	30	<input checked="" type="checkbox"/> A <input type="checkbox"/> B	Note 1	Pass

NOTE: 1. There was no change compared with the initial operation during the test.



8.9. VOLTAGE DIP & VOLTAGE INTERRUPTIONS

8.9.1. TEST SPECIFICATION

Basic Standard:	IEC 61000-4-11
Test duration time:	Minimum three test events in sequence
Interval between event:	Minimum 10 seconds
Angle:	0~360 degree
Step:	45 degree

8.9.2. TEST INSTRUMENT

Immunity shielded room				
Name of Equipment	Manufacturer	Model	Serial Number	Calibration Due
Dips/Interruption and Variations Simulator	HAEFELY TRENCH	PLINE 1610	080 344-05	04/29/2010
Test S/W	Winpats (3.25)			

NOTE: 1. The calibration interval of the above test instruments is 12 months and the calibrations are traceable to NML/ROC and NIST/USA.
 2. N.C.R.= No Calibration required

8.9.3. TEST PROCEDURE (please refer to measurement standard or CCS SOP PA-028)

1. The EUT and support units were located on a wooden table, 0.8 m away from ground floor.
2. Setting the parameter of tests and then perform the test software of test simulator.
3. Conditions changes to occur at 0 degree crossover point of the voltage waveform.
4. Recording the test result in test record form.
5. Removes the Battery Pack to test if any.

8.9.4. TEST SETUP

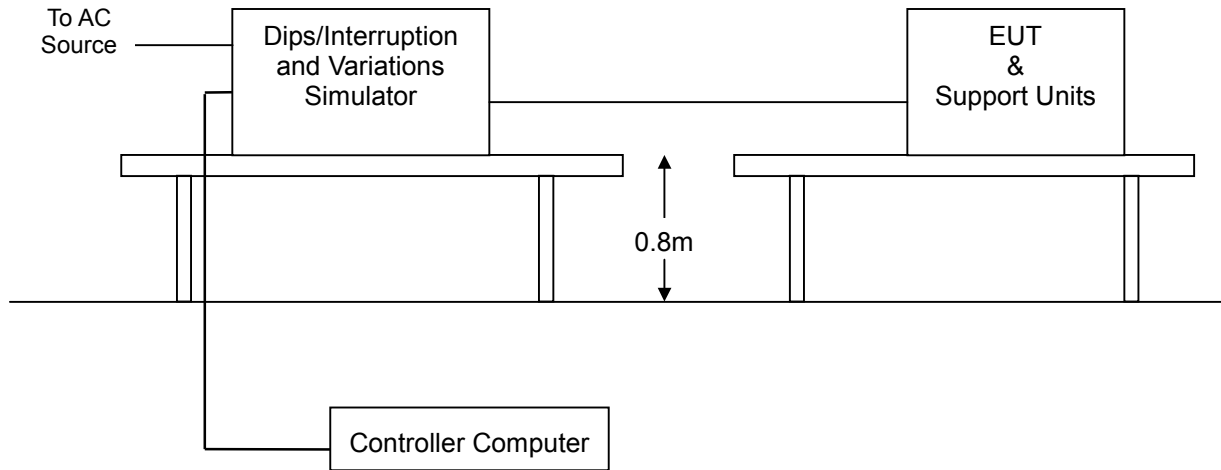

- For the actual test configuration, please refer to the related item – Photographs of the Test Configuration.



8.9.5. TEST RESULTS

Temperature	20, 21°C	Humidity	60, 59% RH
Pressure	992mbar	Tested By	Tony Tsai
Required Passing Performance	EN 55024: Criterion B: >95% reduction 0.5 period Criterion C: 30% reduction 25 period & >95% reduction 250 period EN 61000-6-2: Criterion B: 0% reduction 1 period Criterion C: 40% reduction 10/125 period, 50/60Hz & 70% reduction 25/30 period, 50/60Hz & 0% reduction 250/300 period, 50/60Hz		

EN 55024:

Test Power: 230Vac, 50Hz				
Voltage (% Reduction)	Duration (Period)	Performance Criterion	Observation	Test Result
>95	0.5	<input checked="" type="checkbox"/> A <input type="checkbox"/> B <input type="checkbox"/> C	Note 1	PASS
30	25	<input checked="" type="checkbox"/> A <input type="checkbox"/> B <input type="checkbox"/> C	Note 1	PASS
>95	250	<input type="checkbox"/> A <input type="checkbox"/> B <input checked="" type="checkbox"/> C	Note 2	PASS

EN 61000-6-2:

Test Power: 230Vac, 50Hz				
Voltage (% Reduction)	Duration (Period)	Performance Criterion	Observation	Test Result
0	1	<input checked="" type="checkbox"/> A <input type="checkbox"/> B <input type="checkbox"/> C	Note 1	PASS
40	10	<input checked="" type="checkbox"/> A <input type="checkbox"/> B <input type="checkbox"/> C	Note 1	PASS
70	25	<input checked="" type="checkbox"/> A <input type="checkbox"/> B <input type="checkbox"/> C	Note 1	PASS
0	250	<input type="checkbox"/> A <input type="checkbox"/> B <input checked="" type="checkbox"/> C	Note 2	PASS

- NOTE**
1. There was no change compared with initial operation during and after the test. No unintentional response was found during the test.
 2. The function stopped during the test, but can be recoverable manually after the test.

9 PHOTOGRAPHS OF THE TEST CONFIGURATION

CONDUCTED EMISSION TEST



**CONDUCTED EMISSION TEST AT TELECOMMUNICATION PORTS
RJ45 Telecom Port with ISN (10/100 Mbps and 1Gbps)**



**RADIATED EMISSION TEST
(Close Case)**



(Open Case)



POWER HARMONIC & VOLTAGE FLUCTUATION / FLICKER TEST



ELECTROSTATIC DISCHARGE TEST



RADIATED ELECTROMAGNETIC FIELD TEST



FAST TRANSIENTS/BURST TEST (POWER LINE)



SURGE IMMUNITY TEST



CONDUCTED DISTURBANCE, INDUCED BY RADIO-FREQUENCY FIELDS TEST (POWER LINE)



CONDUCTED DISTURBANCE, INDUCED BY RADIO-FREQUENCY FIELDS TEST (Injection Clamp)



POWER FREQUENCY MAGNETIC FIELD IMMUNITY TEST



VOLTAGE DIPS / INTERRUPTION TEST



PHOTOGRAPHS OF EUT

