

PCM-3353

**PC/104+ SBC w/AMD LX800,
VGA, LCD, LAN, USB2.0 and CF**

User Manual

Copyright

This document is copyrighted, © 2006. All rights are reserved. The original manufacturer reserves the right to make improvements to the products described in this manual at any time without notice.

No part of this manual may be reproduced, copied, translated or transmitted in any form or by any means without the prior written permission of the original manufacturer. Information provided in this manual is intended to be accurate and reliable. However, the original manufacturer assumes no responsibility for its use, nor for any infringements upon the rights of third parties that may result from such use.

Acknowledgements

Award is a trademark of Award Software International, Inc.

VIA is a trademark of VIA Technologies, Inc.

IBM, PC/AT, PS/2 and VGA are trademarks of International Business Machines Corporation.

Intel, Pentium, Celeron, and MMX are registered trademarks of Intel Corporation.

Microsoft Windows[®] is a registered trademark of Microsoft Corp.

RTL is a trademark of Realtek Semi-Conductor Co., Ltd.

ESS is a trademark of ESS Technology, Inc.

UMC is a trademark of United Microelectronics Corporation.

SMI is a trademark of Silicon Motion, Inc.

Creative is a trademark of Creative Technology LTD.

All other product names or trademarks are properties of their respective owners.

For more information on this and other products, please visit our websites at:
<http://www.emacinc.com>

For technical support and service, please visit our support website at:
<http://www.emacinc.com/support>

This manual is for the PCM-3353.

Part No. 2006335311

2nd Edition

Printed in Taiwan

June 2008

Packing List

Before you begin installing your card, please make sure that the following materials have been shipped:

- 1 x PCM-3353 SBC
- 1 x Power cable
- 1 x Audio cable
- 1 x Four COM cable
- 1 x Keyboard/Mouse cable
- 1 x Y cable (for KB/MS extension)
- 1 x Ethernet RJ-45 Conn. conversion cable
- 1 x LPT port cable
- 1 x IDE cable
- 1 x VGA cable
- 2 x USB cable (bracket type with two USB ports)
- 1 x Startup manual (Optional)
- 1 x CD-ROM (Optional)

If any of these items are missing or damaged, contact your distributor or sales representative immediately.

Model No. List	Description
PCM-3353F-L	PC/104+ SBC w/AMD LX800, VGA, LVDS, LAN, USB and CF
PCM-3353Z-L	PCM-3353F-L with Phoenix Gold package
PCM-3353Z2-L	PCM-3353F-L with Phoenix Platinum package

Additional Information and Assistance

1. Visit the our web site at **www.emacinc.com** where you can find the latest information about the product.
2. Contact your distributor, sales representative, or customer service center for technical support if you need additional assistance.

Please have the following information ready before you call:

- Product name and serial number
- Description of your peripheral attachments
- Description of your software (operating system, version, application software, etc.)
- A complete description of the problem
- The exact wording of any error messages

FCC

This device complies with the requirements in part 15 of the FCC rules: Operation is subject to the following two conditions:

- 1. This device may not cause harmful interference, and*
- 2. This device must accept any interference received, including interference that may cause undesired operation*

This equipment has been tested and found to comply with the limits for a Class A digital device, pursuant to Part 15 of the FCC Rules. These limits are designed to provide reasonable protection against harmful interference when the equipment is operated in a commercial environment. This equipment generates, uses, and can radiate radio frequency energy and, if not installed and used in accordance with the instruction manual, may cause harmful interference to radio communications. Operation of this device in a residential area is likely to cause harmful interference in which case the user will be required to correct the interference at his/her own expense. The user is advised that any equipment changes or modifications not expressly approved by the party responsible for compliance would void the compliance to FCC regulations and therefore, the user's authority to operate the equipment.



Achtung!

There is a danger of a new battery exploding if it is incorrectly installed. Do not attempt to recharge, force open, or heat the battery. Replace the battery only with the same or equivalent type recommended by the manufacturer. Discard used batteries according to the manufacturer's instructions

Contents

Chapter 1	Introduction	2
1.1	Introduction	2
1.2	Features	2
1.3	Specifications	2
1.3.1	Standard PC/104 H-EBX SBC Functions.....	2
1.3.2	VGA/LVDS Interface	3
1.3.3	Ethernet Interface.....	3
1.3.4	Audio Function	3
1.3.5	OS support	3
1.3.6	Mechanical and Environmental	4
1.4	Board layout: dimensions.....	5
	Figure 1.2:Board layout: Dimensions (Solder Side).....	6
Chapter 2	Installation	8
2.1	Jumpers.....	8
	Table 2.1:Jumper/Switch Setting:.....	8
2.2	Connectors.....	8
	Table 2.2:Connector Table:	8
2.3	Locating Connectors	10
	Figure 2.1:Connectors (component side).....	10
	Figure 2.2:Connectors (solder side).....	10
2.4	Setting Jumpers	11
2.5	Installing SO-DIMMs	12
2.6	IDE, CDROM hard drive connector (CN11)	12
2.6.1	Connecting the hard drive.....	12
2.7	Solid State Disk.....	13
2.7.1	Compact Flash (CN41).....	13
2.8	Parallel port connector (CN19).....	13
2.9	Keyboard and PS/2 mouse connector (CN18)	13
2.10	Power connectors (CN38)	13
2.10.1	Main power connector, +5 V, +12 V (CN38).....	13
2.10.2	Power Reset button.....	13
2.11	Audio interfaces (CN34/35).....	14
2.11.1	Audio connector Audio-out(CN35), Audio-in(CN34) .	14
2.12	COM port connector (CN20,CN30).....	14
2.12.1	Serial Port RS-422/485 (CN20).....	14
	Table 2.3:Serial Port RS-422/485 (CN39).....	14
2.13	VGA/LCD interface connections	14
2.13.1	CRT display connector (CN27).....	14
2.13.2	TTL TFT LCD connector (CN4).....	14
2.13.3	LVDS TFT LCD connector (CN42).....	15

2.14	Ethernet configuration.....	15
2.14.1	100Base-T connector (CN26).....	15
2.15	Watchdog timer configuration	15
2.16	USB connectors (CN15,CN17).....	15
2.17	GPIO (General Purpose Input Output) (CN36/CN37)....	16
Chapter 3	Award BIOS Setup.....	18
3.1	Introduction	18
3.1.1	CMOS RAM Auto-backup and Restore	18
3.2	Entering Setup	19
	Figure 3.1:Award BIOS Setup initial screen	19
3.3	Standard CMOS Setup	20
3.4	Standard CMOS Setup	20
3.5	Advanced BIOS Features	20
	Figure 3.2:Advanced BIOS features screen.....	21
3.5.1	Virus Warning.....	21
3.5.2	First/Second/Third/Other Boot Device.....	21
3.5.3	Boot Up NumLock Status.....	21
3.5.4	Gate A20 Option.....	21
3.5.5	Typematic Rate Setting.....	21
3.5.6	Typematic Rate (Chars/Sec).....	22
3.5.7	Typematic Delay (msec).....	22
3.5.8	Security Option	22
3.6	Integrated Peripherals.....	22
3.6.1	IDE Master/Slave PIO/UDMA Mode.....	22
3.6.2	Integrated peripherals screen	23
3.6.3	Onboard LAN Control	23
3.6.4	IDE HDD Block Mode	23
3.6.5	Onboard Serial Port	23
3.6.6	Onboard Parallel Port.....	23
3.6.7	Parallel Port Mode	23
3.6.8	EPP Mode Select	24
3.6.9	ECP Mode Use DMA	24
3.7	Power Management Setup.....	24
	Figure 3.3:Power management setup screen.....	24
3.7.1	ACPI function	24
3.7.2	Power Management	24
3.7.3	Video Off In Suspend	25
3.7.4	Modem Use IRQ.....	25
3.7.5	HDD Power Down.....	25
3.7.6	PowerOn By Modem	25
3.7.7	PowerOn By Alarm	25
3.7.8	Primary IDE 0 (1) and Secondary IDE 0 (1)	25
3.7.9	FDD, COM, LPT PORT	25
3.7.10	PCI PIRQ [A-D]#	25

3.8	PnP/PCI Configurations	26
3.8.1	PnP OS Installed	26
	Figure 3.4:PnP/PCI configurations screen.....	26
3.8.2	Reset Configuration Data.....	26
3.8.3	Resources controlled by:.....	26
3.8.4	PCI/VGA Palette Snoop	26
3.9	PC Health Status.....	27
3.9.1	PC Health Status Screen	27
3.10	Password Setting	27
3.11	Save & Exit Setup	28
3.12	Exit Without Saving	28
Chapter 4	PCI SVGA/LCD Setup	30
4.1	Introduction	30
4.1.1	Display type	30
4.1.2	Dual Simultaneous Display	30
4.1.3	CMOS setting for panel type	30
4.2	Connections to Two Standard LCDs.....	31
4.2.1	AMD Geode LX	31
	Table 4.1:Connections to Sharp LQ121S1DG31 / PCM-3353	31
4.3	Installation of the SVGA Driver	32
4.3.1	Installation chipset AES driver	33
4.3.2	Installation of VGA driver.....	36
4.3.3	PCI Bridge	40
4.4	Further Information	42
Chapter 5	Audio Setup.....	44
5.1	Introduction	44
5.2	Driver installation.....	44
5.2.1	Before you begin.....	44
5.2.2	Windows XP drivers	45
Chapter 6	Ethernet Interface	50
6.1	Introduction	50
6.2	Installation of Ethernet driver	50
6.2.1	Installation for Windows XP	51
6.3	Further information	56
Appendix A	Pin Assignments	58
A.1	Jumper and Connector Tables	58
	Table A.1:SW1, CF Master / Slave Selector	58
	Table A.2:J3, Clear CMOS.....	58
	Table A.3:CN39, COM2 Setting	59
	Table A.4:J5, PCI VI/O POWER	59
	Table A.5:CN42, LVDS LCD I/F.....	60

Table A.6:CN38, Power Input	60
Table A.7:CN4, TFT LCD I/F	61
Table A.8:CN5, Inverter Power.....	63
Table A.9:CN6, SMBus.....	63
Table A.10:CN32, Reset / Buzzer pin header.....	64
Table A.11:CN36, GPIO1	64
Table A.12:CN37, GPIO2	65
Table A.13:CN11, IDE	65
Table A.14:CN27, CRT	67
Table A.15:CN15, USB1/2.....	67
Table A.16:CN17, USB3/4.....	68
Table A.17:CN30, COM1/2/3/4	69
Table A.18:CN19, Print Port	71
Table A.19:CN20, RS422/485.....	72
Table A.20:CN35, AUDIO-OUT	72
Table A.21:CN34, AUDIO-IN	73
Table A.22:CN23, ISA -5V & -12V Input	73
Table A.23:CN26, LAN1.....	74
Table A.24:CN18, KB/MS	74
Table A.25:CN40, DDR RAM SOCKET.....	75
Table A.26:CN41, CF SOCKET	75
Appendix B System Assignments	78
B.1 System I/O Ports.....	78
Table B.1:System I/O ports	78
B.2 1st MB memory map.....	79
Table B.2:1st MB memory map	79
B.3 DMA channel assignments.....	79
Table B.3:DMA channel assignments	79
B.4 Interrupt assignments	80
Table B.4:Interrupt assignments	80
Appendix C Mechanical Drawings.....	82
C.1 Mechanical Drawings.....	82
Figure C.1:PCM-3353 Mech Drawing (Comp Side)....	82
Figure C.2:PCM-3353 Mech Drawing (Sol Side)	82

General Information

This chapter gives background information on the PCM-3353.

Sections include:

- Introduction
- Features
- Specifications
- Board layout and dimensions

Chapter 1 Introduction

1.1 Introduction

The PCM-3353 is a fanless, best-cost, performance PC/104+ SBC (Single Board Computer) geared to satisfy the needs for various industrial computing equipment. PCM-3353 is ideal for communication, gaming and medical applications that require flat panel support using digital displays with TTL and LVDS interfaces and single Ethernet ports.

For those who want superior performance for various low-power embedded applications, PCM-3353 uses an AMD LX-800 processor clocked at 500 MHz, in conjunction with onboard DDR333 system memory.

PCM-3353 offers convenient connector layout, easy assembly, multiple I/O, and includes single 10/100Mbps Ethernet, four USB (Universal Serial Bus) 2.0 and four serial ports for easy system expansibility.

1.2 Features

- AMD low power LX800 500MHz Processor
- Supports DDR memory
- Supports 24-bit TFT LCD interface
- Supports 18-bit LVDS interface
- Supports 1 x 100Base-T Fast Ethernet
- Supports Four USB2.0 ports
- Supports Four COM ports
- PC/104+ expansion interface

1.3 Specifications

1.3.1 Standard PC/104 Half-EBX SBC Functions

- **CPU:** AMD Geode® LX800 processor, up to 500 MHz
- **System Memory:** Onboard Memory, support Double Data Rate (DDR) SDRAM, accept 128/256 MB, DDR333 SDRAM
- **2nd Cache Memory:** 128 KB on the processor
- **System Chipset:** AMD Geode LX800

- **BIOS:** AWARD 4Mbit Flash BIOS
- **Watchdog timer:** 255 levels timer interval
- **Expansion Interface:** PC/104+
- **Battery:** Lithium 3V/196 mAh
- **Power management:** ACPI supported
- **Enhanced IDE interface:** One channel supports up to two EIDE devices. BIOS auto-detect, PIO Mode 3 or Mode 4, supports UDMA 33/66 mode
- **Serial ports:** Four serial RS-232 ports in one 40 pin connector (CN30: COM1/2/3/4). RS-422 and RS-485 in one pinheader (CN20) and can be configured via CN39 connector.
- **Parallel port:** One parallel port, supports SPP/EPP/ECP mode
- **Keyboard/mouse connector:** Supports one standard PC/AT keyboard and a PS/2 mouse
- **Audio:** Supports AC97 Audio stereo sound
- **USB:** Four USB 2.0 ports compliant universal serial bus ports
- **CF:** Solid State Disk (SSD) supports one 50-pin socket for CFC type I (type II optional)

1.3.2 VGA/LVDS Interface

- **Chipset:** AMD Geode LX800
- **Memory Size:** Optimized Shared Memory Architecture, supports 64 MB frame buffer using system memory
- **Resolution:** CRT resolution: up to 1600 x 1200 x 16 bpp at 100 Hz and up to 1024 x 768 x 32 bpp at 60 Hz for TFT LCD
- **LCD Interface:** Supports up to 24-bit TFT LCD (TTL signal)
Supports 18-bit LVDS LCD
- **Dual Simultaneous Display:** CRT + LCD, CRT + LVDS

1.3.3 Ethernet Interface

- **Chipset supports:** 1 x 10/100 Mbps - Intel 82551ER
- **Interface:** 1 x internal box header
- Standard IEEE 802.3u (100 BASE-T) protocol compatible

1.3.4 Audio Function

- **Audio controller:** Realtek ACL202/ACL650 chipset, supports AC97 3D Audio stereo sound
- **Audio interface:** Microphone in, Line in, Line out

1.3.5 OS support

- This board supports Win XP, Win CE and Win XPe.

- For further information about OS support in your PCM-3353, visit the following web resource website: www.emacinc.com or please contact technical support center

1.3.6 Mechanical and Environmental

- **Dimensions:** 96 x 115 mm (3.77"x 4.05")
Mechanical Drawing (dxf file) is available.
- **Power Supply Type:** AT
- **Power Requirement:** +5 V \pm 5%, +12 V \pm 5% (Optional), (5V only, 12V optional for PC104 add on card and LCD inverter)
- **Power Consumption:**
(Geode LX800, 256 MB DDR333)
Max: +5 V @ 1.51 A, +12 V @ 0.1 A
Typical: +5 V @ 1.35 A, +12 V @ 0.1A
- **Operating temperature:** 0 ~ 60°C (32 ~ 140°F)
- **Operating Humidity:** 10% ~ 90% relative humidity, non-condensing
- **Weight:** 0.85 kg (reference weight of total package)

1.4 Board layout: dimensions

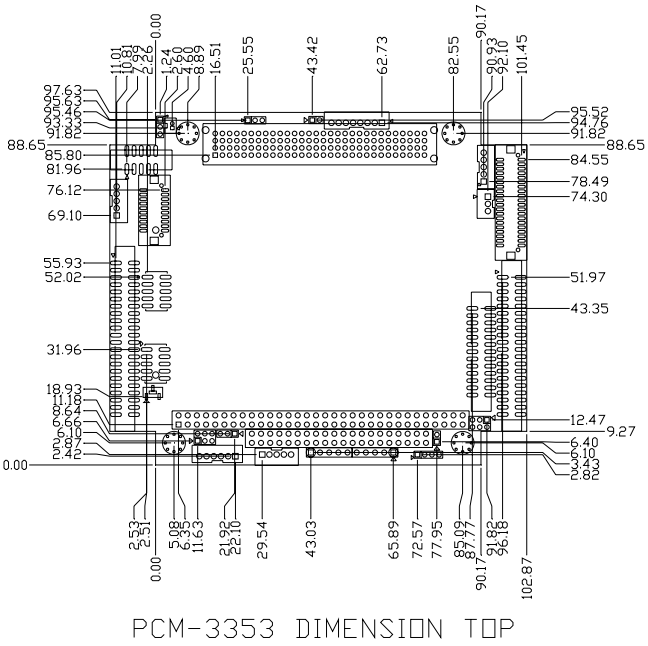
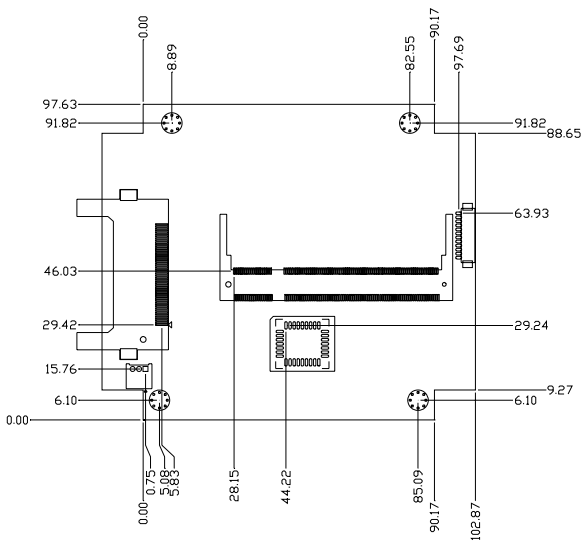

Figure 1.1: Board layout: Dimensions (Component Side)



PCM-3353 DIMENSION BOT

Figure 1.2: Board layout: Dimensions (Solder Side)

Installation

This chapter explains the setup procedures of the PCM-3353 hardware, including instructions on setting jumpers and connecting peripherals, switches and indicators. Be sure to read all safety precautions before you begin the installation procedure.

Chapter 2 Installation

2.1 Jumpers

The PCM-3353 has a number of jumpers that allow you to configure your system to suit your application. The table below lists the functions of the various jumpers.

Table 2.1: Jumper/Switch Setting:

J3	Clear CMOS
J5	PCI VI/O Power Selector
CN39	COM2 Setting
SW1	CF Master / Slave Selector

2.2 Connectors

Onboard connectors link the PCM-3353 to external devices such as hard disk drives, a keyboard, or floppy drives. The table below lists the function of each of the board's connectors.

Table 2.2: Connector Table:

CN4	TFT LCD I/F
CN5	Inverter Power
CN6	SMBus
CN11	IDE
CN15	USB1/2 / CN17 USB 3/4
CN18	KB/MS
CN19	Print Port
CN20	RS422/485
CN23	ISA -5V & -12V Input
CN26	LAN
CN27	CRT
CN30	COM1/2/3/4
CN32	Reset / Buzzer pin header
CN35	AUDIO-OUT / CN34 AUDIO-IN
CN36	GPIO1 / CN37 GPIO2
CN38	Power Input
CN40	DDR RAM Socket
CN41	CF Socket

CN42	LVDS LCD I/F
CN43	Inverter Power (LVDS)

2.3 Locating Connectors

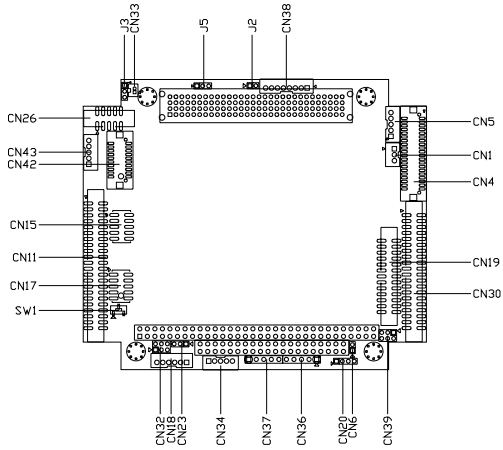

PCM-3353 POSITION TOP

Figure 2.1: Connectors (component side)

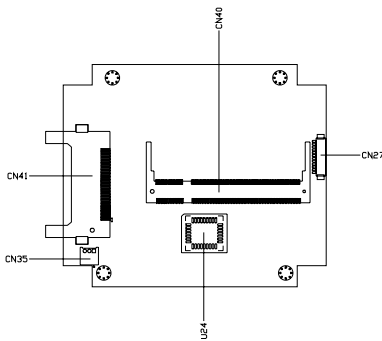

PCM-3353 POSITION BOT

Figure 2.2: Connectors (solder side)

2.4 Setting Jumpers

You may configure your card to match the needs of your application by setting jumpers. A jumper is a metal bridge used to close an electric circuit. It consists of two metal pins and a small metal clip (often protected by a plastic cover) that slides over the pins to connect them. To “close” a jumper, you connect the pins with the clip. To “open” a jumper, you remove the clip. Sometimes a jumper will have three pins, labeled 1, 2 and 3. In this case you would connect either pins 1 and 2, or 2 and 3.

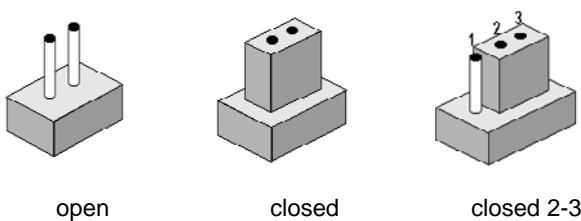

The jumper settings are schematically depicted in this manual as follows:

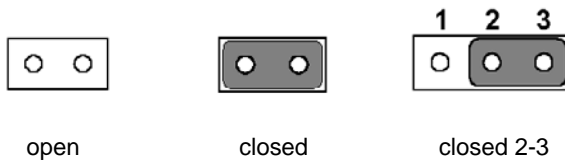

A pair of needle-nose pliers may be helpful when working with jumpers. If you have any doubts about the best hardware configuration for your application, contact your local distributor or sales representative before you make any changes. Generally, you simply need a standard cable to make most connections.

2.5 Installing SO-DIMMs

The procedures for installing SODIMMs are described below. Please follow these steps carefully. You can install SDRAM memory modules using 200-pin SODIMMs (Small Outline Dual In-line Memory Modules).

1. Ensure that all power supplies to the system are switched off.
2. Tilt the SODIMM card just above the board and slide it into the housing card slot.
3. Push the module into the socket until the module gently snaps in. There should only be a slight insertion force to engage the module into the contacts. Make sure that the module and the housing are aligned and locked in place.

2.6 IDE, CDROM hard drive connector (CN11)

The board provides 1 IDE channel which you can attach up to two Enhanced Integrated Drive Electronics hard disk drives or CDROM to the board's internal controller. Its IDE controller uses a PCI interface. This advanced IDE controller supports faster data transfer, PIO mode 3, mode 4 and up to UDMA 33/66.

2.6.1 Connecting the hard drive

Connecting drives is done in a daisy-chain fashion. This package includes One 44 PIN IDE cable that can connect to 1.8" and 2.5" drives.

1. Connect one end of the cable to Hard Drive connector. Make sure that the red (or blue) wire corresponds to pin 1 on the connector, which is labeled on the board (on the right side).
2. Plug the other end of the cable into the Enhanced IDE hard drive, with pin 1 on the cable corresponding to pin 1 on the hard drive. (See your hard drive's documentation for the location of the connector.)

If desired, connect a second drive as described above.

Unlike floppy drives, IDE hard drives can connect to either end of the cable. If you install two drives, you will need to set one as the master and one as the slave by using jumpers on the drives. If you install only one drive, set it as the master.

2.7 Solid State Disk

The board provides a CompactFlash card type I socket and type II for optional kit.

2.7.1 Compact Flash (CN41)

The CompactFlash card shares a secondary IDE channel which can be enabled/disabled via the BIOS settings.

2.8 Parallel port connector (CN19)

Normally, the parallel port is used to connect the cable to a printer. The board includes a multi-mode (ECP/EPP) parallel port accessed via CN19 and a 26-pin flat-cable connector. You will need an adapter cable if you use a traditional DB-25 connector. The adapter cable has a 26-pin connector on one end, and a DB-25 connector on the other.

The parallel port is designated as LPT1, and can be disabled or changed to LPT2 or LPT3 in the system BIOS setup.

The parallel port interrupt channel is designated to be IRQ7.

You can select ECP/EPP/ECP DMA channel via BIOS setup.

2.9 Keyboard and PS/2 mouse connector (CN18)

The board provides a keyboard connector that supports both a keyboard and a PS/2 style mouse. In most cases, especially in embedded applications, a keyboard is not used. If the keyboard is not present, the standard PC/AT BIOS will report an error or fail during power-on self-test (POST) after a reset. The PCM 3353's BIOS standard setup menu allows you to select "All, But Keyboard" under the "Halt On" selection. This allows no-keyboard operation in embedded system applications, without the system halting under POST.

2.10 Power connectors (CN38)

2.10.1 Main power connector, +5 V, +12 V (CN38)

Supplies main power +5V to the PCM-3353, and to devices that require +12 V.

2.10.2 Power Reset button

Momentarily pressing the reset button will activate a reset. The switch should be rated for 10 mA, 5 V.

2.11 Audio interfaces (CN34/35)

2.11.1 Audio connector Audio-out(CN35), Audio-in(CN34)

The board provides all major audio signals on a 8-pin cable connector, These audio signals include Microphone in (mono), Line in (stereo) and Line out (stereo).

2.12 COM port connector (CN20,CN30)

The board provides four serial ports: Four serial RS-232 ports in one 40 pin connector (CN30: COM1/2/3/4). It provides connections for serial devices or a communication network. You can find the pin assignments for the COM port connector in Appendix C.

2.12.1 Serial Port RS-422/485 (CN20)

Serial port can be configured to operate in RS-422 and RS-485 mode. RS-422 and RS-485 in one pinheader (CN20) and can be configured via CN39 connector.

Table 2.3: Serial Port RS-422/485 (CN39)

Setting	Function
1-2	RS-232
3-4	RS-485
5-6	RS-422

2.13 VGA/LCD interface connections

The board's PCI SVGA interface can drive conventional CRT displays and is capable of driving a wide range of flat panel displays.

2.13.1 CRT display connector (CN27)

The CRT display connector is a 15-pin D-SUB connector used for conventional CRT displays.

2.13.2 TTL TFT LCD connector (CN4)

For PCM-3353 series, CN4 consists of a 40-pin connector which can support up to 24-bit LCD panel. It is Hirose's product no. DF13A-40DP-1.25 V

2.13.3 LVDS TFT LCD connector (CN42)

Four PCM-3353 series, the board supports 1 channel 18-bit LVDS LCD panel displays.

2.14 Ethernet configuration

The board is equipped with one high performance 32-bit PCI-bus Ethernet interface which are fully compliant with IEEE 802.3U 10/100Mbps standards. They are supported by all major network operating systems.

2.14.1 100Base-T connector (CN26)

100Base-T connections are made via one internal 10-pin box header.

2.15 Watchdog timer configuration

An onboard watchdog timer reduces the chance of disruptions which EMP (electro-magnetic pulse) interference can cause. This is an invaluable protective device for standalone or unmanned applications. Setup involves one jumper and running the control software (refer to Appendix A).

2.16 USB connectors (CN15,CN17)

The board provides up to four USB (Universal Serial Bus) ports using Plug and Play. The USB interfaces comply with High Speed USB specification Rev. 2.0 which supports 480 Mbps transfer rate, and are fuse protected.

The USB interface is accessed through two 5 x 2-pin flat-cable connectors. You will need an adapter cable if you use a standard USB connector. The adapter cable has a 5 x 2-pin connector on one end and a USB connector on the other.

The USB interfaces can be disabled in the system BIOS setup.

2.17 GPIO (General Purpose Input Output) (CN36/ CN37)

The board supports 8-bit GPIO through GPIO connector. The 8 digital inputs and outputs can be programmed to read or control devices, with each input or output defined. The default setting is 8 bits input.

CHAPTER
3

Award BIOS Setup

Chapter 3 Award BIOS Setup

3.1 Introduction

Award's BIOS ROM has a built-in setup program that allows users to modify the basic system configuration. This type of information is stored in battery-backed memory (CMOS RAM) so that it retains the setup information when the power is turned off.

3.1.1 CMOS RAM Auto-backup and Restore

The CMOS RAM is powered by an onboard button cell battery. When you finish BIOS setup, the data in CMOS RAM will be automatically backed up to Flash ROM. If operation in harsh industrial environments causes a software error, the BIOS will recheck the data in CMOS RAM and automatically restore the original data in Flash ROM to CMOS RAM for booting.

Note: If you intend to change the CMOS setting without restoring the previous backup, you have to click on "DEL" within two seconds of the "CMOS checksum error..." display screen message appearing. Then enter the "Setup" screen to modify the data. If the "CMOS checksum error..." message appears again and again, please check to see if you need to replace the battery in your system.

3.2 Entering Setup

Turn on the computer and check for the “patch code”. If there is a number assigned to the patch code, it means that the BIOS supports your CPU.

If there is no number assigned to the patch code, please contact our applications engineers to obtain an up-to-date patch code file. This will ensure that your CPU’s system status is valid. After ensuring that you have a number assigned to the patch code, press to allow you to enter the setup.



Figure 3.1: Award BIOS Setup initial screen

3.3 Standard CMOS Setup

Choose the “Standard CMOS Features” option from the “Initial Setup Screen” menu, and the screen below will be displayed. This menu allows users to configure system components such as date, time, hard disk drive, Video, Halt On, display, and memory.

3.4 Standard CMOS Setup



3.5 Advanced BIOS Features

The “Advanced BIOS Features” screen appears when choosing the “Advanced BIOS Features” item from the “Initial Setup Screen” menu. It allows the user to configure the board according to his particular requirements. Below are some major items that are provided in the Advanced BIOS Features screen. A quick booting function is provided for your con-

venience. Simply enable the Quick Booting item to save yourself valuable time.



Figure 3.2: Advanced BIOS features screen

3.5.1 Virus Warning

If enabled, a warning message and alarm beep activates if someone attempts to write here. The commands are “Enabled” or “Disabled.”

3.5.2 First/Second/Third/Other Boot Device

The BIOS tries to load the OS with the devices in the sequence selected.

Choices are: HDD, CDROM, LAN, Disabled.

3.5.3 Boot Up NumLock Status

This feature selects the “power on” state for NumLock. The commands are “Enabled” or “Disabled.”

3.5.4 Gate A20 Option

Normal: A pin in keyboard controller controls GateA20

Fast (Default): Chipset controls GateA20.

3.5.5 Typematic Rate Setting

The typematic rate is the rate key strokes repeat as determined by the keyboard controller. The commands are “Enabled” or “Disabled.” Enabling allows the typematic rate and delay to be selected.

3.5.6 Typematic Rate (Chars/Sec)

BIOS accepts the following input values (characters/second) for typematic rate: 6, 8, 10, 12, 15, 20, 24, 30.

3.5.7 Typematic Delay (msec)

Typematic delay is the time interval between the appearance of two consecutive characters, when holding down a key. The input values for this category are: 250, 500, 750, 1000 (msec).

3.5.8 Security Option

This setting determines whether the system will boot up if the password is denied. Access to Setup is always limited.

System The system will not boot, and access to Setup will be denied if the correct password is not entered at the prompt.

Setup The system will boot, but access to Setup will be denied if the correct password is not entered at the prompt.

Note: To disable security, select "PASSWORD SETTING" in the main menu. At this point, you will be asked to enter a password. Simply press <Enter> to disable security. When security is disabled, the system will boot, and you can enter Setup freely.

3.6 Integrated Peripherals

3.6.1 IDE Master/Slave PIO/UDMA Mode,

IDE Master/Slave PIO/UDMA Mode (Auto) has a master and a slave, making two IDE devices possible. Because each IDE device may have a different Mode timing (0, 1, 2, 3, 4), it is necessary for these to be independent. The default setting "Auto" will allow auto detection to ensure optimal performance.

3.6.2 Integrated peripherals screen

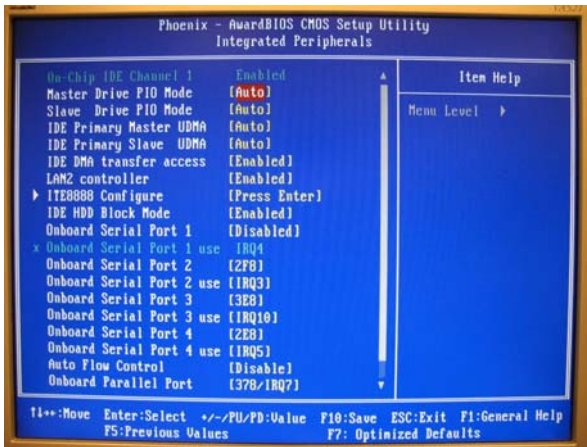

3.6.3 Onboard LAN Control

Options are Enable or Disable. Select Disable if user does not want to use onboard LAN controller1

3.6.4 IDE HDD Block Mode

You can enable the Primary IDE channel and/or the Secondary IDE channel. Any channel not enabled is disabled. This field is for systems with only SCSI drives.

3.6.5 Onboard Serial Port

For settings reference the Appendix for the serial resource allocation, and Disabled for the on-board serial connector

3.6.6 Onboard Parallel Port

This field sets the address of the onboard parallel port connector. You can select either 3BCH/IRQ7, 378H/IRQ7, 278H/IRQ5 or Disabled. If you install an I/O card with a parallel port, make sure there is no conflict in the address assignments. The CPU card can support up to three parallel ports, as long as there are no conflicts for each port.

3.6.7 Parallel Port Mode

This field allows you to set the operation mode of the parallel port. The setting “Normal” allows normal speed operation, but in one direction only. “EPP” allows bidirectional parallel port operation at maximum speed. “ECP” allows the parallel port to operate in bi-directional mode and at a speed faster than the maximum data transfer rate. “ECP + EPP” allows normal speed operation in a two-way mode.

3.6.8 EPP Mode Select

This field allows you to select EPP port type 1.7 or 1.9.

3.6.9 ECP Mode Use DMA

This selection is available only if you select “ECP” or “ECP + EPP” in the Parallel Port Mode field. In ECP Mode Use DMA, you can select DMA channel 1, DMA channel 3, or Disable. Leave this field on the default setting.

3.7 Power Management Setup

The power management setup controls the CPU card’s “green” features to save power. The following screen shows the manufacturer’s defaults:



Figure 3.3: Power management setup screen

3.7.1 ACPI function

The choice: Enabled, Disabled.

3.7.2 Power Management

This category allows you to select the type (or degree) of power saving and is directly related to the following modes:

1. HDD Power Down
2. Suspend Mode

There are four selections for Power Management, three of which have fixed mode settings

Min. Power Saving	Minimum power management., Suspend Mode = 1 hr., and HDD Power Down = 15 min.
Max. Power Saving	Maximum power management., Suspend Mode = 1 min., and HDD Power Down = 1 min.
User Defined (Default)	Allows you to set each mode individually. When not disabled, each of the ranges are from 1 min. to 1 hr. except for HDD Power Down which ranges from 1 min. to 15 min. and disable.

3.7.3 Video Off In Suspend

When system is in suspend, video will turn off.

3.7.4 Modem Use IRQ

This determines the IRQ which the MODEM can use. The choices: 3, 4, 5, 7, 9, 10, 11, NA.

3.7.5 HDD Power Down

You can choose to turn the HDD off after one of the time intervals listed, or when the system is in “suspend” mode. If the HDD is in a power saving mode, any access to it will wake it up.

3.7.6 PowerOn By Modem

When Enabled, an input signal on the serial Ring Indicator (RI) line (in other words, an incoming call on the modem) awakens the system from a soft off state. The choices: Enabled, Disabled.

3.7.7 PowerOn By Alarm

When Enabled, you can set the date and time at which the RTC (real-time clock) alarm awakens the system from Suspend mode. The choices: Enabled, Disabled.

3.7.8 Primary IDE 0 (1) and Secondary IDE 0 (1)

When Enabled, the system will resume from suspend mode if Primary IDE 0 (1) or Secondary IDE 0 (1) is active. The choices are: Enabled, Disabled.

3.7.9 FDD, COM, LPT PORT

When Enabled, the system will resume from suspend mode if FDD, COM port, or LPT port is active. The choice: Enabled, Disabled.

3.7.10 PCI PIRQ [A-D]#

When Enabled, the system will resume from suspend mode if an interrupt occurs. The choices are: Enabled, Disabled.

3.8 PnP/PCI Configurations

3.8.1 PnP OS Installed

Select Yes if you are using a plug and play capable operating system.
Select No if you need the BIOS to configure non-boot device



Figure 3.4: PnP/PCI configurations screen

3.8.2 Reset Configuration Data

Default is Disable. Select Enable to reset Extended System Configuration Data (ESCD) if you have installed a new add-on and system configuration has caused such a conflict that OS cannot boot.

3.8.3 Resources controlled by:

The commands here are “Auto” or “Manual.” Choosing “manual” requires you to choose resources from each following sub-menu. “Auto” automatically configures all of the boot and Plug and Play devices but you must be using Windows 95 or above.

3.8.4 PCI/VGA Palette Snoop

This is left at “Disabled.”

3.9 PC Health Status

This is to check the PC health, e.g.: current CPU temperature.

3.9.1 PC Health Status Screen

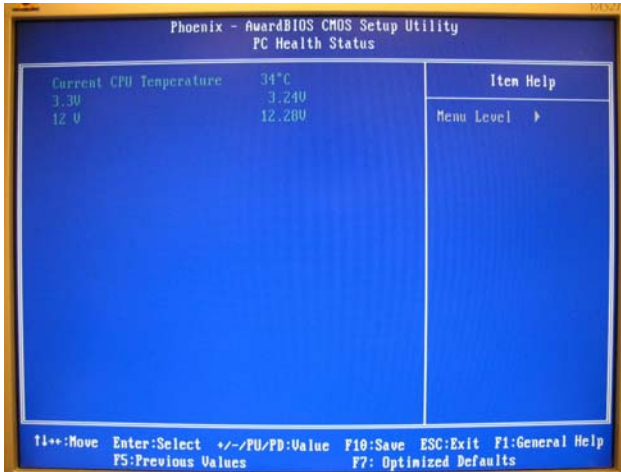

3.10 Password Setting

To change the password:

1. Choose the "Set Password" option from the "Initial Setup Screen" menu and press <Enter>.

The screen will display the following message

Please Enter Your Password

Press <Enter>.

2. If the CMOS is good or if this option has been used to change the default password, the user is asked for the password stored in the CMOS. The screen will display the following message:

Please Confirm Your Password

Enter the current password and press <Enter>.

3. After pressing <Enter> (ROM password) or the current password (user-defined), you can change the password stored in the CMOS. The password must be no longer than eight (8) characters.

Remember, to enable the password setting feature, you must first select either “Setup” or “System” from the “Advanced BIOS Features” menu.

3.11 Save & Exit Setup

If you select this and press <Enter>, the values entered in the setup utilities will be recorded in the CMOS memory of the chipset. The microprocessor will check this every time you turn your system on and compare this to what it finds as it checks the system. This record is required for the system to operate.

3.12 Exit Without Saving

Selecting this option and pressing <Enter> lets you exit the setup program without recording any new values or changing old ones.

PCI SVGA/LCD Setup

This chapter details the software configuration information. It shows you how to configure the card to match your application requirements. The AWARD System BIOS is covered in Chapter 4.

Sections include:

- Installation of SVGA drivers
 - for Window XP
- Connections for standard LCDs
- Further information

Chapter 4 PCI SVGA/LCD Setup

4.1 Introduction

The board has an onboard AMD Geode LX800 chipset for its PCI/SVGA controller. It supports TFT LCD displays and conventional analog CRT monitors with 64MB frame buffer shared with system memory. The VGA controller can drive CRT displays with resolutions up to 1600 x 1200 x 16 bpp at 100 Hz and up to 1024 x 768 x 32 bpp at 60 Hz for TFT LCD.

4.1.1 Display type

The board can be set in one of three configurations: on a CRT, on a flat panel display, or on dual simultaneous display. The system is initially set to dual display mode. If you want to enable the CRT display only or the flat panel display only, please set them up from the BIOS screen, or, contact the technical support center.

4.1.2 Dual Simultaneous Display

The board uses a AMD LX800 controller that is capable of providing multiple views and simultaneous display with mixed video and graphics on a flat panel and CRT. The Dual display can be set up by CMOS setting.

4.1.3 CMOS setting for panel type

The board system BIOS and custom drivers are located in a 512 KB, Flash ROM device. A single Flash chip holds the system BIOS, VGA BIOS and network Boot ROM image. The display can be configured via CMOS settings. This method minimized the number of chips and different type of LCD panels, please choose "panel type" from the "Advanced Chipset Features" menu in CMOS setting.

4.2 Connections to Two Standard LCDs

Connector Table of 12.1" TTL Sharp LQ121S1DG31 800 x 600 5/3.3V (18 Bit) for PCM-3353 AMD Geode LX.

4.2.1 AMD Geode LX

Table 4.1: Connections to Sharp LQ121S1DG31 / PCM-3353

Sharp LQ121S1DG31		PCM-3353	
DF9MA-41P-1V		DF-13 4OP-1.25V	
Pin	Function	Pin	Function
1	GND	3	GND
2	CK	35	DOTCLK
3	GND	4	GND
4	Hsync	38	HS
5	Vsync	36	VS
6	GND		
7	GND		
8	GND	8	GND
9	R0	27	D18
10	R1	28	D19
11	R2	29	D20
12	GND		
13	R3	30	D21
14	R4	31	D22
15	R5	32	D23
16	GND		
17	GND		
18	GND		
19	G0	19	D10
20	G1	20	D11
21	G2	21	D12
22	GND		
23	G3	22	D13
24	G4	23	D14
25	G5	24	D15
26	GND	33	GND

Table 4.1: Connections to Sharp LQ121SIDG31 / PCM-3353

27	GND		
28	GND	33	GND
29	B0	11	D2
30	B1	12	D3
31	B2	13	D4
32	GND	34	GND
33	B3	14	D5
34	B4	15	D6
35	B5	16	D7
36	GND	34	GND
37	ENAB	37	DE
38	NC		
39	VCC	5	+3.3 V
40	VCC	6	+3.3 V
41	NC		

* The polarity of both synchronous signals are negative.

4.3 Installation of the SVGA Driver

Complete the following steps to install the SVGA driver. Follow the procedures in the flow chart that apply to the operating system that you are using within your board.

Notes:

- 1. The windows illustrations in this chapter are intended as examples only. Please follow the listed steps, and pay attention to the instructions which appear on your screen.*
- 2. For convenience, the CD-ROM drive is designated as "D" throughout this chapter.*

4.3.1 Installation chipset AES driver

1. Open device manager, right click on entertainment then, click on properties

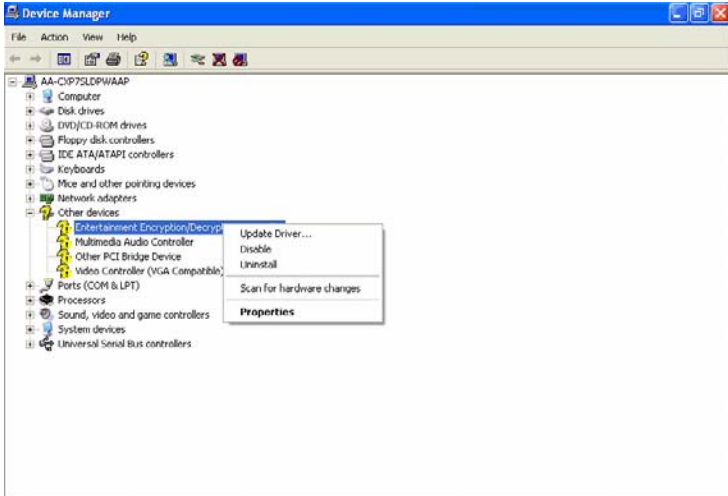

2. Go to driver page and click on update driver.

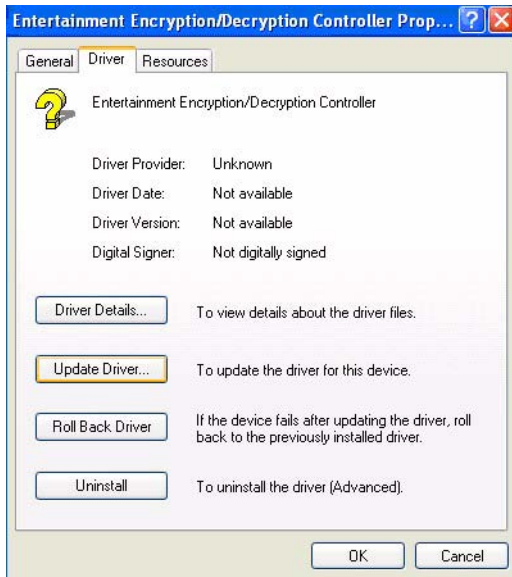

3. Click on install from specific folder and click on next.



4. Click on browse and select target folder, then, click OK.



5. Click on next.

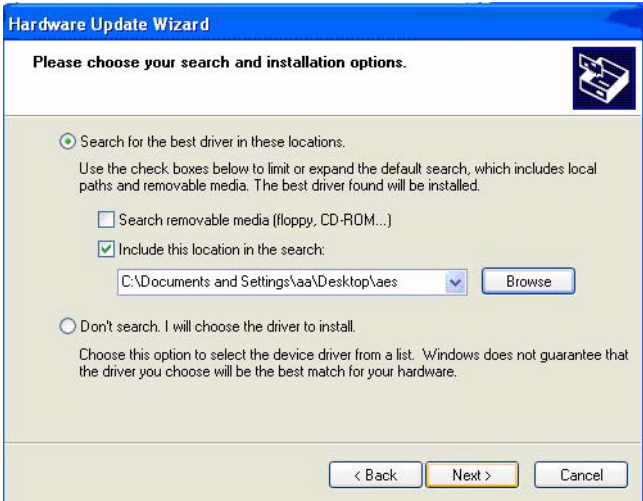

6. Click on finish.



4.3.2 Installation of VGA driver

1. Right click on video, and click “ Properties”.

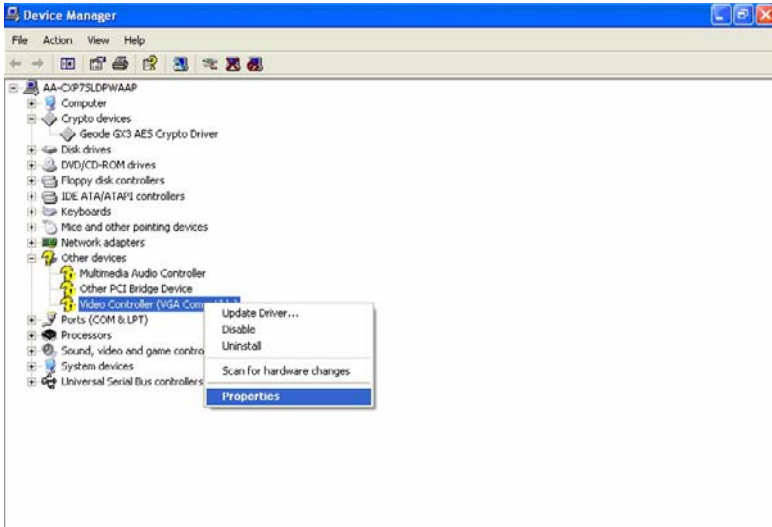

2. Go to driver page and click on update driver.

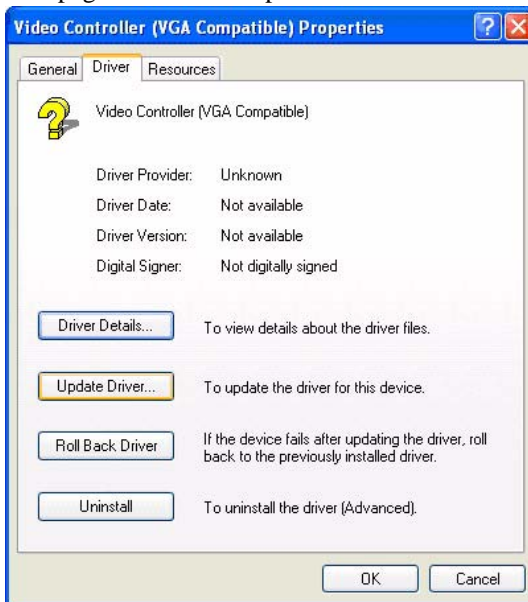

3. Click on install from specific folder and click on next.



4. Click on browse and select target folder, then click OK.



5. Click on next, then click on finish.

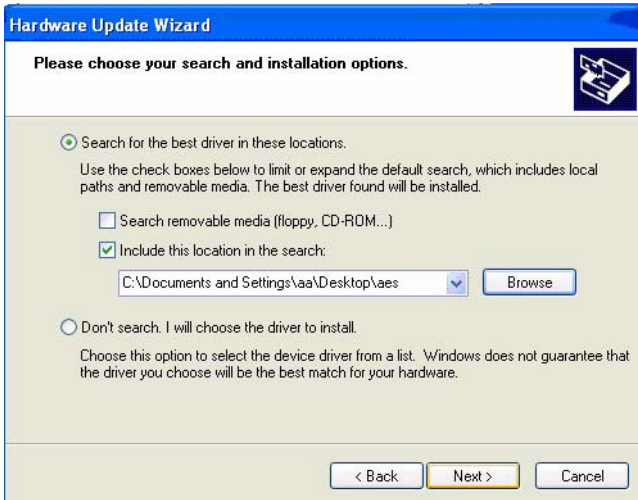

6. Then click on continue anyway.



7. Click on finish.



4.3.3 PCI Bridge

The system may detect PCI bridge automatically. If the question mark is shown on device manager, please install the driver as below:

1. Click “Add Hardware Wizard” and add new hardware wizard

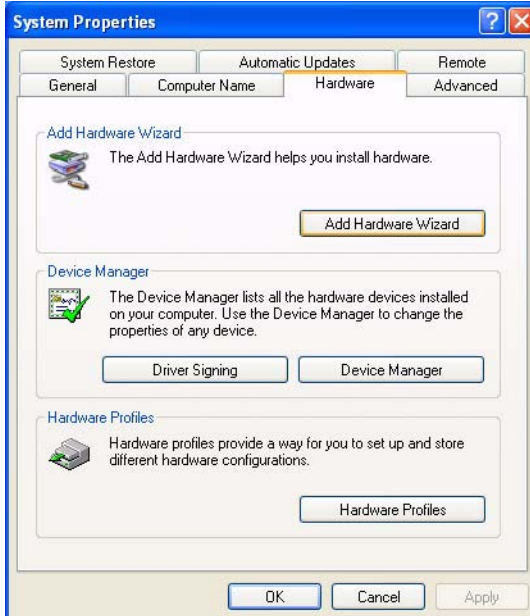



2. Search the right directory of PCI bridge for IT8888G driver.

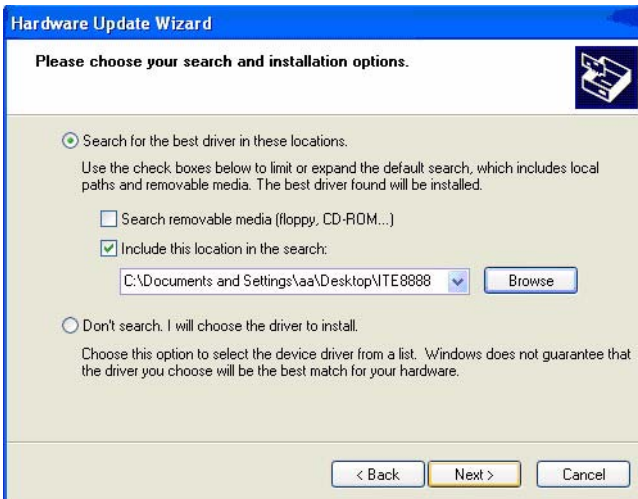

3. Installation finished.



4.4 Further Information

For further information about the AGP/VGA installation of your PCM-3353, including driver updates, troubleshooting guides and FAQ lists, visit the following web resources:

Intel website: www.intel.com

EMAC website: www.emacinc.com

Audio Setup

The board is equipped with an audio interface that records and plays back CD-quality audio. This chapter provides instructions for installing the software drivers included on the audio driver diskettes.

Chapter 5 Audio Setup

5.1 Introduction

The onboard audio interface provides high-quality stereo sound by using the AMD LX800 audio controller. The audio interface can record, compress, and play back voice, sound, and music with built-in mixer control.

5.2 Driver installation

5.2.1 Before you begin

Please read the instructions in this chapter carefully before you attempt installation. The audio drivers for the board are located on the audio driver CD. Run the supplied SETUP program to install the drivers; don't copy the files manually.

Note: *The files on the software installation diskette are compressed. Do not attempt to install the drivers by copying the files manually. You must use the supplied SETUP program to install the drivers.*

5.2.2 Windows XP drivers

1. Open device manager, right click on audio and click on “properties”.

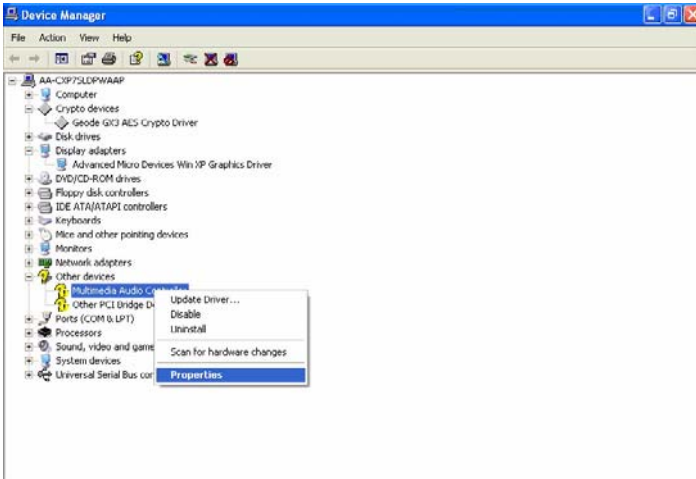

2. Go to driver page and click on update driver.

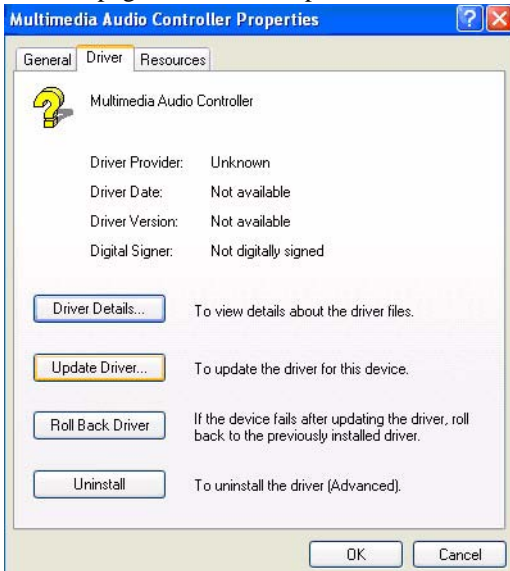

3. Click on install from specific folder and click on next.



4. Click on browse and select target folder, then click OK.



5. Click on next.

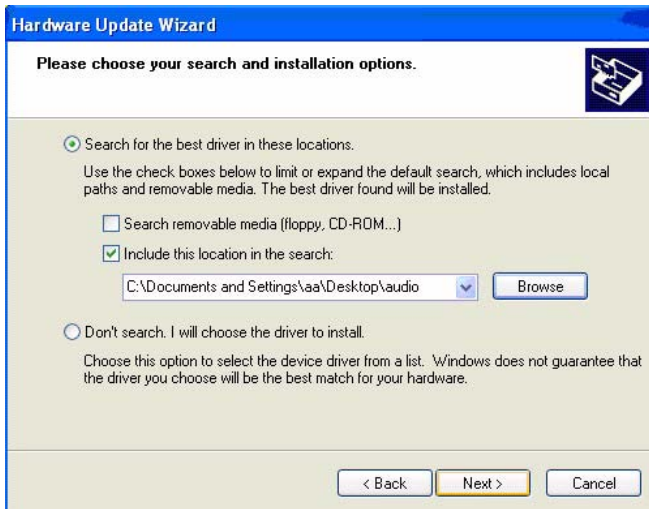

6. Click on continue anyway.



7. Click on finish.



Ethernet Interface

This chapter provides information on Ethernet configuration.

Sections include:

- Introduction
- Installation of Ethernet drivers for Windows XP
- Further information

Chapter 6 Ethernet Interface

6.1 Introduction

The board is equipped with a high performance 32-bit Ethernet chipset which is fully compliant with IEEE 802.3 100 Mbps CSMA/CD standards. It is supported by major network operating systems. With 100Base-T compatible. The network boot feature can be utilized by incorporating the boot ROM image files for the appropriate network operating system. The boot ROM BIOS files are combined with system BIOS, which can be enabled/disabled in the BIOS setup.

6.2 Installation of Ethernet driver

Before installing the Ethernet driver for Intel 82551ER chipset, note the procedures below. You must know which operating system you are using with your board, and then refer to the corresponding installation flow chart, just follow the steps described in the flow chart.

Note: *The windows illustrations in this chapter are examples only. Follow the steps and pay attention to the instructions which appear on your screen.*

6.2.1 Installation for Windows XP

1. a. Select "Start", "Settings", "Control Panel".
b. Double click "Network".

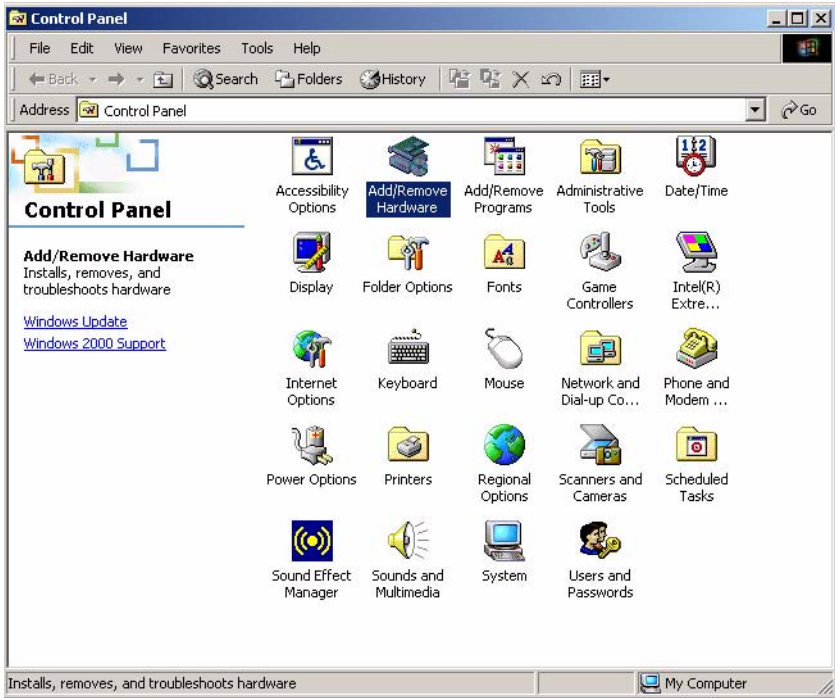

2. Click “Add new hardware wizard” and prepare to install network function



3. Choose Hardware Device “Ethernet Controller”

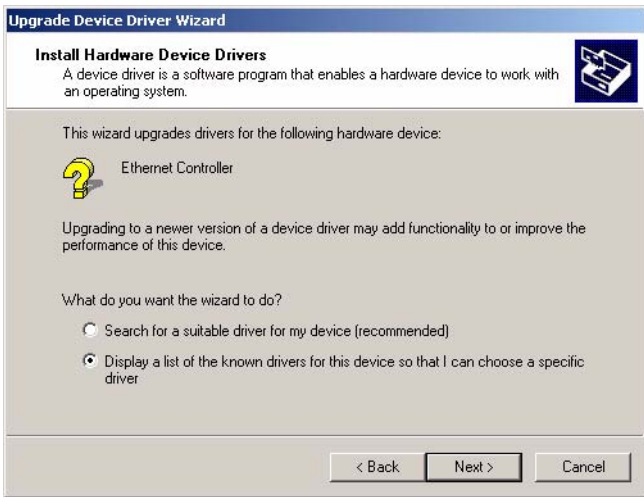
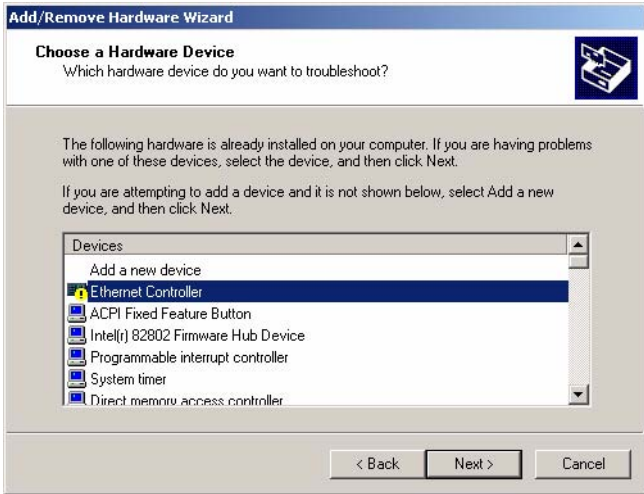

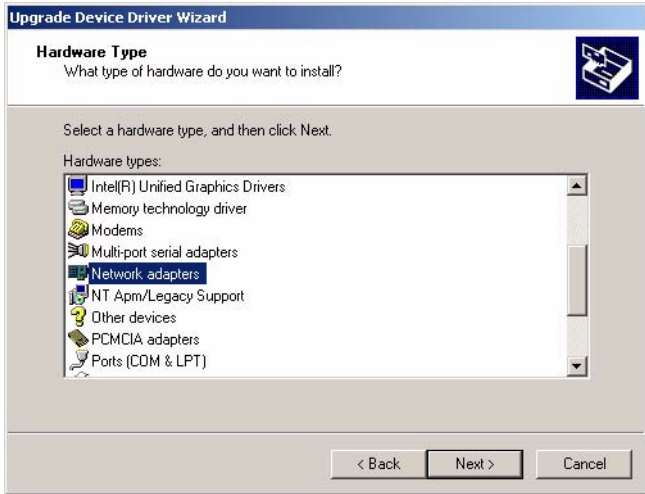

4. Insert the CD into D: drive
 - a. Fill in the Find the LAN chipset folder at the directory of PCM-3353 win2000 folder from CD ROM drive
 - b. Click “OK”.

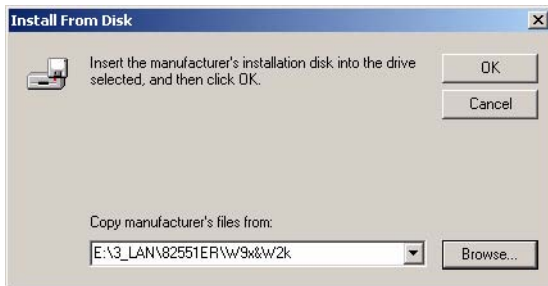

5. Choose the "Intel® GD82559ER PCI Adapter" item
Click "Next"

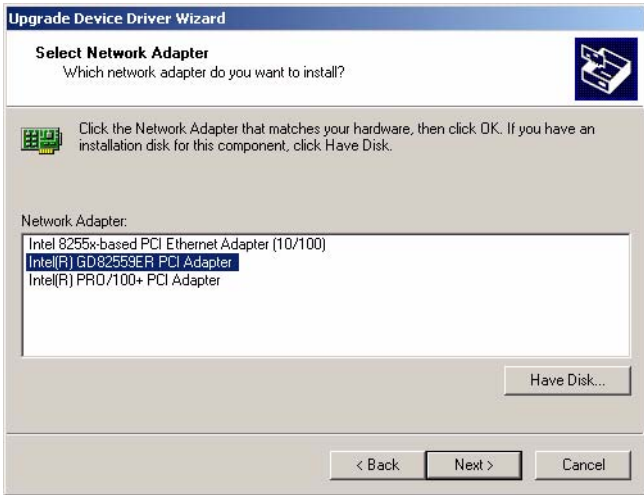

- 6 a. Make sure the configurations of relative items are set correctly
- b. Click “OK”



6.3 Further information

Intel website: www.intel.com
EMAC website: www.emacinc.com

Pin Assignments

This appendix contains information of a detailed or specialized nature. It includes:

Appendix A Pin Assignments

A.1 Jumper and Connector Tables

Table A.1: SW1, CF Master / Slave Selector

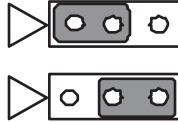

Part Number	1600000071
Footprint	JH2X1V-2M
Description	PIN HEADER 2*1P 180D (M)SQUARE 2.0mm
Setting	Function
(1 - 2)	Master (default)
(2 - 3)	Slave

Table A.2: J3, Clear CMOS

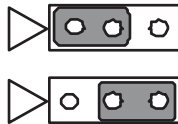

Part Number	1653003101
Footprint	JH3X1V-2M
Description	PIN HEADER 3*1P 180D (M)SQUARE 2.0mm
Setting	Function
(1 - 2)	BAT (default)
(2 - 3)	Clear-CMOS

Table A.3: CN39, COM2 Setting

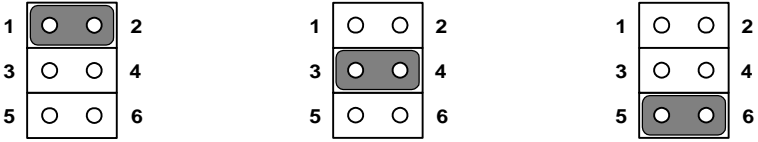

Part Number	1653003201
Footprint	JH3X2S-2M
Description	PIN HEADER 3*2P 180D SMDMALE SQUARE PIN 2.0mm
Setting	Function
(1 - 2)	RS232
(3 - 4)	RS485
(5 - 6)	RS422

**Table A.4: J5, PCI VI/
O POWER**

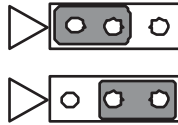

Part Number	1653003101
Footprint	JH3X1V-2M
Description	PIN HEADER 3*1P 180D (M)SQUARE 2.0mm
Setting	Function
(1 - 2)	With +5V
(2 - 3)	With +3.3V

Table A.5: CN42, LVDS LCD I/F

Part Number	1653910261		
Footprint	SPH10x2		
Description	*CONN. DF13-20DP-1.25V		
Pin	Pin Name	Signal Type	Signal Level
1	GND	GND	
2	GND	GND	
3	D0+	I/O	
4	NONE		
5	D0-	I/O	
6	NONE		
7	D1+	I/O	
8	NONE		
9	D1-	I/O	
10	NONE		
11	D2+	I/O	
12	NONE		
13	D2-	I/O	
14	NONE		
15	CLK+	I/O	
16	NONE		
17	CLK-	I/O	
18	NONE		
19	+5V/+3.3V	PWR	+5V/+3.3V
20	+5V/+3.3V	PWR	+5V/+3.3V

Table A.6: CN38, Power Input



Part Number	1655308020		
Footprint	PWR-B4PV		
Description	PIN HEADER DIP 8*1P 180D(M) 2.00mm		
Pin	Pin Name	Signal Type	Signal Level
1	+5V	PWR	+5V
2	+5V	PWR	+5V
3	+5V	PWR	+5V
4	GND	GND	-
5	GND	GND	-
6	GND	GND	-
7	GND	GND	-
8	+12V	PWR	+12V

Table A.7: CN4, TFT LCD I/F

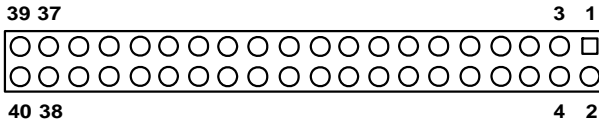

Part Number	1653920200		
Footprint	SPH20X2		
Description	*CONN. DF13-40DP-1.25V		
Pin	Pin Name	Signal Type	Signal Level
1	+5V	PWR	+5V
2	+5V	PWR	+5V
3	GND	GND	-
4	GND	GND	-
5	+3.3V	PWR	+3.3V
6	+3.3V	PWR	+3.3V
7	TV-CLK	CLK48M	+3.3V
8	GND	GND	-
9	D0	I/O	+3.3V
10	D1	I/O	+3.3V

11	D2	I/O	+3.3V
12	D3	I/O	+3.3V
13	D4	I/O	+3.3V
14	D5	I/O	+3.3V
15	D6	I/O	+3.3V
16	D7	I/O	+3.3V
17	D8	I/O	+3.3V
18	D9	I/O	+3.3V
19	D10	I/O	+3.3V
20	D11	I/O	+3.3V
21	D12	I/O	+3.3V
22	D13	I/O	+3.3V
23	D14	I/O	+3.3V
24	D15	I/O	+3.3V
25	D16	I/O	+3.3V
26	D17	I/O	+3.3V
27	D18	I/O	+3.3V
28	D19	I/O	+3.3V
29	D20	I/O	+3.3V
30	D21	I/O	+3.3V
31	D22	I/O	+3.3V
32	D23	I/O	+3.3V
33	GND	GND	-
34	GND	GND	-
35	DOTCLK	CLK	+3.3V
36	VS	OUT	+3.3V
37	DE	I/O	+3.3V
38	HS	OUT	+3.3V
39	RST	OUT	+3.3V
40	FP	OUT	+3.3V

Table A.8: CN5, Inverter Power

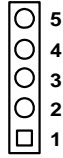

Part Number	1655305020		
Footprint	WHL5V-2M		
Description	WAFER BOX 2.0mm 5P 180D MALE W/LOCK		
Pin	Pin Name	Signal Type	Signal Level
1	+12V	PWR	+12V
2	GND	GND	-
3	ENABKL	OUT	+3.3V
4	VBR	OD	+3.3V
5	+5V	PWR	+5V

Table A.9: CN6, SMBus



Part Number	1653002101		
Footprint	JH2X1V-2M		
Description	PIN HEADER 2*1P 180D (M)SQUARE 2.0mm		
Pin	Pin Name	Signal Type	Signal Level
1	SMB-CLK	CLK	+3V
2	SMB-DAT	I/O	+3V

Table A.10: CN32, Reset / Buzzer pin header

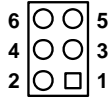

Part Number	1653002201		
Footprint	WHL2V-2M		
Description	PIN HEADER DIP 2*2P	180D(M)	2.00mm
Pin	Pin Name	Signal Type	Signal Level
1	-	-	-
2	-	-	-
3	GND	GND	-
4	RST	IN	+3.3V
5	Buzzer -	-	-
6	Buzzer +	-	-

Table A.11: CN36, GPIO1

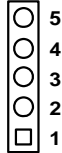

Part Number	1653010100		
Footprint	JH5X2S-2M		
Description	PIN HEADER SMD 5*1P	180D(M)	2.54mm
Pin	Pin Name	Signal Type	Signal Level
1	+5V	PWR	+5V
2	GPIO0	I/O	+5V
3	GPIO1	I/O	+5V
4	GPIO2	I/O	+5V
5	GPIO3	I/O	+5V

Table A.12: CN37, GPIO2

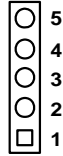

Part Number	1653010100		
Footprint	JH5X2S-2M		
Description	PIN HEADER SMD 5*1P 180D(M) 2.54mm		
Pin	Pin Name	Signal Type	Signal Level
1	GPIO4	I/O	+5V
2	GPIO5	I/O	+5V
3	GPIO6	I/O	+5V
4	GPIO7	I/O	+5V
5	GND	-	-

Table A.13: CN11, IDE

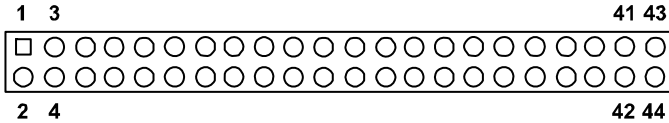

Part Number	1653222262		
Footprint	BH22X2SV		
Description	BOX HEADER SMD 22*2P 180D(M) 2.0mm IDIOT-PROOF		
Pin	Pin Name	Signal Type	Signal Level
1	RST#	Out	+5V
2	GND	GND	-
3	D7	I/O	+5V
4	D8	I/O	+5V
5	D6	I/O	+5V
6	D9	I/O	+5V
7	D5	I/O	+5V

8	D10	I/O	+5V
9	D4	I/O	+5V
10	D11	I/O	+5V
11	D3	I/O	+5V
12	D12	I/O	+5V
13	D2	I/O	+5V
14	D13	I/O	+5V
15	D1	I/O	+5V
16	D14	I/O	+5V
17	D0	I/O	+5V
18	D15	I/O	+5V
19	GND	GND	-
21	DREQ	Out	+5V
22	GND	GND	-
23	IOW#	Out	+5V
24	GND	GND	-
25	IOR#	Out	+5V
26	GND	GND	-
27	IRDY	Out	+5V
28	CSEL#	Out	+5V
29	DACK#	Out	+5V
30	GND	GND	-
31	IRQ14	In	+5V
32	NC	-	-
33	A1	In	+5V
34	D66DET#	In	+5V
35	A0	In	+5V
36	A2	In	+5V
37	CS#1	Out	+5V
38	CS#3	Out	+5V
39	ASP#	Out	+5V
40	GND	GND	-
41	+5V	PWR	+5V
42	+5V	PWR	+5V
43	GND	GND	-
44	NC	-	-

Table A.14: CN27, CRT

Part Number	1655912120		
Footprint	DBVGA-VF5M		
Description	CONN. 12P 90D(F) SMD 1.25mm		
Pin	Pin Name	Signal Type	Signal Level
1	GND	GND	-
2	R	OUT	Analog
3	G	OUT	Analog
4	B	OUT	Analog
5	GND	GND	-
6	+5V	PWR	-
7	DDAT	OD I/O	+3.3V
8	DCLK	OD I/O	+3.3V
9	GND	GND	-
10	HSYNC	OUT	+3.3V
11	VSYNC	OUT	+3.3V
12	GND	-	-

Table A.15: CN15, USB1/2

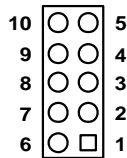

Part Number	1653005260		
Footprint	JH5X2S-2M		
Description	PIN HEADER 5*2P 180D(M) 2.0mm SMD IDIOT-PROOF		
Pin	Pin Name	Signal Type	Signal Level
1	+5V	PWR	+5V
2	+5V	PWR	+5V
3	P0-	I/O	USB

4	P1-	I/O	USB
5	P0+	I/O	USB
6	P1+	I/O	USB
7	GND	GND	-
8	GND	GND	-
9	GND	GND	-
10	NC	-	-

Table A.16: CN17, USB3/4

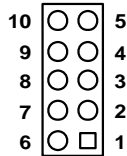

Part Number	1653005260		
Footprint	JH5X2S-2M		
Description	PIN HEADER 5*2P 180D(M) 2.0mm SMD IDIOT-PROOF		
Pin	Pin Name	Signal Type	Signal Level
1	+5V	PWR	+5V
2	+5V	PWR	+5V
3	P2-	I/O	USB
4	P3-	I/O	USB
5	P2+	I/O	USB
6	P3+	I/O	USB
7	GND	GND	-
8	GND	GND	-
9	GND	GND	-
10	NC	-	-

Table A.17: CN30, COM1/2/3/4

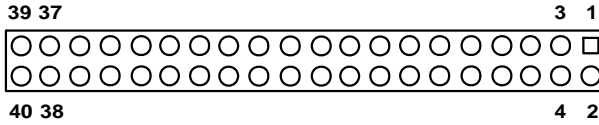

Part Number	1653220260		
Footprint	BH20X2SV- 2.00mm		
Description			
Pin	Pin Name	Signal Type	Signal Level
1	DCD#1	IN	-3~-12V, +3~+12V
2	DSR#1	IN	-3~-12V, +3~+12V
3	RXD1	IN	-3~-12V, +3~+12V
4	RTS#1	I/O	-3~-12V, +3~+12V
5	TXD1	OUT	-3~-12V, +3~+12V
6	CTS#1	IN	-3~-12V, +3~+12V
7	DTR#1	I/O	-3~-12V, +3~+12V
8	RI#1	IN	-3~-12V, +3~+12V
9	GND	GND	-
10	GND	GND	-
11	DCD#2	In	-3~-12V, +3~+12V
12	DSR#2	In	-3~-12V, +3~+12V
13	RXD2	In	-3~-12V, +3~+12V
14	RTS#2	I/O	-3~-12V, +3~+12V

15	TXD2	Out	-3~-12V, +3~+12V
16	CTS#2	In	-3~-12V, +3~+12V
17	DTR#2	I/O	-3~-12V, +3~+12V
18	RI#2	In	-3~-12V, +3~+12V
19	GND	GND	-
20	GND	GND	-
21	DCD#3	In	-3~-12V, +3~+12V
22	DSR#3	In	-3~-12V, +3~+12V
23	RXD3	In	-3~-12V, +3~+12V
24	RTS#3	I/O	-3~-12V, +3~+12V
25	TXD3	Out	-3~-12V, +3~+12V
26	CTS#3	In	-3~-12V, +3~+12V
27	DTR#3	I/O	-3~-12V, +3~+12V
28	RI#3	In	-3~-12V, +3~+12V
29	GND	GND	-
30	GND	GND	-
31	DCD#4	In	-3~-12V, +3~+12V
32	DSR#4	In	-3~-12V, +3~+12V
33	RXD4	In	-3~-12V, +3~+12V
34	RTS#4	I/O	-3~-12V, +3~+12V
35	TXD4	Out	-3~-12V, +3~+12V

36	CTS#4	In	-3~-12V, +3~+12V
37	DTR#4	I/O	-3~-12V, +3~+12V
38	RI#4	In	-3~-12V, +3~+12V
39	GND	GND	-
40	GND	-	-

Table A.18: CN19, Print Port

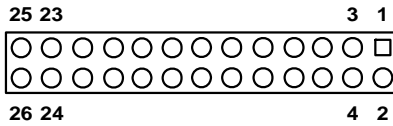

Part Number	1653213260		
Footprint	BH13x2SV-2.00		
Description	BOX HEADER SMD 13*2P 180D(M) 2.0mm		
Pin	Pin Name	Signal Type	Signal Level
1	STB#	Out	+5V
2	AFD#	Out	+5V
3	PD0	I/O	+5V
4	ERR#	In	+5V
5	PD1	I/O	+5V
6	INIT#	Out	+5V
7	PD2	I/O	+5V
8	SLIN#	Out	+5V
9	PD3	I/O	+5V
10	GND	GND	-
11	PD4	I/O	+5V
12	GND	GND	-
13	PD5	I/O	+5V
14	GND	GND	-
15	PD6	I/O	+5V
16	GND	GND	-
17	PD7	I/O	+5V

18	GND	GND	-
19	ACK#	In	+5V
20	GND	GND	-
21	BUSY	In	+5V
22	GND	GND	-
23	PE	In	+5V
24	GND	GND	-
25	SLCT	In	+5V
26	NC	-	-

Table A.19: CN20, RS422/485

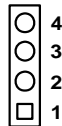

Part Number	1653004101		
Footprint	JH4X1V-2M		
Description	PIN HEADER 4*1P 180D(M) SQUARE 2.0mm		
Pin	Pin Name	Signal Type	Signal Level
1	422-RXD-	In	+5V
2	422-RXD+	In	+5V
3	485-422-TXD+	Out	+5V
4	485-422-TXD-	Out	+5V

Table A.20: CN35, AUDIO-OUT

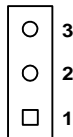

Part Number	1655303120		
Footprint	WHL3V-2M		
Description	WAFER BOX 2.0mm 3P 180D w/LOCK		

Pin	Pin Name	Signal Type	Signal Level
1	LIN-OUT-R	OUT	Analog
2	GND	GND	-
3	LIN-OUT-L	Out	Analog

Table A.21: CN34, AUDIO-IN

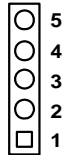

Part Number	16553050202		
Footprint	WHL3V-2M		
Description	WAFER BOX 2.0mm 3P 180D w/LOCK		
Pin	Pin Name	Signal Type	Signal Level
1	LIN-IN-R	IN	Analog
2	GND	GND	-
3	LIN-IN-L	IN	Analog
4	GND	GND	-
5	MIC-IN	IN	Analog

Table A.22: CN23, ISA -5V & -12V Input

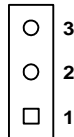

Part Number	1653003101		
Footprint	JH3X1V-2M		

Description	PIN HEADER 3*1P 180D (M)SQUARE 2.0mm		
Pin	Pin Name	Signal Type	Signal Level
1	-12V	PWR	-12V
2	-5V	PWR	-5V
3	GND	GND	-

Table A.23: CN26, LAN1

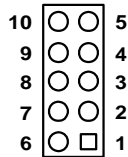

Part Number	1653205260		
Footprint	BH5X2SV		
Description	BOX HEADER SMD 5*2 180D (M) 2.0mm		
Pin	Pin Name	Signal Type	Signal Level
1	+3.3V	PWR	+3.3V
2	LAN2-ACTLED	IN	Analog
3	LAN2-RX+	IN	Analog
4	LAN2-RX-	IN	Analog
5	LAN2-LILED	IN	Analog
6	LAN2-LCT	I/O	Analog
7	N/A	-	-
8	LAN2-LCT	I/O	Analog
9	LAN2-TX+	OUT	Analog
10	LAN2-TX-	OUT	Analog

Table A.24: CN18, KB/MS



Part Number	1655306020		
Footprint	BH5X2SV		
Description	BOX HEADER DIP 6*1 180D (M) 2.0mm		
Pin	Pin Name	Signal Type	Signal Level
1	KB-CLK	IN	+5V
2	KB-DATA	IN	+5V
3	MS-CLK	IN	+5V
4	GND	PWR	-
5	+5V	PWR	+5V
6	MS-DATA	IN	+5V

Table A.25: CN40, DDR RAM SOCKET

Part Number	1651000051
Footprint	
Description	SODIMM 200P DDR SMD

Table A.26: CN41, CF SOCKET

Part Number	1653025211
Footprint	JH5X2S-2M
Description	HEADER 50P 90D

System Assignments

This appendix contains information of a detailed nature. It includes:

- System I/O ports
- 1st MB memory map
- DMA channel assignments
- Interrupt assignments

Appendix B System Assignments

B.1 System I/O Ports

Table B.1: System I/O ports

Addr. range (Hex)	Device
000-01F	DMA controller
020-021	Interrupt controller 1, master
040-05F	8254 timer
060-06F	8042 (keyboard controller)
070-07F	Real-time clock, non-maskable interrupt (NMI) mask
080-09F	DMA page register
0A0-0BF	Interrupt controller 2
0C0-0DF	DMA controller
0F0	Clear math co-processor
0F1	Reset math co-processor
0F8-0FF	Math co-processor
1F0-1F8	Fixed disk
200-207	Reserved (Game I/O)
278-27F	Reserved (Parallel port 2,LTP3)
2E8-2EF	Reserved (Series port 4)
2F8-2FF	Serial port 2
300-31F	Prototype card
360-36F	Reserved
378-37F	Parallel printer port 1 (LPT 2)
380-38F	SDLC, bisynchronous 2
3A0-3AF	Bisynchronous 1
3B0-3BF	Monochrome display and printer adapter (LPT1)
3C0-3CF	Reserved
3D0-3DF	Color/graphics monitor adapter
3E8-3EF	Reserved (Series port 3)
3F0-3F7	Diskette controller
3F8-3FF	Serial port 1

* PNP audio I/O map range from 220 ~ 250H (16 bytes)

MPU-401 select from 300 ~ 330H (2 bytes)

B.2 1st MB memory map

Table B.2: 1st MB memory map

Addr. range (Hex)	Device
F0000h - FFFFFh	System ROM
*CC000h - EFFFFh	Unused (reserved for Ethernet ROM)
C0000h - CBFFFh	Expansion ROM (for VGA BIOS)
B8000h - BFFFFh	CGA/EGA/VGA text
B0000h - B7FFFh	Unused
A0000h - AFFFFh	EGA/VGA graphics
00000h - 9FFFFh	Base memory

* If Ethernet boot ROM is disabled (Ethernet ROM occupies about 16 KB)

* E0000 - EFFFF is reserved for BIOS POST

B.3 DMA channel assignments

Table B.3: DMA channel assignments

Channel	Function
0	Available
1	Available (audio)
2	Floppy disk (8-bit transfer)
3	Available (parallel port)
4	Cascade for DMA controller 1
5	Available
6	Available
7	Available

* Audio DMA select 1, 3, or 5

** Parallel port DMA select 1 (LPT2) or 3 (LPT1)

B.4 Interrupt assignments

Table B.4: Interrupt assignments

Interrupt#	Interrupt source
IRQ 0	Interval timer
IRQ 1	Keyboard
IRQ 2	Interrupt from controller 2 (cascade)
IRQ 3	COM2
IRQ 4	COM1
IRQ 5	Reserved (COM4)
IRQ 6	FDD
IRQ 7	LPT1
IRQ 8	RTC
IRQ 9	Reserved (audio)
IRQ 10	Reserved (COM3)
IRQ 11	Reserved for watchdog timer
IRQ 12	PS/2 mouse
IRQ 13	INT from co-processor
IRQ 14	Primary IDE
IRQ 15	Secondary IDE for CFC

* Ethernet interface IRQ select: 9, 11, 15

* PNP audio IRQ select: 9, 11, 15

* PNP USB IRQ select: 9, 11, 15

* PNP ACPI IRQ select: 9, 11, 15

Appendix

C

Mechanical Drawings

