

AFP-6123

Intel® Atom™ D2550 Processor
Full IP66 Stainless Panel PC
12.1" TFT LCD with 7H Surface

Copyright Notice

This document is copyrighted, 2013. All rights are reserved. The original manufacturer reserves the right to make improvements to the products described in this manual at any time without notice.

No part of this manual may be reproduced, copied, translated, or transmitted in any form or by any means without the prior written permission of the original manufacturer. Information provided in this manual is intended to be accurate and reliable. However, the original manufacturer assumes no responsibility for its use, or for any infringements upon the rights of third parties that may result from its use.

The material in this document is for product information only and is subject to change without notice. While reasonable efforts have been made in the preparation of this document to assure its accuracy, AAEON assumes no liabilities resulting from errors or omissions in this document, or from the use of the information contained herein.

AAEON reserves the right to make changes in the product design without notice to its users.

Acknowledgments

All other products' name or trademarks are properties of their respective owners.

- Award is a trademark of Award Software International, Inc.
- Intel[®], and Atom[™] are trademarks of Intel[®] Corporation.
- Microsoft Windows[®] is a registered trademark of Microsoft Corp.
- IBM, PC/AT, PS/2, and VGA are trademarks of International Business Machines Corporation.

All other product names or trademarks are properties of their respective owners.

Packing List

Before you begin operating your PC, please make sure that the following materials are enclosed:

- 1 USB Cable with 2 USB Waterproof Connectors
- 2 COM Cables with water proof Connectors
- 1 waterproof Connector for DC-in (Female)
- 1 waterproof Connector for LAN (optional)
- 1 CD-ROM for manual (in PDF format)
- 1 AFP-6123 Full IP66 Stainless Panel PC

If any of these items should be missing or damaged, please contact your distributor or sales representative immediately.

Optional Accessories

- **1757910004**
AC Adapter (100W)
- **1702031802**
AC Adapter Cord (US Type)
- **1702031803**
AC Adapter Cord (European Type)
- **170203180E**
AC Adapter Cord (Japanese Type)
- **9761215304**
Water-proof Wireless Module (b/g/n)
- **9761215301**
USB GPS Kit
- **9761215302**
3G & GPS Kit

Safety & Warranty

1. Read these safety instructions carefully.
2. Keep this user's manual for later reference.
3. Disconnect this equipment from any DC outlet before cleaning. Do not use liquid or spray detergents for cleaning. Use a damp cloth.
4. For pluggable equipment, the power outlet must be installed near the equipment and must be easily accessible.
5. Keep this equipment away from humidity.
6. Put this equipment on a firm surface during installation. Dropping it or letting it fall could cause damage.
7. The openings on the enclosure are for air convection. Protect the equipment from overheating. **DO NOT COVER THE OPENINGS.**
8. Make sure the voltage of the power source is correct before connecting the equipment to the power outlet.
9. Position the power cord so that people cannot step on it. Do not place anything over the power cord.
10. All cautions and warnings on the equipment should be noted.
11. If the equipment is not used for a long time, disconnect it from the power source to avoid damage by transient over-voltage.
12. Never pour any liquid into an opening. This could cause fire or electrical shock.
13. Never open the equipment. For safety reasons, only qualified service personnel should open the equipment.
14. If any of the following situations arises, get the equipment checked by service personnel:
 - a. The power cord or plug is damaged.
 - b. Liquid has penetrated into the equipment.

- c. The equipment has been exposed to moisture.
 - d. The equipment does not work well, or you cannot get it to work according to the user's manual.
 - e. The equipment has been dropped and damaged.
 - f. The equipment has obvious signs of breakage.
15. DO NOT LEAVE THIS EQUIPMENT IN AN ENVIRONMENT WHERE THE STORAGE TEMPERATURE IS BELOW -20°C (-4°F) OR ABOVE 70°C (140°F). IT MAY DAMAGE THE EQUIPMENT.
16. DO NOT OPEN the sealed Enclosure /case of equipment. Once enclosure is disassembled without approval, it will lead in abnormal operating of water proof gel. For Guarantee of water proof function, please make sure configuration/ peripheral (HDD,RAM, peripherals) has been confirmed to install before shipping.

FCC

Warning!



This device complies with Part 15 FCC Rules. Operation is subject to the following two conditions: (1) this device may not cause harmful interference, and (2) this device must accept any interference received including interference that may cause undesired operation.

Caution:

There is a danger of explosion if the battery is incorrectly replaced. Replace only with the same or equivalent type recommended by the manufacturer. Dispose of used batteries according to the manufacturer's instructions and your local government's recycling or disposal directives.

Below Table for China RoHS Requirements

产品中有毒有害物质或元素名称及含量

AAEON Panel PC/ Workstation

部件名称	有毒有害物质或元素					
	铅 (Pb)	汞 (Hg)	镉 (Cd)	六价铬 (Cr(VI))	多溴联苯 (PBB)	多溴二苯醚 (PBDE)
印刷电路板 及其电子组件	×	○	○	○	○	○
外部信号 连接器及线材	×	○	○	○	○	○
外壳	×	○	○	○	○	○
中央处理器 与内存	×	○	○	○	○	○
硬盘	×	○	○	○	○	○
液晶模块	×	○	○	○	○	○
光驱	×	○	○	○	○	○
触控模块	×	○	○	○	○	○
电源	×	○	○	○	○	○

O: 表示该有毒有害物质在该部件所有均质材料中的含量均在
SJ/T 11363-2006 标准规定的限量要求以下。

X: 表示该有毒有害物质至少在该部件的某一均质材料中的含量超出
SJ/T 11363-2006 标准规定的限量要求。

备注:

- 一、此产品所标示之环保使用期限，系指在一般正常使用状况下。
- 二、上述部件物质中央处理器、内存、硬盘、光驱、触控模块为选购品。

Contents

Chapter 1 General Information

1.1 Introduction.....	1-2
1.2 Features	1-3
1.3 Specification	1-4
1.4 Dimension	1-7

Chapter 2 Hardware Installation

2.1 USB 1/2 Connector	2-2
2.2 COM 1 Connector for RS232	2-2
2.3 COM 2 Connector for RS232/RS422/RS485.....	2-3
2.4 DC-IN 9~30V Connector	2-4

Chapter 3 AMI BIOS set up

3.1 System Test and Initialization	3-2
3.2 AMI BIOS Setup	3-3

Chapter 4 Driver Installation

4.1 Installation	4-3
------------------------	-----

Appendix FAQ

A.1 FAQ.....	A-2
--------------	-----

Chapter

1

**General
Information**

1.1 Introduction

AFP-6123 Full IP66 Stainless Panel PC is a high-performance computing and completely fan-less solution for applications in the Food industry, because AFP-6123 has the full IP-66 protection, 316L stainless and 7H Hardness surface. AFP-6123 comes with Intel® Atom™ D2550 processor, 12.1" TFT LCD Display with LED Backlight 316L Stainless, 7H hardness surface, Sealing enclosure (IP66 certificated) and Water proof I/O connectors for Ethernet , multi-COM port, audio and USB interfaces.

Besides, for system integrators, a simple, complete, compact and highly integrated system helps you smoothly build an industrial grade solution into your applications. By this concept, AFP-6123 is design with valuable features (listed in next section) to serve various field of markets such as Factory and Outdoor, especially Food industry.

1.2 Features

- 12.1" 1024 x 768 TFT LCD with LED Backlight, 400 nits
- Glass-Film-Glass touch with 7H hardness surface
- IP66 Protection Certificated
- Supports Windows 7, Linux Kernal 2.6X and above
- Wide Operating Temperature Range: -20°C~50°C (With HDD)
- Mini PCIe x 1
- Waterproof Lockable I/O: Standard M12 Waterproof Connector

1.3 Specification

System

- CPU Onboard Intel® Atom™ D2550 1.86 GHz Processor
- System Memory DDR3 SODIMM, Max. 4GB
- Motherboard GENE-CV05
- M12 water proof I/O Port RS-232 x 2
USB Cable with 2 USB connectors x 1
Power Input
10/100/1000Base-TX RJ-45
- Storage Disk Drive Internal Type II Compact Flash™/
Internal Anti-vibration 2.5" Hard Disk
- OS Support Windows® 7 (32bits), Windows® XP,
Linux Kernel 2.6X and above

Mechanical

- Construction 316L Stainless
- Mounting VESA 75/100mm holes
- Dimension 14.6" (W) x 11.2" (H) x 3.42" (D)
(370mm x 285mm x 87mm)
- Net Weight 15.25 lb (6.93 Kg)
- Gross Weight 18.04 lb (8.2 Kg)

Environmental

- Operating Temperature -4°F~122°F (-20°C~50°C);
With W/T Hard Disk drive
- Storage Temperature -4°F~158°F(-20°C~70°C)
- Operating Humidity 5% to 90%@40°C, non-condensing
- Vibration Random Operation 1G, 5-500Hz
- Shock 15 G peak acceleration (11 msec.
duration)
- EMC CE/FCC Class A
- Power Supply Input: DC 9~30V

LCD

- Display Type 12.1" Color TFT LCD
- Max. Resolution 1024 x 768
- Max. Colors 16.2M colors
- Luminance 500 nits
- Viewing Angle 160° (H) x 140° (V)

Touch Screen

- Type 5-Wire Glass-Film-Glass touch with 7H
hardness surface
- Lifetime 10 million activations

Note 1: All AAEON's LCD products are manufactured with High precision technology. However, in all LCD panels there maybe a small number of defective pixels that do not change color. This is a normal

occurrence for all LCD displays from all manufacturers and should not be noticeable or objectionable under normal operation. AAEON qualify the LCD panel following industry standard: total 7 dead pixels on a screen or if there are 3 within 1 inch square area of each other on the display.

Note 2:

For keeping the original waterproof design of the product, it is highly recommended to tell us HDD or CFast™ you may need when you place an order to AAEON. We AAEON will install a HDD or CFast™ for you before shipping.

1.4 Dimension

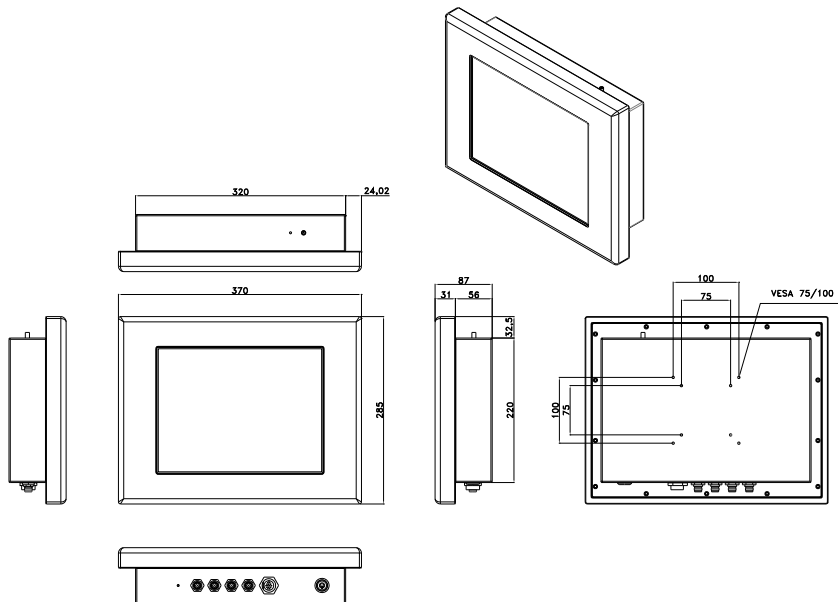

Unit: mm

VESA 75/100 mount holes



Connectors



Chapter

2

**Hardware
Installation**

2.1 USB 1/2 Connector

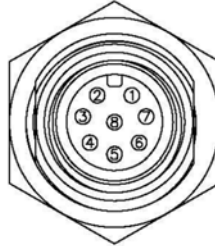

Pin Assignments
Front View

Pin	Signal	Pin	Signal
1	USB1 V+	2	USB0 V+
3	USB D0+	4	USB D0-
5	USB0 GND	6	USB D1+
7	USB D1-	8	USB1 GND

2.2 COM1 Connector for RS-232

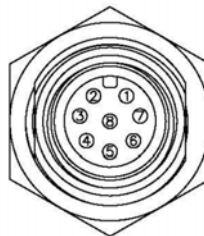

Pin Assignments
Front View

Pin	Signal	Pin	Signal
1	DCD	2	RXD
3	TXD	4	DTR
5	GND	6	DSR
7	RTS	8	CTS

2.3 COM2 Connector for RS-232/422/485

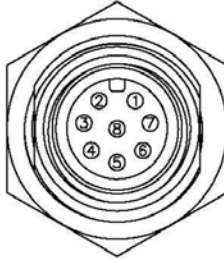

Pin Assignments
Front View

RS-232

Pin	Signal	Pin	Signal
1	DCD	2	RXD
3	TXD	4	DTR
5	GND	6	DSR
7	RTS	8	CTS

RS-422

Pin	Signal	Pin	Signal
1	TXD-	2	RXD+
3	TXD+	4	RXD-

RS-485

Pin	Signal	Pin	Signal
1	TXD-	2	NC
3	TXD+	4	NC

2.4 DC-IN 9~30V Connector

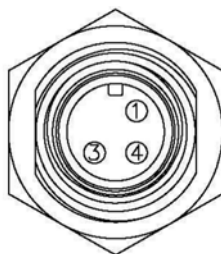

Pin Assignments
Front View

Pin	Signal	Pin	Signal
1	DC V+	2	N/A
3	GND	4	NC

Chapter

3

**AMI
BIOS Setup**

3.1 System Test and Initialization

These routines test and initialize board hardware. If the routines encounter an error during the tests, you will either hear a few short beeps or see an error message on the screen. There are two kinds of errors: fatal and non-fatal. The system can usually continue the boot up sequence with non-fatal errors.

System configuration verification

These routines check the current system configuration against the values stored in the CMOS memory. If they do not match, the program outputs an error message. You will then need to run the BIOS setup program to set the configuration information in memory.

There are three situations in which you will need to change the CMOS settings:

1. You are starting your system for the first time
2. You have changed the hardware attached to your system
3. The CMOS memory has lost power and the configuration information has been erased.

The AFP-6123 CMOS memory has an integral lithium battery backup for data retention. However, you will need to replace the complete unit when it finally runs down.

3.2 AMI BIOS Setup

AMI BIOS ROM has a built-in Setup program that allows users to modify the basic system configuration. This type of information is stored in battery-backed CMOS RAM so that it retains the Setup information when the power is turned off.

Entering Setup

Power on the computer and press or <F2> immediately. This will allow you to enter Setup.

Main

Set the date, use tab to switch between date elements.

Advanced

Advanced BIOS Features Setup including TPM, ACPI, etc.

Chipset

Host bridge parameters.

Boot

Enables/disable quiet boot option.

Security

Set setup administrator password.

Save&Exit

Exit system setup after saving the changes.

Chapter

4

**Driver
Installation**

The AFP-6123 comes with a CD-ROM that contains all drivers and utilities that meet your needs.

Follow the sequence below to install the drivers:

Step 1 – Install Chipset Driver

Step 2 – Install VGA Driver

Step 3 – Install LAN Driver

Step 4 – Install AHCI Driver (based on customer's application needs)

Step 5 – Install Touch Driver

Step 6 – Install Wireless LAN & Bluetooth Driver (Optional)

Step 7 – Install GPS Driver (Optional) (for test only)

Step 8 – Install GSM Driver (Optional) (for test only)

4.1 Installation:

Insert the AFP-6123 CD-ROM into the CD-ROM Drive. And install the drivers from Step 1 to Step 6 in order. Step 7 and Step 8 are for testing purpose.

Step 1 – Install Chipset Driver

1. Click on the **STEP1-CHIPSET** folder and double click on the **Setup.exe** file
2. Follow the instructions that the window shows
3. The system will help you install the driver automatically

Step 2 – Install VGA Driver

For Windows® 7

1. Click on the **STEP2-VGA** folder and select the folder of **WIN7_32**
2. Double click on the **Setup.exe** file
3. Follow the instructions that the window shows
4. The system will help you install the driver automatically

For Windows® XP

1. Install Framework 3.5
 - Double click on the **dotnetfx35.exe**
 - Follow the instructions that the window shows
 - The system will help you install the driver automatically
2. Install IEMGD
 - Double click on the **WindowsDriverSETUP.exe**

- Select the configuration
- Follow the instructions that the window shows
- The system will help you install the driver automatically

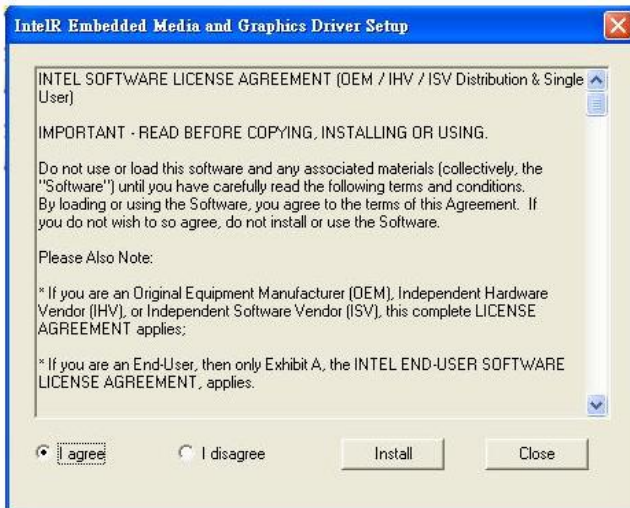



If you want to update driver, please uninstall driver first.

Uninstall IEMGD

1. Double click on the **WindowsDriverSETUP.exe**
2. Follow the instructions that the window shows
3. The system will help you uninstall the driver automatically



Step 3 – Install LAN Driver

1. Click on the **STEP3-LAN** folder and double click on the **setup.exe** file
2. Follow the instructions that the window shows
3. The system will help you install the driver automatically

Step 4 – Install AHCI Driver (based on customer's application needs to install the AHCI driver)

1. Click on the **STEP4-AHCI** folder and double click on the **setup.exe** file
2. Follow the instructions that the window shows
3. The system will help you install the driver automatically

Step 5 – Install Touch Driver

1. Click on the **STEP5-TOUCH** folder and double click on the **Setup.exe** file
2. Follow the instructions that the window shows
3. The system will help you install the driver automatically

Step 6 – Install Wireless LAN & Bluetooth Driver (Optional)

1. Click on the **STEP6-WIRELESS LAN&BT (option)** folder and select the folder based on the driver you are going to install
2. Double click on the **.exe** file located in **WLAN or BT** folders
3. Follow the instructions that the window shows
4. The system will help you install the driver automatically

Step 7 – Install GPS Driver (Optional)

It is a test tool and for test only.

Step 8 – Install GSM Driver (Optional)

It is a test tool and for test only.

Appendix

A

FAQ

A.1 FAQ

1. What does the Day/Night Mode button actually do?

Answer:

Day mode is the highest brightness for out door use, Night mode is lowest one for power saving and navigation safty.

2. What type of anti-glare treatment are you putting onto your touch screen and what is the LCD brightness reduction with this treatment?

Answer:

We use Low Reflection touch screen with Anti-Refelctive surface which incorporates "circular polarizer" filems inside.It is new technology of Touch panel , which has several layers of films, applied to reduce the amount of reflection back into the users eye (Reflectivity: $1.5 \pm 1\%$)and increase "contrast ratio" of display in outdoor environment.

3. How to use M12 LAN Connector?

Step 1: Peel off the release paper of gasket of RJ-45 plug cable set and stick it to its body.



Step 2: Cut off the present RJ-45 plug.



Step 3: Put all parts of RJ45 plug cable set through cable in order.



Step 4: Install and crimp a new RJ-45 plug.

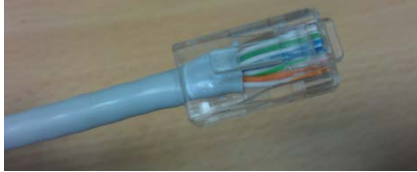

Step 5: Insert RJ-45 plug into the socket and mount cable set's body. Make sure RJ-45's latch is in place.



Step 6: Lock and tighten the nut of RJ-45 plug.



Step 7: Screw on the plastic rear nut a little bit for later locking. Make sure sealer is in place.

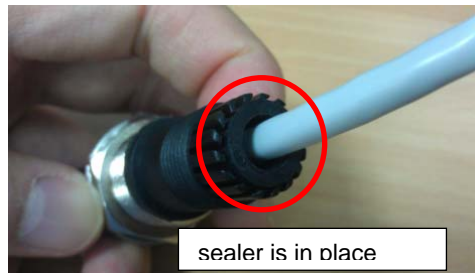

Step 8: Press the cable hard inward and lock the plastic rear nut tightly at the same time.



Step 9: Tighten the plastic rear nut more to make sure the cable is secured from being moved by any unexpected force.

