

Our Products Make Your Product Better®

To learn more about EMAC's products and services and how they can help your project

http://ftp.emacinc.com/Tech_Info/About_EMAC_Products_and_Services.pdf



Authorized Distributor, Integrator, and Value-Added Reseller

Manual downloaded from ftp.emacinc.com

For purchase information please contact info@emacinc.com

For technical support please submit a ticket at www.emacinc.com/support



MODEL:

AFL4-W10/W12/12/W13-EHL

Panel PC equips Intel® Celeron® J6412 on-board processor, 8GB LPDDR4X on-board, IEEE 802.11 a/b/g/n/ax, Bluetooth V5.2, one M.2 2242 M key Slot, one M.2 2242 M key Slot

User Manual

Rev. 1.00 - May 29, 2023



Revision

| Date | Version | Changes |
|--------------|---------|-----------------|
| May 29, 2023 | 1.00 | Initial release |



Safety Instructions

- en** Warning! Read the user manual before connecting the system to the power source.
- de** Vorsicht! Bitte lesen Sie die Bedienungsanleitung, bevor Sie das System an eine Stromquelle anschließen.
- fr** Attention! Avant de brancher le système à la source d'alimentation, consultez le mode d'emploi.
- it** Avvertenza! Consultare il manuale utente prima di collegare il sistema all'alimentatore.
- es** Atención! Lea atentamente este manual del usuario antes de operar la fuente de alimentación.
- zh** 警告! 在將系統連接到電源之前, 請仔細閱讀使用手冊。
- cn** 警告! 在將系統連接到電源之前, 請仔細閱讀使用手冊。
-

- en** Warning! To prevent the system from overheating, do not operate it in an area that exceeds the maximum operating temperature described in the user manual.
- de** Vorsicht! Um eine Überhitzung des Systems zu vermeiden, betreiben Sie es ausschließlich im zulässigen Betriebstemperaturbereich. Dieser ist in der Bedienungsanleitung vermerkt.
- fr** Attention! Pour éviter la surchauffe du système, ne l'utilisez pas dans une zone dont la température dépasse les limites décrits dans le mode d'emploi.
- it** Avvertenza! Per evitare che il sistema si surriscaldi, non utilizzarlo in aree che superino la temperatura massima d'esercizio descritta nel manuale utente.
- es** Atención! Para evitar el excesivo calentamiento del sistema, no opere en las condiciones de temperatura superior a lo recomendado en este manual del usuario.
- zh** 警告! 為防止系統過熱, 不要在超過使用手冊上記載的產品工作溫度範圍之外操作此系統。
- cn** 警告! 為防止系統過熱, 不要在超過使用手冊上記載的產品工作溫度範圍之外操作此系統。
-

- en** Warning! Use only the adapter and power cord approved for this system. Use of another type of adapter may risk fire or explosion. Please refer to the user manual for the power adapter specifications.
- de** Vorsicht! Nur zugelassene Netzteile und Netzkabel dürfen verwendet werden. Die Benutzung von anderen Netzteilen kann einen Brand oder eine Explosion zur Folge haben. Prüfen Sie die jeweiligen Spezifikationen in der Bedienungsanleitung.
- fr** Attention! Utilisez exclusivement le câble d'alimentation et l'adaptateur homologués pour ce système. L'utilisation d'un autre type d'adaptateur risquerait de provoquer un incendie ou une explosion. Veuillez référer au mode d'emploi pour les spécifications de l'adaptateur d'alimentation.
- it** Avvertenza! Utilizzare solo l'adattatore e il cavo di alimentazione approvati per questo sistema. L'uso di un altro tipo di adattatore può causare rischio d'incendio o esplosione. Si prega di fare riferimento al manuale utente per le specifiche sull'alimentazione.
- es** Atención! Utilice solamente el adaptador de corriente alterna (CA) con Marcas Conformidad otorgadas. Cualquier otro adaptador no otorgado aumenta el riesgo de explosión o incendio. Por favor consulte el manual del usuario para las especificaciones del adaptador de alimentación.
- zh** 警告! 只能使用經過認證、適用於本系統的電源變壓器與電源線。使用不適用的電源變壓器將可能導致火災或爆炸。電源變壓器規格請參考使用手冊。
- cn** 警告! 只能使用经过认证, 适用于本系统的电源适配器与电源线。使用不适用的电源适配器将可能导致火灾或爆炸。电源适配器规格请参考使用手册。

-
- en** Warning! Ultimate disposal of this product should be handled according to all national laws and regulations.
- de** Vorsicht! Die Entsorgung dieses Produkts sollte gemäß allen Bestimmungen und Gesetzen des Landes erfolgen.
- fr** Attention! La mise au rebut ou le recyclage de ce produit sont généralement soumis aux lois et/ou directives de respect de l'environnement. Renseignez-vous auprès de l'organisme compétent.
- it** Avvertenza! Lo smaltimento di questo prodotto deve essere eseguito secondo le leggi e i regolamenti locali.
- es** Atención! La disposición final de residuos de este producto se debe cumplir con las normativas y leyes del país.
- zh** 警告! 本產品的廢棄處理應根據該國家的法律和規章進行。
- cn** 警告! 本产品的废弃处理应根据该国家的法律和规章进行。
-

Copyright

COPYRIGHT NOTICE

The information in this document is subject to change without prior notice in order to improve reliability, design and function and does not represent a commitment on the part of the manufacturer.

In no event will the manufacturer be liable for direct, indirect, special, incidental, or consequential damages arising out of the use or inability to use the product or documentation, even if advised of the possibility of such damages.

This document contains proprietary information protected by copyright. All rights are reserved. No part of this manual may be reproduced by any mechanical, electronic, or other means in any form without prior written permission of the manufacturer.

TRADEMARKS

All registered trademarks and product names mentioned herein are used for identification purposes only and may be trademarks and/or registered trademarks of their respective owners.

Manual Conventions



WARNING

Warnings appear where overlooked details may cause damage to the equipment or result in personal injury. Warnings should be taken seriously.



CAUTION

Cautionary messages should be heeded to help reduce the chance of losing data or damaging the product.



NOTE

These messages inform the reader of essential but non-critical information. These messages should be read carefully as any directions or instructions contained therein can help avoid making mistakes.



HOT SURFACE

This symbol indicates a hot surface that should not be touched without taking care.

Table of Contents

| | |
|---|-----------|
| 1 INTRODUCTION..... | 15 |
| 1.1 OVERVIEW..... | 16 |
| 1.2 MODEL VARIATIONS | 16 |
| 1.3 FEATURES..... | 17 |
| 1.4 FRONT PANEL..... | 17 |
| 1.5 REAR PANEL | 17 |
| 1.6 BOTTOM PANEL | 18 |
| 1.7 SYSTEM SPECIFICATIONS..... | 19 |
| 1.7.1 WLAN/Bluetooth Frequency Range and Power..... | 21 |
| 1.8 DIMENSIONS..... | 22 |
| 1.8.1 AFL4-W10-EHL Dimensions | 22 |
| 1.8.2 AFL4-W12-EHL Dimensions | 23 |
| 1.8.3 AFL4-12-EHL Dimensions | 24 |
| 1.8.4 AFL4-W13-EHL Dimensions | 25 |
| 2 UNPACKING | 26 |
| 2.1 UNPACKING..... | 27 |
| 2.2 PACKING LIST | 28 |
| 2.3 OPTIONAL ITEMS | 29 |
| 3 INSTALLATION | 30 |
| 3.1 ANTI-STATIC PRECAUTIONS..... | 31 |
| 3.2 INSTALLATION PRECAUTIONS | 31 |
| 3.3 INSTALLATION AND CONFIGURATION STEPS | 32 |
| 3.4 REMOVING THE BACK COVER | 32 |
| 3.5 M.2 MODULE INSTALLATION..... | 33 |
| 3.6 CLEAR CMOS..... | 34 |
| 3.7 AT/ATX MODE SELECTION..... | 35 |
| 3.7.1 AT Power Mode..... | 35 |
| 3.7.2 ATX Power Mode | 36 |
| 3.8 MOUNTING THE SYSTEM | 36 |

| | | |
|----------|---|-----------|
| 3.8.1 | <i>Wall Mounting</i> | 36 |
| 3.8.2 | <i>Arm Mounting</i> | 39 |
| 3.8.3 | <i>Stand Mounting</i> | 41 |
| 3.8.4 | <i>V-Stand Mounting</i> | 41 |
| 3.9 | POWERING ON THE SYSTEM..... | 43 |
| 3.10 | RESET THE SYSTEM..... | 44 |
| 3.11 | SOFTWARE INSTALLATION..... | 44 |
| 3.11.1 | <i>Driver Download</i> | 45 |
| 3.11.2 | <i>Adjust Brightlight</i> | 46 |
| 4 | SYSTEM MAINTENANCE | 47 |
| 4.1 | SYSTEM MAINTENANCE INTRODUCTION..... | 48 |
| 4.2 | ANTI-STATIC PRECAUTIONS..... | 48 |
| 4.3 | TURN OFF THE POWER..... | 49 |
| 4.4 | WLAN CARD REPLACEMENT..... | 49 |
| 4.5 | REINSTALLING THE COVER..... | 51 |
| 5 | BIOS | 52 |
| 5.1 | INTRODUCTION..... | 53 |
| 5.1.1 | <i>Starting Setup</i> | 53 |
| 5.1.2 | <i>Using Setup</i> | 54 |
| 5.1.3 | <i>Getting Help</i> | 56 |
| 5.1.4 | <i>Unable to Reboot after Configuration Changes</i> | 56 |
| 5.1.5 | <i>BIOS Menu Bar</i> | 56 |
| 5.2 | MAIN..... | 57 |
| 5.3 | ADVANCED..... | 61 |
| 5.3.1 | <i>CPU Configuration</i> | 62 |
| 5.3.2 | <i>Trusted Computing</i> | 66 |
| 5.3.3 | <i>F81966 Super IO Configuration</i> | 67 |
| 5.3.4 | <i>EC KB9068 H/W Monitor</i> | 74 |
| 5.3.5 | <i>Serial Port Console Redirection</i> | 78 |
| 5.3.6 | <i>NVMe Configuration</i> | 82 |
| 5.4 | CHIPSET..... | 83 |
| 5.4.1 | <i>System Agent (SA) Configuration</i> | 84 |
| 5.4.2 | <i>PCH-IO Configuration</i> | 89 |

AFL4-W10/W12/12/W13-EHL Panel PC

| | |
|--|------------|
| 5.5 SECURITY..... | 96 |
| 5.6 BOOT..... | 98 |
| 5.6.1 Boot Configuration | 98 |
| 5.6.2 Boot Option Priorities..... | 99 |
| 5.7 SAVE & EXIT | 100 |
| 6 CONNECTORS | 102 |
| 6.1 PERIPHERAL INTERFACE CONNECTORS..... | 103 |
| 6.2 INTERNAL PERIPHERAL CONNECTORS | 104 |
| 6.2.1 Touch Panel Connector (TOUCH_USB1) | 104 |
| 6.2.2 Flash SPI ROM Connector (JBIOS1) | 105 |
| 6.2.3 EC Debug Port Connector (EC_DEBUG1) | 105 |
| 6.2.4 Speaker Connector (SPK_L1)..... | 105 |
| 6.2.5 RFID Connector (RFID_USB1) | 105 |
| 6.2.6 Digital MIC Connector (DMIC1) | 106 |
| 6.2.7 I ² C Connector (I2C1)..... | 106 |
| 6.2.8 SMBus Connector (SMB1)..... | 106 |
| 6.2.9 Battery Connector (BAT1) | 106 |
| 6.2.10 M.2 A-Key Slot (M2_AE1) | 106 |
| 6.2.11 M.2 M-Key Slot (M2_M1) | 108 |
| 6.2.12 M.2 M-Key Slot (M2_M2)..... | 109 |
| 6.2.13 eDP Connector (EDP1) | 110 |
| 6.2.14 LVDS Connector (LCD1)..... | 111 |
| 6.2.15 LVDS Backlight Power (INV1) | 111 |
| 6.2.16 CPU Fan Connector (CPU_FAN1)..... | 112 |
| 6.3 JUMPER LESS SETTING..... | 112 |
| 6.3.1 PWM Power Selection (J_PWM1)..... | 112 |
| 6.3.2 Backlight Enable Selection (J_BL_EN)..... | 112 |
| 6.3.3 Backlight VCC Selection (J_BL_VCC)..... | 113 |
| 6.3.4 LVDS Power Selection (J_VLVDS1)..... | 113 |
| 6.3.5 Flash Descriptor Security Override..... | 113 |
| 6.4 EXTERNAL INTERFACE PANEL CONNECTORS..... | 113 |
| 6.4.1 RS-232/422/485 Serial Ports (COM1/2/3/4) | 114 |
| 6.4.2 RJ45 LAN Connector (J_LAN1/2) | 114 |
| 6.4.1 HDMI Connector (HDMI1) | 114 |

| | |
|--|-----|
| 6.4.2 USB 2.0 Connectors (USB2_CON1/2/3) | 115 |
| 6.4.3 USB 3.2 Gen 2 Connectors (USB3_CON12)..... | 115 |
| 6.4.4 Power Button (PWR_SW1) | 116 |
| 6.4.5 DC Jack..... | 116 |

List of Figures

| | |
|---|----|
| Figure 1-1: AFL4-W10/W12/12/W13 Panel PC | 16 |
| Figure 1-2: Front View | 17 |
| Figure 1-3: Rear View | 18 |
| Figure 1-4: Front Bottom Panel | 18 |
| Figure 1-5: Left Bottom Panel | 18 |
| Figure 1-6: Right Bottom Panel | 19 |
| Figure 1-7: AFL4-W10-EHL Dimensions (mm) | 22 |
| Figure 1-8: AFL4-W12-EHL Dimensions (mm) | 23 |
| Figure 1-9: AFL4-12-EHL Dimensions (mm) | 24 |
| Figure 1-10: AFL4-W13-EHL Dimensions (mm) | 25 |
| Figure 3-1: Back Cover Retention Screws | 33 |
| Figure 3-2: Remove the Back Cover | 33 |
| Figure 3-3: M.2 Module Slot Location | 34 |
| Figure 3-4: M.2 Module Installation | 34 |
| Figure 3-5: Clear CMOS Button Location | 35 |
| Figure 3-6: AT/ATX Switch Location | 35 |
| Figure 3-7: Wall-mounting Bracket | 37 |
| Figure 3-8: Chassis Support Screws | 38 |
| Figure 3-9: Secure the Panel PC | 39 |
| Figure 3-10: Arm Mounting Retention Screw Holes | 40 |
| Figure 3-11: Arm Mounting | 40 |
| Figure 3-12: Stand Mounting (Stand-Cxx) | 41 |
| Figure 3-13: Drill Pilot Holes for V-Stand | 42 |
| Figure 3-14: Secure V-Stand to System | 42 |
| Figure 3-15: Secure V-Stand to Mounting Area | 43 |
| Figure 3-16: Power Button | 44 |
| Figure 3-17: Reset Button Location | 44 |
| Figure 3-18: IEI Resource Download Center | 45 |
| Figure 3-19: Keypad AP | 46 |
| Figure 4-1: WLAN Module Location | 49 |
| Figure 4-2: Releasing the WLAN Module | 50 |

| | |
|--|------------|
| Figure 4-3: Removing the WLAN Module | 50 |
| Figure 5-1: BIOS Starting Menu | 53 |
| Figure 5-1: Main Board Layout Diagram (Front Side) | 103 |
| Figure 5-2: Main Board Layout Diagram (Solder Side) | 103 |

List of Tables

| | |
|--|-----|
| Table 1-1: Model Variation | 16 |
| Table 1-2: System Specifications..... | 21 |
| Table 1-3: WLAN/Bluetooth Frequency Range and Power..... | 21 |
| Table 2-1: Packing List..... | 28 |
| Table 2-2: Optional Items | 29 |
| Table 5-1: BIOS Navigation Keys | 54 |
| Table 5-2: BIOS On-screen Navigation Keys | 55 |
| Table 5-1: Peripheral Interface Connectors | 104 |
| Table 5-2: Touch Panel Connector (TOUCH_USB1) Pinouts | 104 |
| Table 5-3: Flash SPI ROM Connector (JBIOS1) Pinouts..... | 105 |
| Table 5-4: EC Debug Port Connector (EC_DEBUG1) Pinouts | 105 |
| Table 5-5: Speaker Connector (SPK_L1) Pinouts | 105 |
| Table 5-6: RFID Connector (RFID_USB1) Pinouts..... | 105 |
| Table 5-7: Digital MIC Connector (DMIC1) Pinouts | 106 |
| Table 5-8: I ² C Connector (I2C1) Pinouts..... | 106 |
| Table 5-9: SMBus Connector (SMB1) Pinouts | 106 |
| Table 5-10: Battery Connector (BAT1) Pinouts | 106 |
| Table 5-11: M.2 A-Key Slot (M2_AE1) Pinouts..... | 108 |
| Table 5-12: M.2 M-Key Slot (M2_M1) Pinouts | 109 |
| Table 5-13: M.2 M-Key Slot (M2_M2) Pinouts | 110 |
| Table 5-14: eDP Connector (EDP1) Pinouts..... | 111 |
| Table 5-15: LVDS Connector (LCD1) Pinouts | 111 |
| Table 5-16: LVDS Backlight Power (INV1) Pinouts | 112 |
| Table 5-17: CPU Fan Connector (CPU_FAN1) Pinouts..... | 112 |
| Table 5-18: Jumper less Setting..... | 112 |
| Table 5-19: PWM Power Selection (J_PWM1)..... | 112 |
| Table 5-20: Backlight Enable Selection (J_BL_EN) | 112 |
| Table 5-21: Backlight VCC Selection (J_BL_VCC)..... | 113 |
| Table 5-22: LVDS Power Selection (J_VLVDS1)..... | 113 |
| Table 5-23: Flash Descriptor Security Override | 113 |
| Table 5-24: External Interface Panel Connectors..... | 113 |

| | |
|--|------------|
| Table 5-25: External Serial Port Connector (COM1/2/3/4) Pinouts | 114 |
| Table 5-26: LAN Connector (J_LAN1/2) Pinouts | 114 |
| Table 5-27: HDMI1 Connector (HDMI1) Pinouts..... | 115 |
| Table 5-28: USB 2.0 Connectors (USB2_CON1/2/3) Pinouts..... | 115 |
| Table 5-29: USB 3.2 Gen 2 Connectors (USB3_CON12) Pinouts..... | 115 |
| Table 5-30: Power Button (PWR_SW1) Pinouts | 116 |
| Table 5-31: DC Jack Connector..... | 116 |

Chapter

1

Introduction

1.1 Overview



Figure 1-1: AFL4-W10/W12/12/W13 Panel PC

The **AFL4-W10/W12/12/W13-EHL** is an Intel® Celeron® Processor J6412 powered panel PC with a rich variety of functions and peripherals.

The Intel® Celeron® Processor J6412 is a SoC (System-on-Chip) that ensures optimal memory, graphics, and peripheral I/O support. The system comes with 8GB on-board dual-channel LPDDR4x RAM ensuring smooth data throughputs with reduced bottlenecks and fast system access.

Two serial ports and two external USB 3.2 Gen 2 ports ensure simplified connectivity to a variety of external peripheral devices.

1.2 Model Variations

The model number and model variation are listed below.

| Model | Size | Resolution |
|-------------------------------|---------------|-------------|
| AFL4-W10-EHL-J1/8G-R10 | 10.1" | 1280 x 800 |
| AFL4-W12-EHL-J1/8G-R10 | 12.1" (16:10) | 1280 x 800 |
| AFL4-12-EHL-J1/8G-R10 | 12.1" (4:3) | 1024 x 768 |
| AFL4-W13-EHL-J1/8G-R10 | 13.3" | 1920 x 1080 |

Table 1-1: Model Variation

AFL4-W10/W12/12/W13-EHL Panel PC

1.3 Features

The AFL4-W10/W12/12/W13-EHL features are listed below:

- Intel® Celeron® Processor J6412
- Preinstalled with 8GB on-board dual-channel LPDDR4x RAM
- Anti-glare and anti-UV touchscreen
- FHD touch display with optical bonding
- IP 64 compliant front panel
- One M.2 M key 2280 & One M.2 M key 2242
- Two 2.5 GbE Ethernet port
- Two USB 3.2 Gen 2
- Two RS-232/422/485 by DB9

1.4 Front Panel

The front side of the AFL4-W10/W12/12/W13-EHL is a panel LCD touchscreen surrounded by an aluminum frame (**Figure 1-2**).



Figure 1-2: Front View

1.5 Rear Panel

The rear panel provides access to retention screw holes that support VESA 75/100 mounting. See **Figure 1-3**.

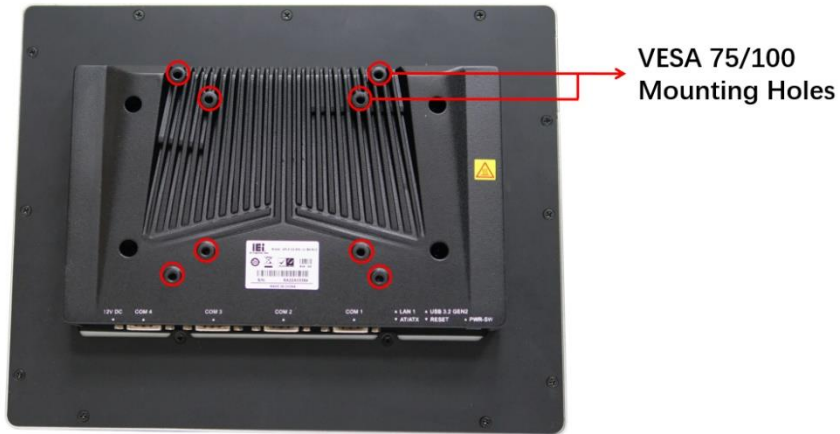

Figure 1-3: Rear View

1.6 Bottom Panel

The bottom panel of the AFL4-W10/W12/12/W13-EHL has the following connectors and switches.

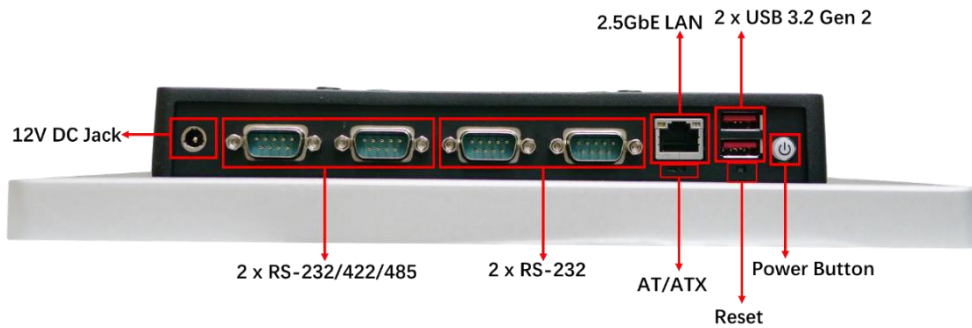

Figure 1-4: Front Bottom Panel

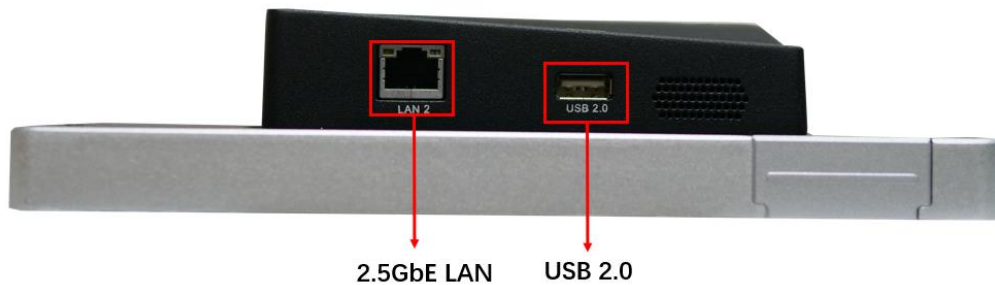

Figure 1-5: Left Bottom Panel

AFL4-W10/W12/12/W13-EHL Panel PC

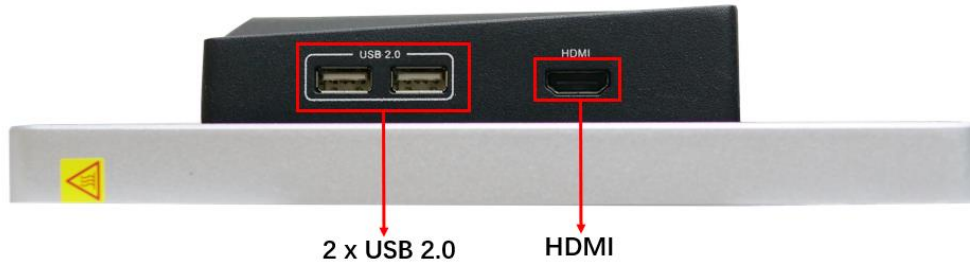

Figure 1-6: Right Bottom Panel



NOTE:

Before installing the operating system, the user must enter the **Boot** BIOS menu first and choose which operating system will be installed. Otherwise the USB 3.2 Gen 2 ports cannot be used for OS installation.

1.7 System Specifications

The technical specifications for the AFL4-W10/W12/12/W13-EHL systems are listed in Table 1-2.

| Specification | AFL4-W10-EHL | AFL4-W12-EHL | AFL4-12-EHL | AFL4-W13-EHL |
|---------------------------------|--|-----------------|-------------|---------------|
| LCD Size | 10.1" (16:10) | 12.1" (16:10) | 12" (4:3) | 13.3" (16:10) |
| Max. Resolution | 1280 x 800 | 1280 x 800 | 1024 x 768 | 1920 x1080 |
| Brightness (cd/m ²) | 350 | 500 | 500 | 350 |
| LCD Color | 16.7M | 16.7M | 16.7M | 16.7M |
| Pixel Pitch (mm) | 0.1695 x 0.1695 | 0.1695 x 0.1695 | 0.24 x 0.24 | 0.153 x 0.153 |
| Contrast Ratio | 900:1 | 1200:1 | 700:1 | 800:1 |
| Viewing Angle (H-V) | 170°/170° | 170°/170° | 160°/140° | 170°/170° |
| Backlight MTBF | 30000 hours | 50000 hours | 50000 hours | 50000 hours |
| Touchscreen | PCAP with USB interface (anti-UV/AG coating) | | | |

| | |
|---------------------------------|--|
| Touch Controller | EETI EXC 81 Series |
| CPU (SoC) | Intel® Celeron® Processor J6412 1.5M Cache, up to 2.60 GHz / TDP 10W |
| RAM | 8GB on-board dual-channel LPDDR4x RAM |
| Ethernet | LAN1: Intel® I225V 2.5GbE controller LAN2: Intel® I225V 2.5GbE controller |
| Expansion | 1 x M.2 M key 2242 (PCIe Gen3 x1) 1 x M.2 M key 2242/2280 (PCIe Gen3 x1 + SATA) |
| Audio | Realtek ALC888S |
| Internal Speaker | AMP 1.2 W |
| Wireless & Bluetooth | IEEE 802.11ax 2T2R module (Wi-Fi 6E) with BT v5.2 (M.2 2230 A-key) |
| Construction | Aluminum die casting |
| Mounting | Wall, Stand, ARM, VESA 75/100 |
| Color | Silver + Black |
| Operating Temperature | -10 ~ 50 °C |
| Storage Temperature | -20°C ~ 60°C |
| Humidity | 10% ~ 95%@40°C (non-condensing) |
| IP Level | IP 64 compliant front panel |
| Safety/EMC | CE/EMC, FCC, RED (Class A), UKCA |
| Power Requirement | 12V |
| Thermal Solution | Fanless |
| OS | Windows/Linux |
| ErP | ErP 2009/125/EC |

AFL4-W10/W12/12/W13-EHL Panel PC

| | |
|-------------------------------|---------------------------|
| I/O Ports and Switches | 2 x 2.5GbE LAN |
| | 2 x RS-232/422/485 by DB9 |
| | 2 x RS-232 by DB9 |
| | 3 x USB 2.0 |
| | 2 x USB 3.2 Gen 2 |
| | 1 x HDMI output |
| | 1 x Power button |
| | 1 x AT/ATX switch |
| | 1 x Reset button |
| | 1 x 12V DC input jack |

Table 1-2: System Specifications

1.7.1 WLAN/Bluetooth Frequency Range and Power

| Technology | Frequency range/MHz | Max.E.I.R.P/dBm |
|------------------|---------------------|-----------------|
| WLAN 2.4GHz | 2400-2483.5 | 20 |
| WLAN 5GHz | 5150-5250 | 23 |
| WLAN 5GHz | 5250-5350 | 23 |
| WLAN 5GHz | 5470-5725 | 23 |
| WLAN 5GHz | 5725-5850 | 13.98 |
| WLAN 6GHz | 5945-6425 | 14 |
| Bluetooth BR/EDR | 2402-2480 | 10 |
| Bluetooth LE | 2402-2480 | 10 |

Table 1-3: WLAN/Bluetooth Frequency Range and Power

1.8 Dimensions

The AFL4-W10/W12/12/W13-EHL dimensions are shown below.

1.8.1 AFL4-W10-EHL Dimensions

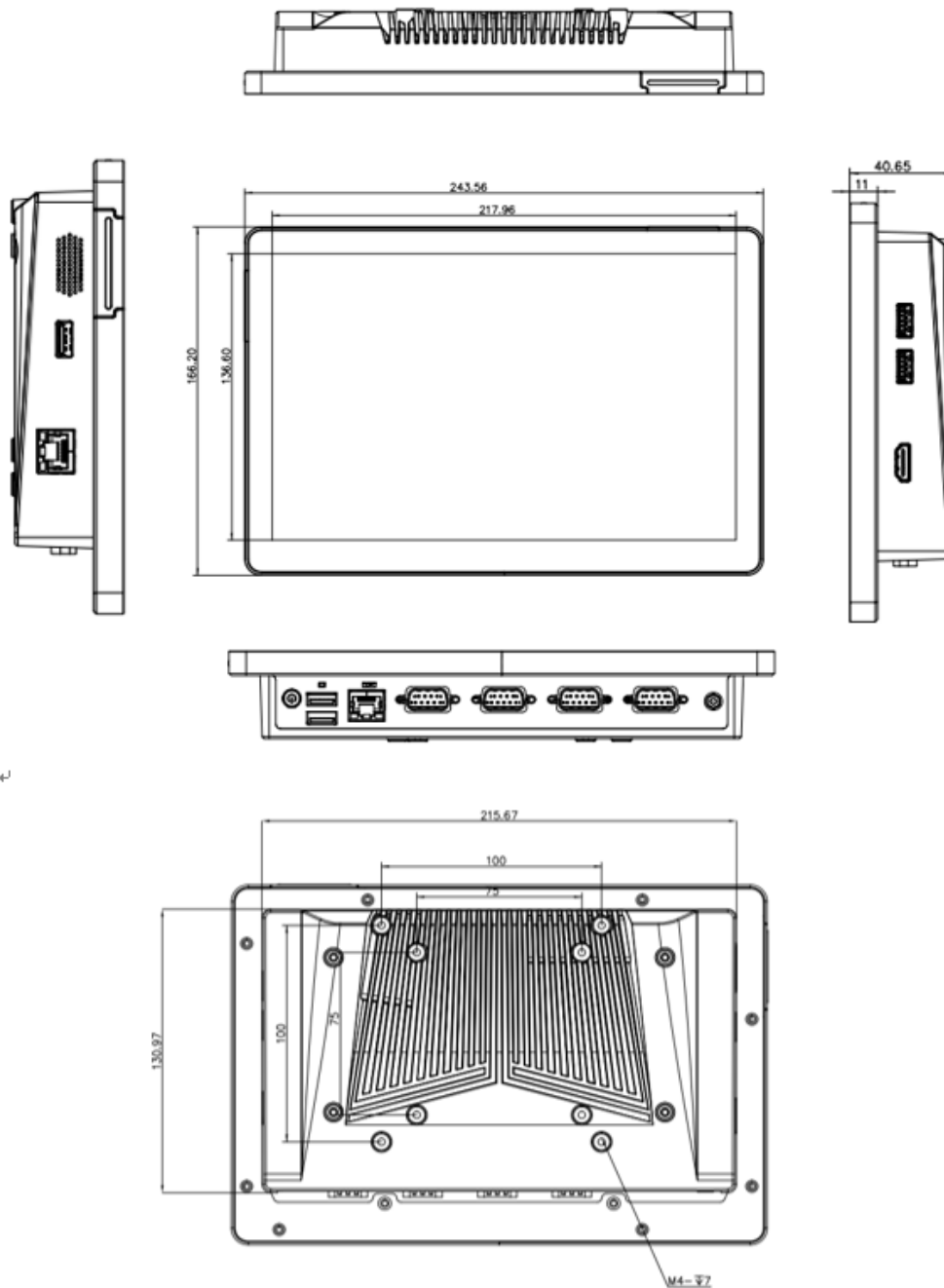

Figure 1-7: AFL4-W10-EHL Dimensions (mm)

AFL4-W10/W12/12/W13-EHL Panel PC

1.8.2 AFL4-W12-EHL Dimensions

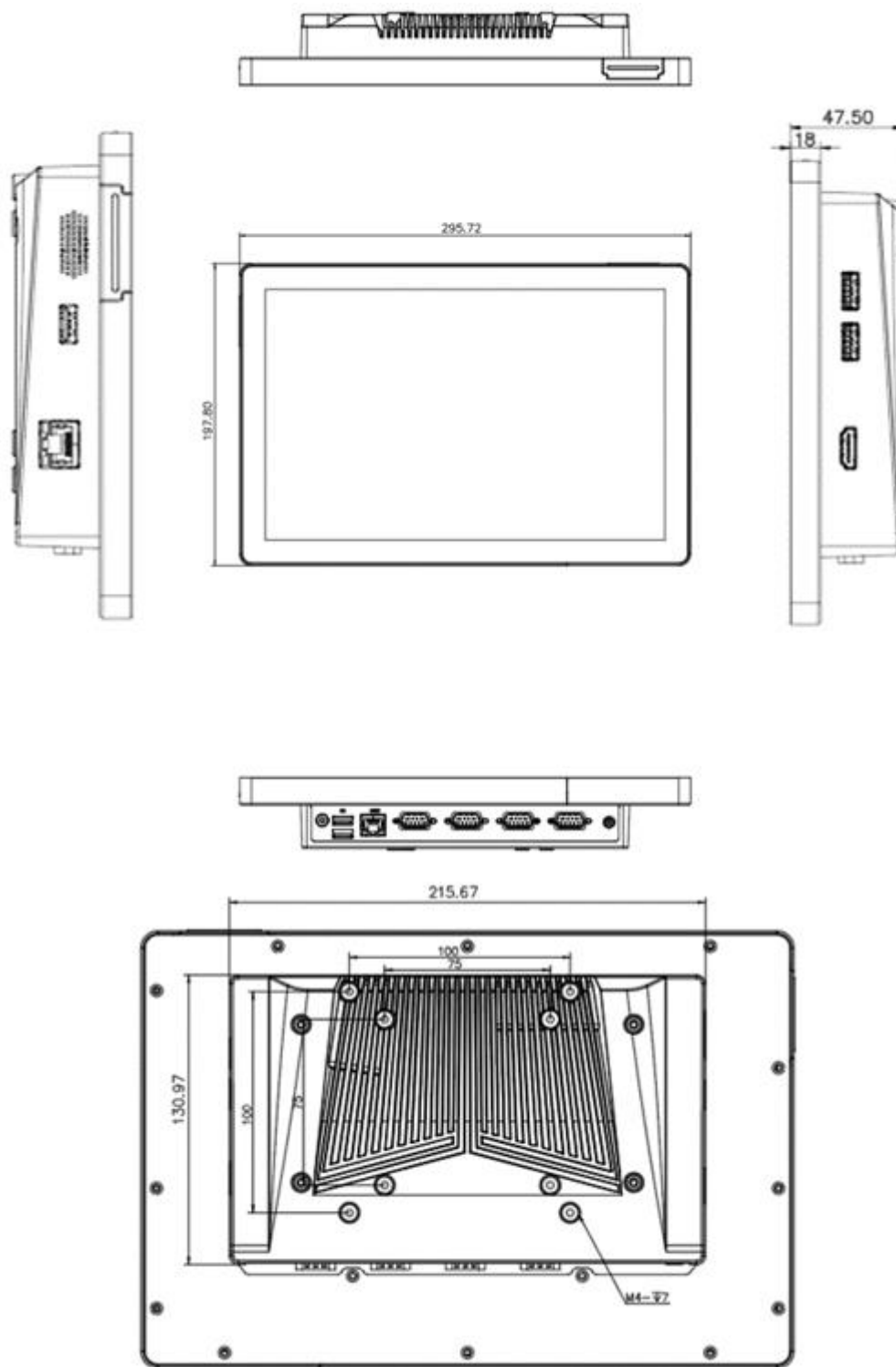

Figure 1-8: AFL4-W12-EHL Dimensions (mm)

1.8.3 AFL4-12-EHL Dimensions

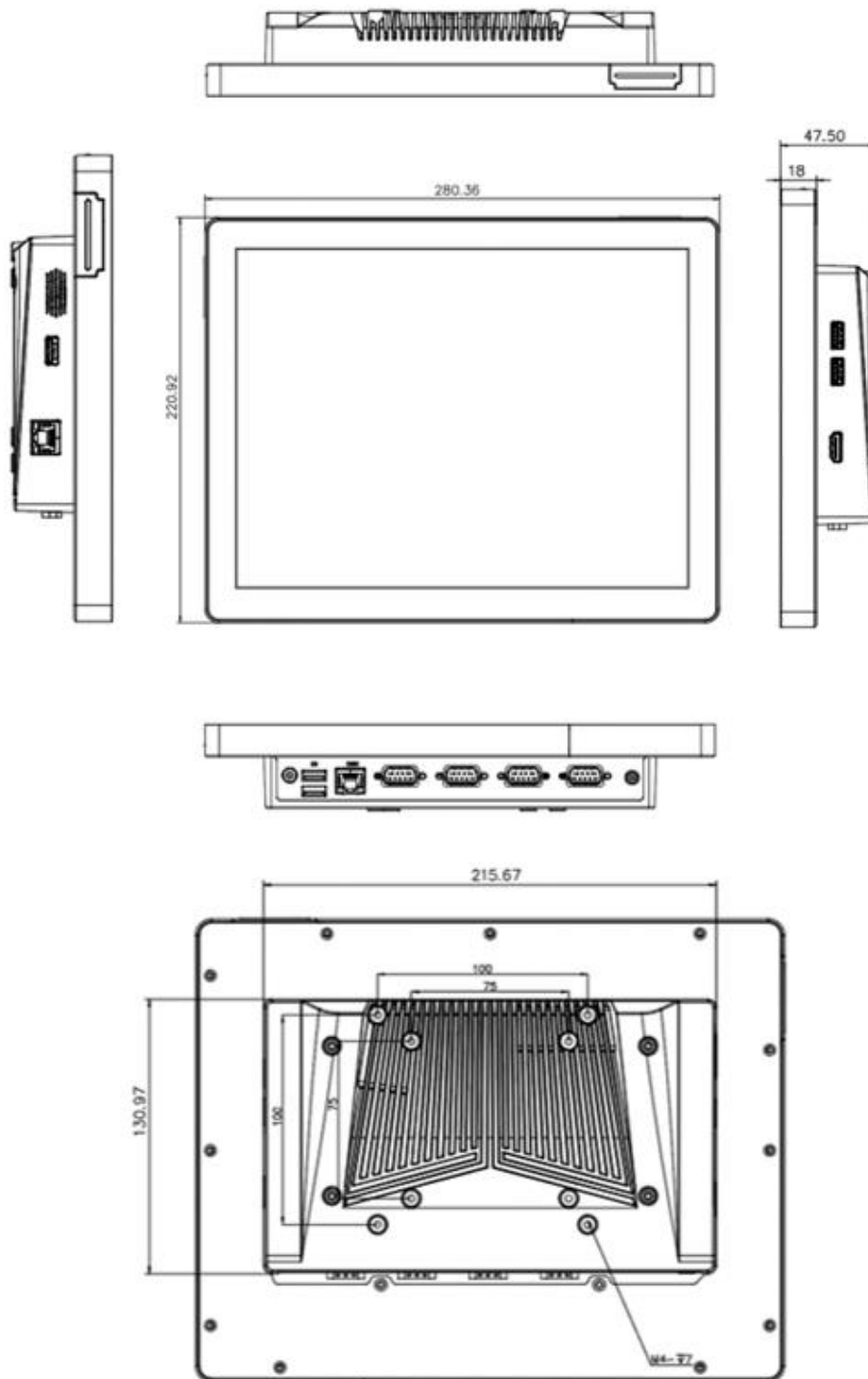

Figure 1-9: AFL4-12-EHL Dimensions (mm)

AFL4-W10/W12/12/W13-EHL Panel PC

1.8.4 AFL4-W13-EHL Dimensions

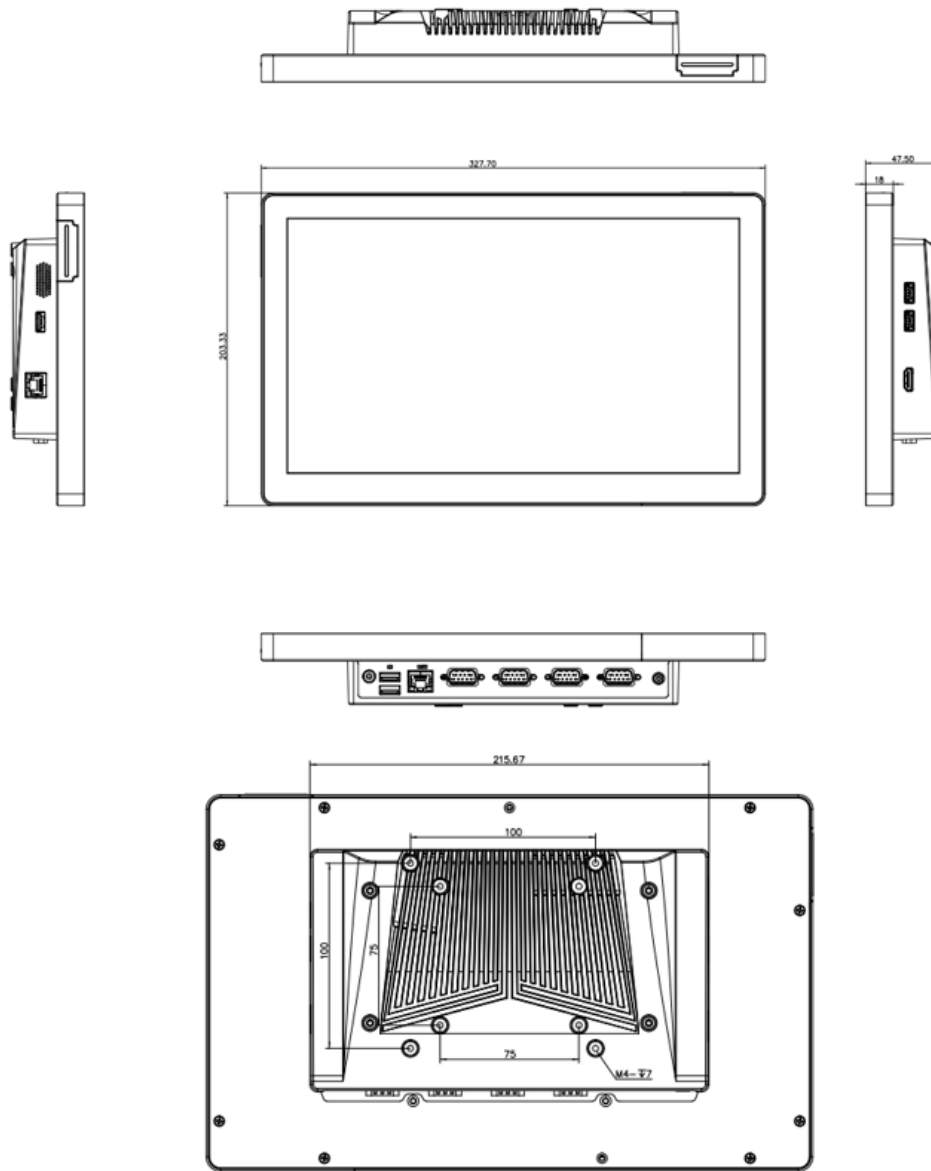

Figure 1-10: AFL4-W13-EHL Dimensions (mm)

Chapter

2

Unpacking

AFL4-W10/W12/12/W13-EHL Panel PC

2.1 Unpacking

To unpack the panel PC, follow the steps below:



WARNING!

The front side LCD screen has a protective plastic cover stuck to the screen. Only remove the plastic cover after the panel PC has been properly installed. This ensures the screen is protected during the installation process.

- Step 1:** Open the box.
- Step 2:** Lift the monitor out of the boxes.
- Step 3:** Remove both polystyrene ends, one from each side.
- Step 4:** Pull the plastic cover off the panel PC.
- Step 5:** Make sure all the components listed in the packing list are present.

2.2 Packing List



NOTE:

If any of the components listed in the checklist below are missing, do not proceed with the installation. Contact the IEI reseller or vendor the AFL4-W10/W12/12/W13-EHL was purchased from or contact an IEI sales representative directly by sending an email to sales@ieiworld.com.

The AFL4-W10/W12/12/W13-EHL panel PC is shipped with the following components:



| Quantity | Item | Image |
|----------|----------------------------------|--|
| 1 | AFL4-W10/W12/12/W13-EHL panel PC |  |
| 1 | 60 W power adapter |  |
| 1 | Power cord |  |

Table 2-1: Packing List

AFL4-W10/W12/12/W13-EHL Panel PC

2.3 Optional Items

The following are optional components which may be separately purchased:





| Item and Part Number | Image |
|--|---|
| VESA 75/100 wall mount kit (P/N: AFLWK-19B) |  |
| Arm (P/N: ARM-11-RS) |  |
| Stand for VESA 75/100 (P/N: STAND-C12-R10) |  |
| LCD monitor stand with adjustable hinge (P/N: VSTAND-A10-R11) |  |

Table 2-2: Optional Items

If any of these items are missing or damaged, contact the distributor or sales representative immediately.

Chapter

3

Installation

AFL4-W10/W12/12/W13-EHL Panel PC

3.1 Anti-static Precautions

**WARNING:**

Failure to take ESD precautions during the maintenance of the AFL4-W10/W12/12/W13-EHL may result in permanent damage to the AFL4-W10/W12/12/W13-EHL and severe injury to the user.

Electrostatic discharge (ESD) can cause serious damage to electronic components, including the AFL4-W10/W12/12/W13-EHL. Dry climates are especially susceptible to ESD. It is therefore critical that whenever AFL4-W10/W12/12/W13-EHL is accessed internally, or any other electrical component is handled, the following anti-static precautions are strictly adhered to.

- **Wear an anti-static wristband:** Wearing a simple anti-static wristband can help to prevent ESD from damaging the board.
- **Self-grounding:** Before handling the board, touch any grounded conducting material. During the time the board is handled, frequently touch any conducting materials that are connected to the ground.
- **Use an anti-static pad:** When configuring the AFL4-W10/W12/12/W13-EHL, place it on an anti-static pad. This reduces the possibility of ESD damaging the AFL4-W10/W12/12/W13-EHL.
- **Only handle the edges of the PCB:** When handling the PCB, hold the PCB by the edges.

3.2 Installation Precautions

When installing the panel PC, please follow the precautions listed below:

- **Power turned off:** When installing the panel PC, make sure the power is off. Failing to turn off the power may cause severe injury to the body and/or damage to the system.
- **Certified Engineers:** Never open the equipment. For safety reasons, the equipment should be opened only by qualified skilled person. Only certified engineers should install and modify onboard functionalities.

- **Anti-static Discharge:** If a user opens the rear panel of the panel PC, to configure the jumpers or plug in added peripheral devices, ground themselves first and wear an anti-static wristband.

3.3 Installation and Configuration Steps

The following installation steps must be followed.

Step 1: Unpack the panel PC.

Step 2: Install a M.2 module.

Step 3: Configure the system.

Step 4: Connect peripheral devices to the panel PC.

Step 5: Mount the panel PC.

3.4 Removing the Back Cover



WARNING:

Before any internal installation procedures are carried out on the system, make sure the system is turned off and cooled down for 15 minutes. Failing to turn off the system before opening it can cause permanent damage to the system and serious or fatal injury to the user.

To access the AFL4-W10/W12/12/W13-EHL internally the back cover must be removed.

To remove the back cover, please follow the steps below.

Step 1: Remove the retention screws from the back cover (**Figure 3-1**).

AFL4-W10/W12/12/W13-EHL Panel PC



Figure 3-1: Back Cover Retention Screws

Step 2: Slide the back cover toward the I/O panel until it is disengaged from the locking mechanism. Then, lift the back cover off the chassis. See **Figure 3-2**.



Figure 3-2: Remove the Back Cover

3.5 M.2 Module Installation

To install a M.2 module into the AFL4-W10/W12/12/W13-EHL, please follow the steps below:

Step 1: Remove the back cover. See **Section 3.4** above.

Step 2: Locate the M.2 card slot. Remove the preinstalled retention screw on the standoff of the M.2 card slot as shown in **Figure 3-3**.

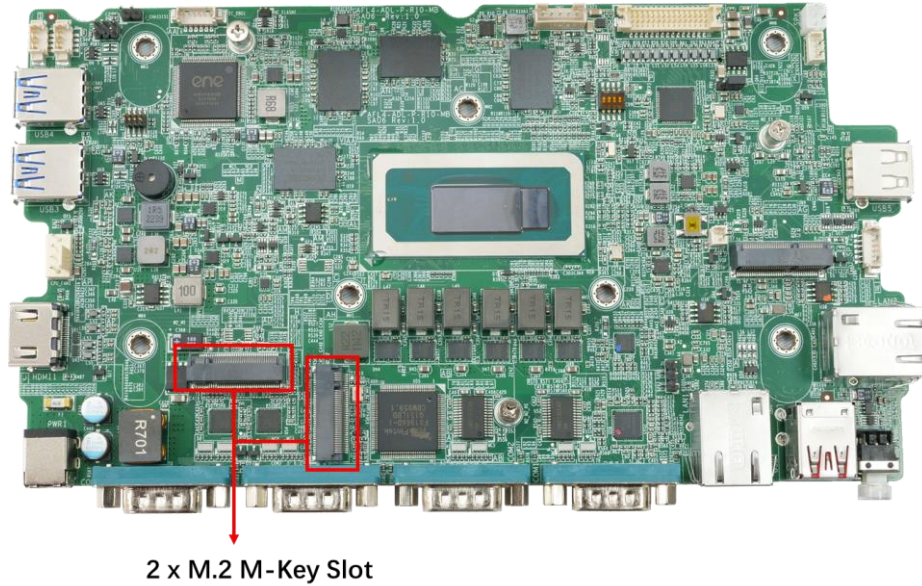

Figure 3-3: M.2 Module Slot Location

Step 3: Line up the notch on the M.2 module with the notch on the connector. Slide the M.2 module into the socket at an angle of about 20°.

Step 4: Secure the M.2 module with the retention screw. Push the other end of the M.2 module down and secure the module with the previously removed retention screw (**Figure 3-4**).

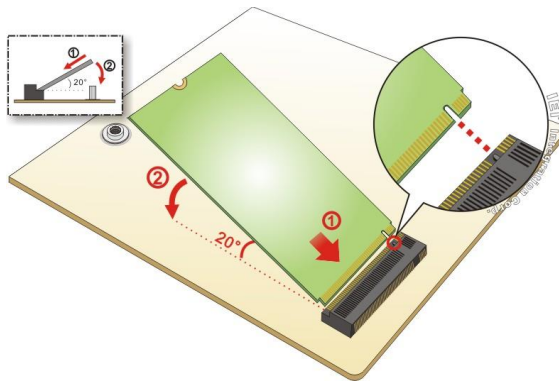

Figure 3-4: M.2 Module Installation

Step 5: Replace the back cover and secure it using retention screws.

3.6 Clear CMOS

AFL4-W10/W12/12/W13-EHL Panel PC

If the AFL4-W10/W12/12/W13-EHL fails to boot due to improper BIOS settings, the clear CMOS jumper clears the CMOS data and resets the system BIOS information. To do this, push the clear CMOS button for three seconds, then restart the system. The clear CMOS button location is shown in **Figure 3-5**.

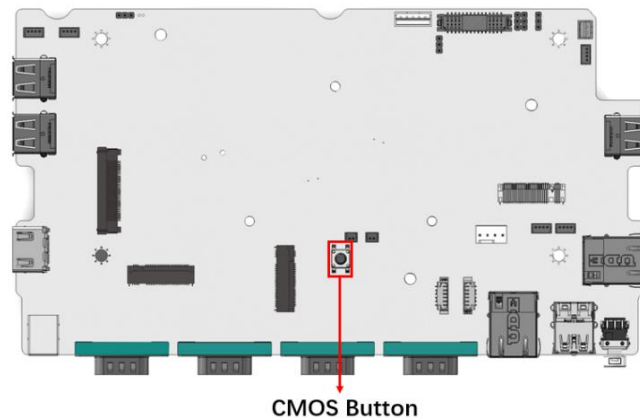

Figure 3-5: Clear CMOS Button Location

3.7 AT/ATX Mode Selection

AT or ATX power mode can be used on the AFL4-W10/W12/12/W13-EHL. The selection is made through an AT/ATX switch located on the bottom panel (**Figure 3-6**).



Figure 3-6: AT/ATX Switch Location

3.7.1 AT Power Mode

With the AT mode selected, the power is controlled by a central power unit rather than a power switch. The AFL4-W10/W12/12/W13-EHL panel PC turns on automatically when the power is connected. The AT mode benefits a production line to control multiple panel PCs from a central management center and other applications including:

- ATM

- Self-service kiosk
- Plant environment monitoring system
- Factory automation platform
- Manufacturing shop flow

3.7.2 ATX Power Mode

With the ATX mode selected, the AFL4-W10/W12/12/W13-EHL panel PC goes in a standby mode when it is turned off. The panel PC can be easily turned on via network or a power switch in standby mode. Remote power control is perfect for advertising applications since the broadcasting time for each panel PC can be set individually and controlled remotely. Other possible application includes:

- Security surveillance
- Point-of-Sale (POS)
- Advertising terminal

3.8 Mounting the System

The methods of mounting the AFL4-W10/W12/12/W13-EHL are listed below.

- Wall mounting
- Arm mounting
- Stand mounting
- V-Stand mounting

The mounting methods are described below.

3.8.1 Wall Mounting

To mount the panel PC onto the wall, please follow the steps below.

Step 1: Select the location on the wall for the wall-mounting bracket.

Step 2: Carefully mark the locations of the four screw holes in the bracket on the wall.

Step 3: Drill four pilot holes at the marked locations on the wall for the bracket retention screws.

AFL4-W10/W12/12/W13-EHL Panel PC

Step 4: Align the wall-mounting bracket screw holes with the pilot holes.

Step 5: Secure the mounting-bracket to the wall by inserting the retention screws into the four pilot holes and tightening them (**Figure 3-7**).

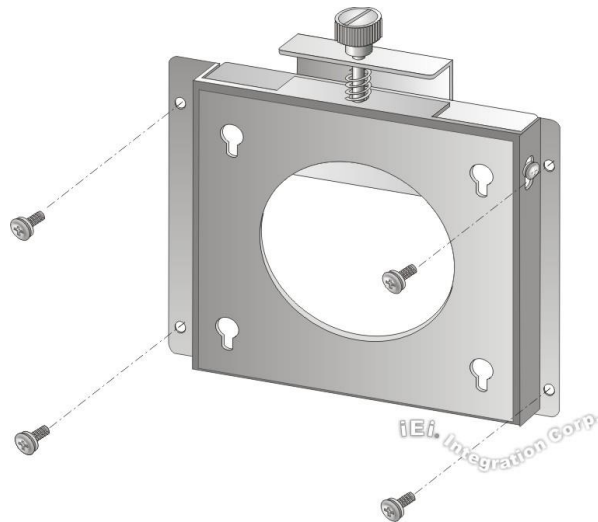

Figure 3-7: Wall-mounting Bracket

Step 6: Insert the four monitor mounting screws provided in the wall mount kit into the four screw holes on the rear panel of the panel PC and tighten until the screw shank is secured against the rear panel (**Figure 3-8**).



WARNING:

Please use the M4 screws provided in the wall mount kit for the rear panel. If the screw is missing, the thread depth of the replacement screw should be not more than 4 mm.

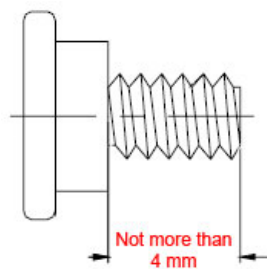

Step 7: Align the mounting screws on the monitor rear panel with the mounting holes on the bracket.

Step 8: Carefully insert the screws through the holes and gently pull the monitor downwards until the monitor rests securely in the slotted holes (**Figure 3-8**). Ensure that all four of the mounting screws fit snugly into their respective slotted holes. Always keep the AFL4-W10/W12/12/W13-EHL in landscape orientation when mounting on the wall.

**NOTE:**

In the diagram below the bracket is already installed on the wall.

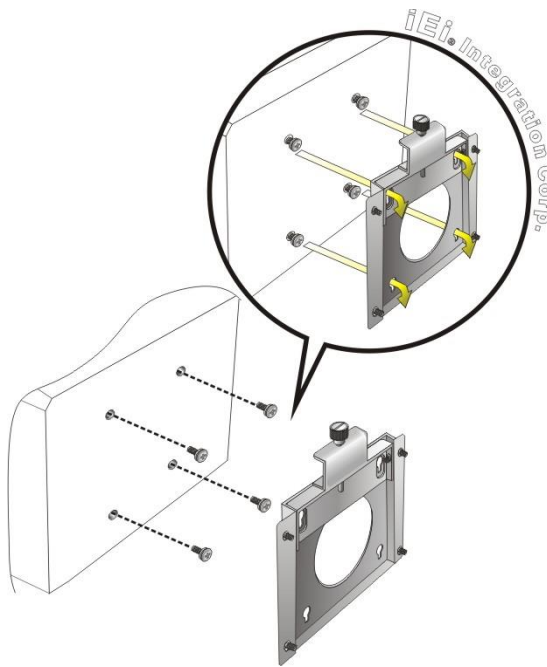

Figure 3-8: Chassis Support Screws

Step 9: Secure the panel PC by fastening the retention screw of the wall-mounting bracket (**Figure 3-9: Secure the Panel PC**).

AFL4-W10/W12/12/W13-EHL Panel PC

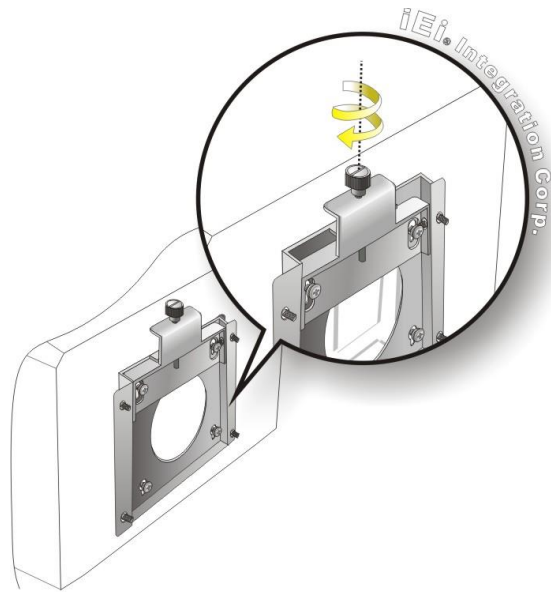

Figure 3-9: Secure the Panel PC

3.8.2 Arm Mounting

The AFL4-W10/W12/12/W13-EHL is VESA (Video Electronics Standards Association) compliant and can be mounted on an arm with a 75/100 mm interface pad. To mount the AFL4-W10/W12/12/W13-EHL on an arm, please follow the steps below.

Step 1: The arm is a separately purchased item. Please correctly mount the arm onto the surface it uses as a base. To do this, refer to the installation documentation that came with the mounting arm.



NOTE:

When purchasing the arm please ensure that it is VESA compliant and that the arm has a 75/100 mm interface pad. If the mounting arm is not VESA compliant it cannot be used to support the AFL4-W10/W12/12/W13-EHL panel PC.

Step 2: Once the mounting arm has been firmly attached to the surface, lift the panel PC onto the interface pad of the mounting arm.

Step 3: Align the retention screw holes on the mounting arm interface with those in the panel PC (**Figure 3-10**).

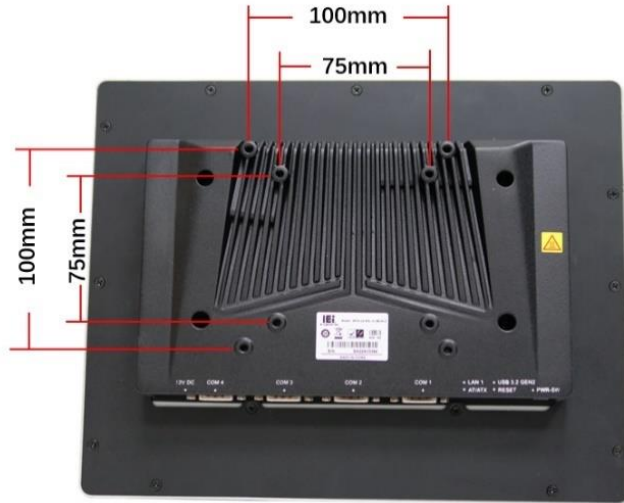

Figure 3-10: Arm Mounting Retention Screw Holes

Step 4: Secure the AFL4-W10/W12/12/W13-EHL to the interface pad by inserting four retention screws through the mounting arm interface pad and into the AFL4-W10/W12/12/W13-EHL.

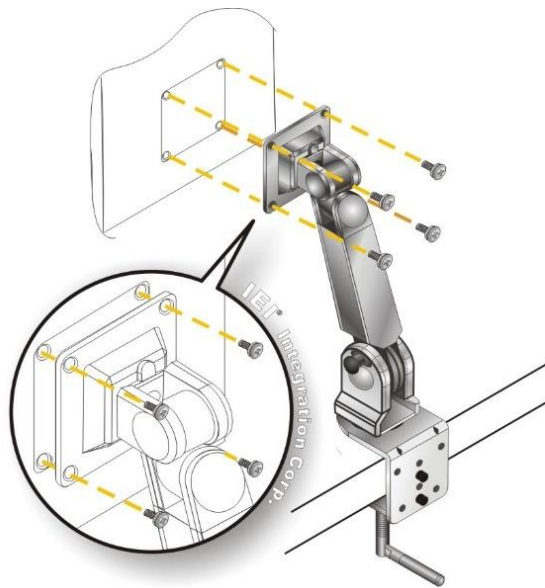

Figure 3-11: Arm Mounting

AFL4-W10/W12/12/W13-EHL Panel PC

3.8.3 Stand Mounting

To mount the AFL4-W10/W12/12/W13-EHL using the stand mounting kit, please follow the steps below.

Step 1: Locate the screw holes on the rear of the AFL4-W10/W12/12/W13-EHL. This is where the bracket will be attached.

Step 2: Align the bracket with the screw holes.

Step 3: To secure the bracket to the AFL4-W10/W12/12/W13-EHL insert the retention screws into the screw holes and tighten them.

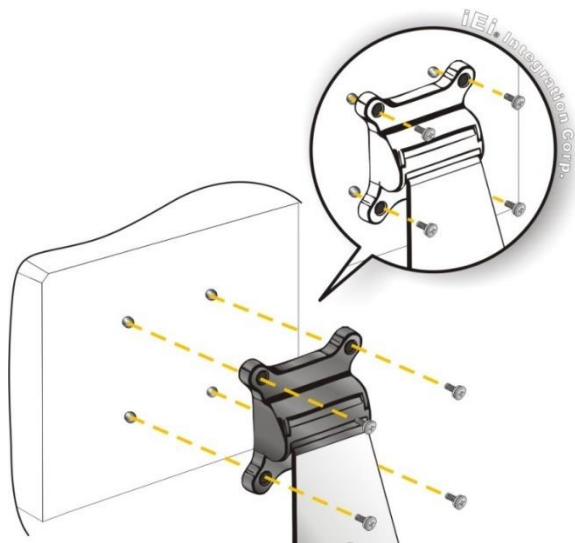

Figure 3-12: Stand Mounting (Stand-Cxx)

3.8.4 V-Stand Mounting

To mount the AFL4-W10/W12/12/W13-EHL using the optional V-Stand mounting kit, please follow the steps below.

Step 1: Carefully mark the locations of the four V-Stand screw holes on the mounting area. Drill four pilot holes at the marked locations for the V-Stand retention screws.

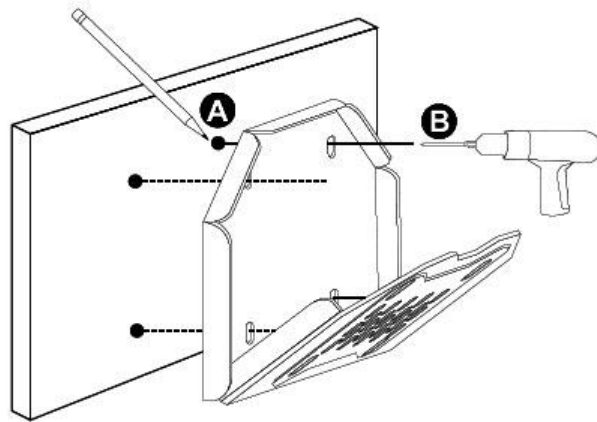

Figure 3-13: Drill Pilot Holes for V-Stand

- Step 2:** Align the screw holes on the V-Stand with the VESA mount screw holes on the system rear panel.
- Step 3:** Insert the four VESA mount screws into the four screw holes on the system rear panel. Adjust the V-Stand to a proper position.
- Step 4:** Tighten until the screw shank is secured against the rear panel.

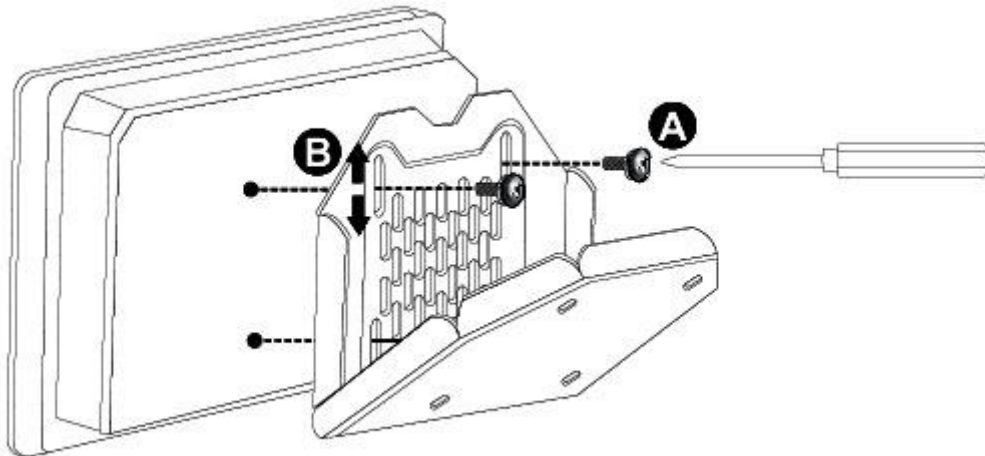

Figure 3-14: Secure V-Stand to System

- Step 5:** Align the V-Stand screw holes with the pilot holes on the mounting area. Mount the V-Stand by inserting the retention screws into the four pilot holes and tightening them.

AFL4-W10/W12/12/W13-EHL Panel PC

Step 6: Adjust the V-Stand to have a best viewing angle to operate the system.

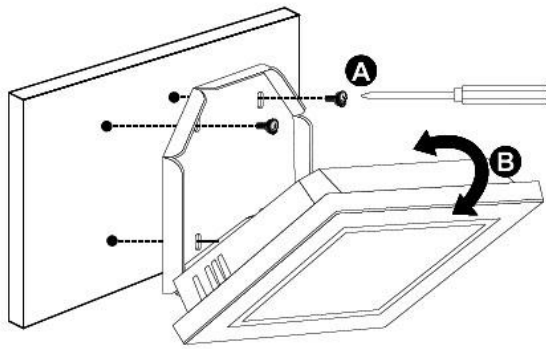

Figure 3-15: Secure V-Stand to Mounting Area

3.9 Powering on the System



WARNING:

To reduce potential safety issues, only the power adapter provided with the product, a replacement power adapter provided by IEI, or a power adapter purchased as an accessory from IEI should be used with the product.

To power on the system, follow the steps below:

- Step 1:** Connect the power cord to the power adapter. Connect the other end of the power cord to a power source. Ensure to connect the power cord to a socket-outlet with earthing connection.
- Step 2:** Connect the power adapter to the power connector of the AFL4-W10/W12/12/W13-EHL. The power LED turns on in amber.
- Step 3:** Locate the power button on the I/O panel.
- Step 4:** Hold down the power button until the power LED on the front panel turns to green.



Figure 3-16: Power Button

3.10 Reset the System

The reset button enables user to reboot the system when the system is turned on. The reset button location is shown in **Figure 3-17**. Press the reset button to reboot the system.



Figure 3-17: Reset Button Location

3.11 Software Installation

All the drivers for the AFL4-W10/W12/12/W13-EHL are available on IEI Resource Download Center (<https://download.ieiworld.com>). Type AFL4-W10/W12/12/W13-EHL and press Enter to find all the relevant software, utilities, and documentation.

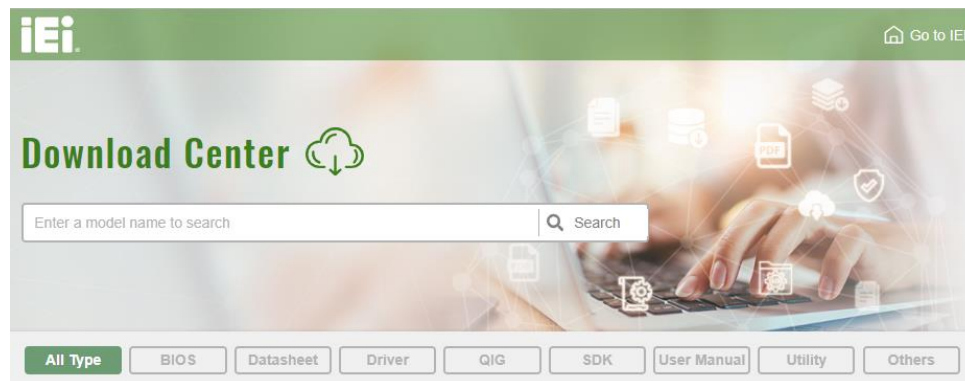

AFL4-W10/W12/12/W13-EHL Panel PC

Figure 3-18: IEI Resource Download Center

3.11.1 Driver Download

To download drivers from IEI Resource Download Center, follow the steps below.

Step 1: Go to <https://download.ieiworld.com>. Type AFL4-W10/W12/12/W13-EHL and press Enter.

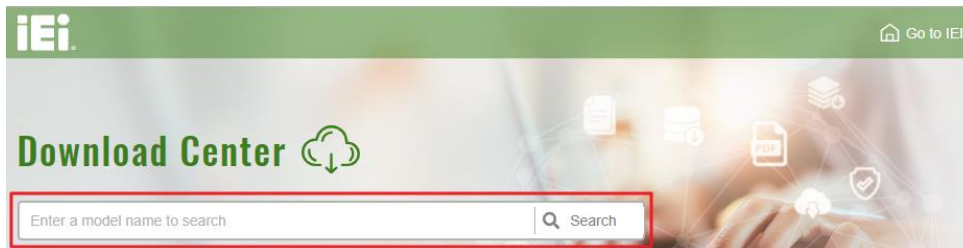

Step 2: All product-related software, utilities, and documentation will be listed. You can choose **Driver** to filter the result.

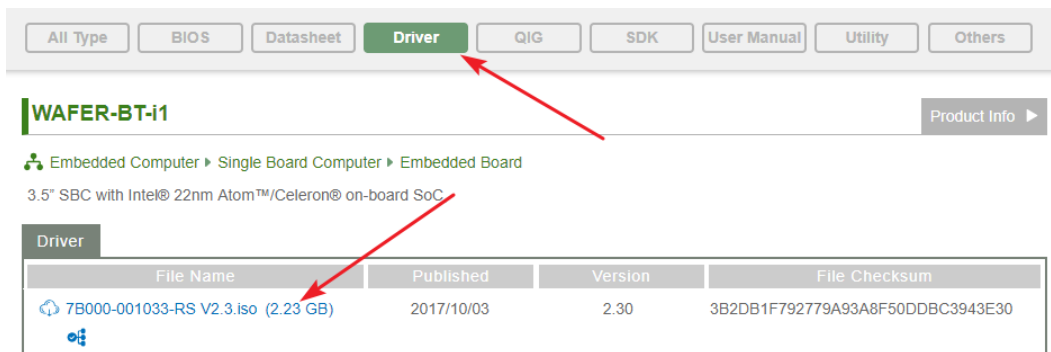

Step 3: Click the driver file name on the page and you will be prompted with the following window. You can download the entire ISO file (❶), or click the small arrow to find an individual driver and click the file name to download (❷).

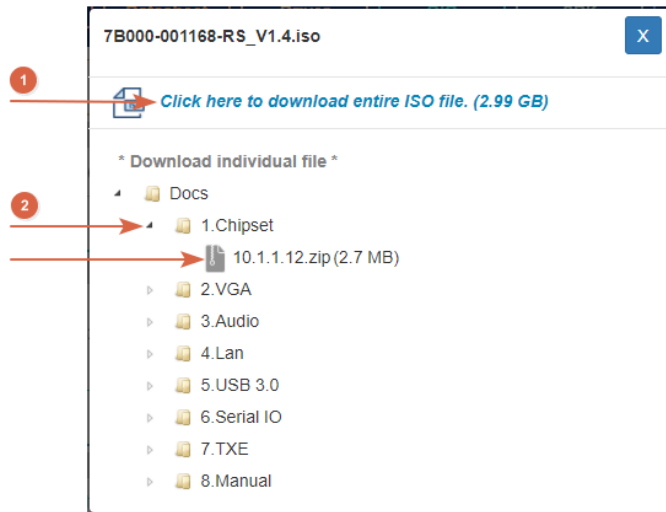

NOTE:

To install software from the downloaded ISO image file in Windows 10, or 11, double-click the ISO file to mount it as a virtual drive to view its content.

3.11.2 Adjust Brightlight

Among the AFL4 series products, AFL4-W10-EHL, AFL4-W12-EHL and AFL4-12-EHL can use the "Adjust Brightlight" software to adjust the brightness. Users can download the software from the IEI official website or contact IEI sales to obtain the software. After the installation, the Adjust Brightlight can be accessed by clicking the  icon on the notification area. It allows users to control screen brightness.

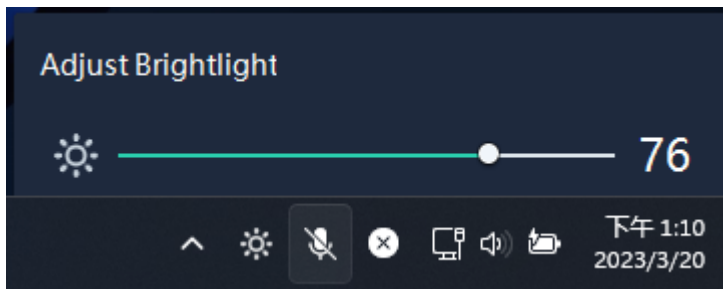

Figure 3-19: Keypad AP

Chapter

4

System Maintenance

4.1 System Maintenance Introduction

If the components of the AFL4-W10/W12/12/W13-EHL fail they must be replaced. Please contact the system reseller or vendor to purchase the replacement parts. Back cover removal instructions for the AFL4-W10/W12/12/W13-EHL are described below.

4.2 Anti-static Precautions



WARNING:

Failure to take ESD precautions during the maintenance of the AFL4-W10/W12/12/W13-EHL may result in permanent damage to the AFL4-W10/W12/12/W13-EHL and severe injury to the user.

Electrostatic discharge (ESD) can cause serious damage to electronic components, including the AFL4-W10/W12/12/W13-EHL. Dry climates are especially susceptible to ESD. It is therefore critical that whenever the AFL4-W10/W12/12/W13-EHL is accessed internally, or any other electrical component is handled, the following anti-static precautions are strictly adhered to.

- **Wear an anti-static wristband:** - Wearing a simple anti-static wristband can help to prevent ESD from damaging the board.
- **Self-grounding:** - Before handling the board touch any grounded conducting material. During the time the board is handled, frequently touch any conducting materials that are connected to the ground.
- **Use an anti-static pad:** - When configuring the AFL4-W10/W12/12/W13-EHL, place it on an anti-static pad. This reduces the possibility of ESD damaging the AFL4-W10/W12/12/W13-EHL.
- **Only handle the edges of the PCB:** - When handling the PCB, hold the PCB by the edges.

AFL4-W10/W12/12/W13-EHL Panel PC

4.3 Turn off the Power



WARNING:

Failing to turn off the system before opening it can cause permanent damage to the system and serious or fatal injury to the user.

Before any maintenance procedures are carried out on the system, make sure the system is turned off.

4.4 WLAN Card Replacement

The AFL4-W10/W12/12/W13-EHL has one WLAN card slot. To replace the WLAN card, follow the instructions below.

- Step 1:** Follow all anti-static procedures.
- Step 2:** Turn off the power.
- Step 3:** Remove the back cover. See **Section 3.4** above.
- Step 4:** Locate the WLAN module (**Figure 4-1**).

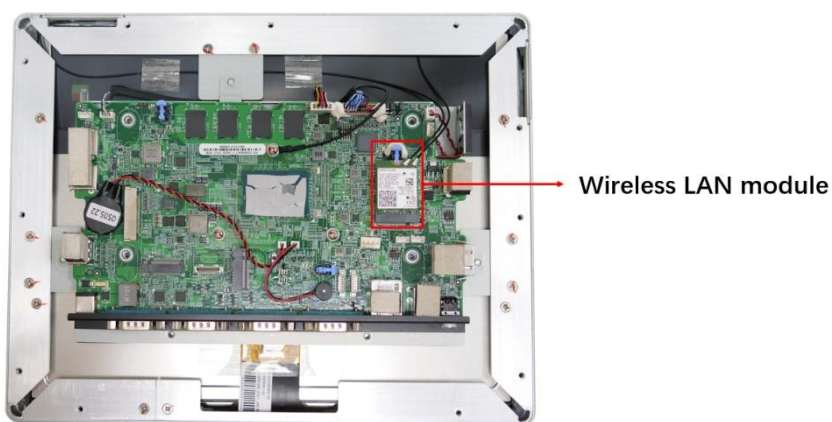

Figure 4-1: WLAN Module Location

Step 5: Disconnect the antenna cables on the WLAN module and remove the retention screw to release the WLAN card (**Figure 4-2**).

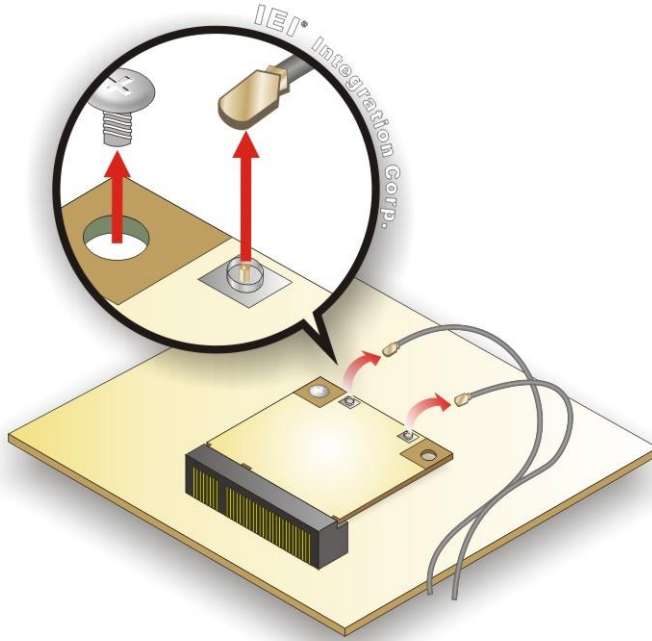

Figure 4-2: Releasing the WLAN Module

Step 6: Grasp the WLAN module by the edges and carefully pull it out of the socket (**Figure 4-3**).

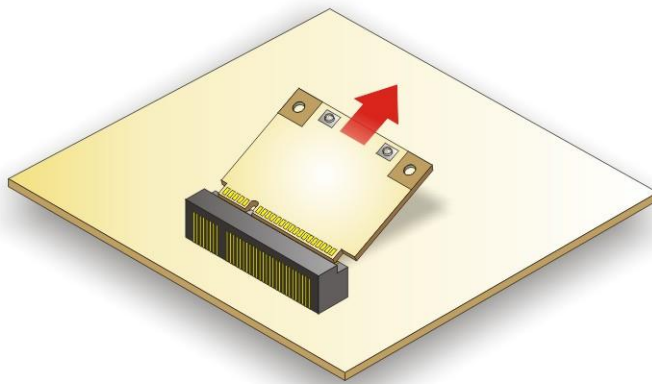

Figure 4-3: Removing the WLAN Module

Step 7: Install a new WLAN module by inserting the module into the slot at an angle.

AFL4-W10/W12/12/W13-EHL Panel PC

Step 8: Push the WLAN module down and secure it with the previously removed retention screw.

Step 9: Connect the antenna cables.

Step 10: Replace the back cover and secure it using the previously removed retention screws.

4.5 Reinstalling the Cover



WARNING:

Failing to reinstall the cover may result in permanent damage to the system. Please make sure all coverings are properly installed.

When maintenance procedures are complete, please make sure the back cover is replaced.

Chapter

5

BIOS

AFL4-W10/W12/12/W13-EHL Panel PC

5.1 Introduction

The BIOS is programmed onto the BIOS chip. The BIOS setup program allows changes to certain system settings. This chapter outlines the options that can be changed.



NOTE:

Some of the BIOS options may vary throughout the life cycle of the product and are subject to change without prior notice.

5.1.1 Starting Setup

The UEFI BIOS is activated when the computer is turned on. The setup program can be activated in one of two ways.

1. **Using keyboard:** Press the **DEL** or **F2** as soon as the system is turned on.
2. **Using touchscreen:** Press the **Setup** button on the upper right corner of the BIOS Starting Menu.

If the message disappears before the **DEL** or **F2** key is pressed, restart the computer and try again, then the BIOS Starting Menu will appear. Select "Setup" and press Enter to get into the BIOS Setup.

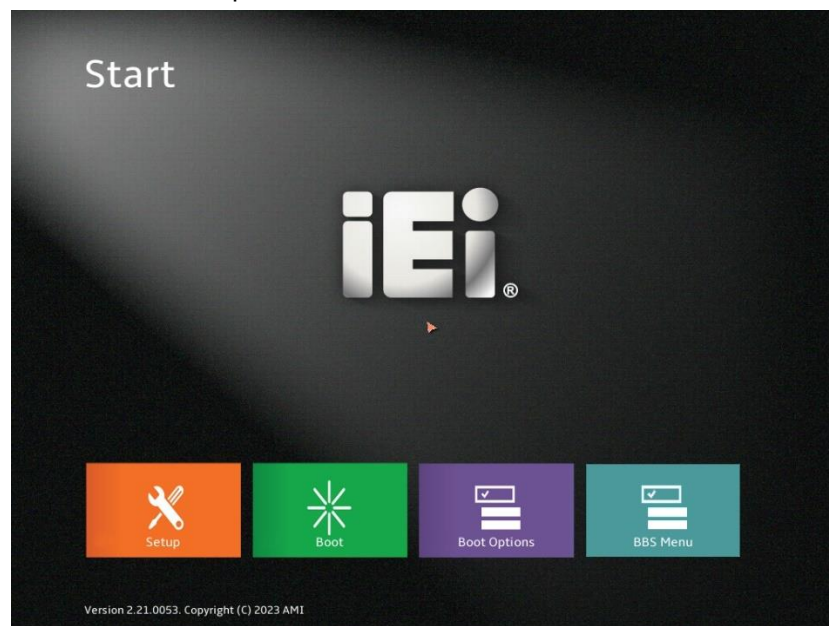

Figure 5-1: BIOS Starting Menu

5.1.2 Using Setup

The BIOS Setup menu can be navigated by using a keyboard or a touchscreen.

5.1.2.1 Keyboard Navigation

For keyboard navigation, use the navigation keys shown in **Table 5-1**.

| Key | Function |
|-------------|--|
| Up arrow | Move to previous item |
| Down arrow | Move to next item |
| Left arrow | Move to the item on the left hand side |
| Right arrow | Move to the item on the right hand side |
| + | Increase the numeric value or make changes |
| - | Decrease the numeric value or make changes |
| Page Up | Move to the previous page |
| Page Dn | Move to the next page |
| Esc | Main Menu – Quit and not save changes into CMOS Status Page Setup Menu and Option Page Setup Menu -- Exit current page and return to Main Menu |
| F1 | General help, only for Status Page Setup Menu and Option Page Setup Menu |
| F2 | Load previous values |
| F3 | Load optimized defaults |
| F4 | Save changes and Exit BIOS |
| <K> | Scroll help area upwards |
| <M> | Scroll help area downwards |

Table 5-1: BIOS Navigation Keys

AFL4-W10/W12/12/W13-EHL Panel PC

5.1.2.2 Touch Navigation

For touchscreen navigation, use the on-screen navigation keys shown below.

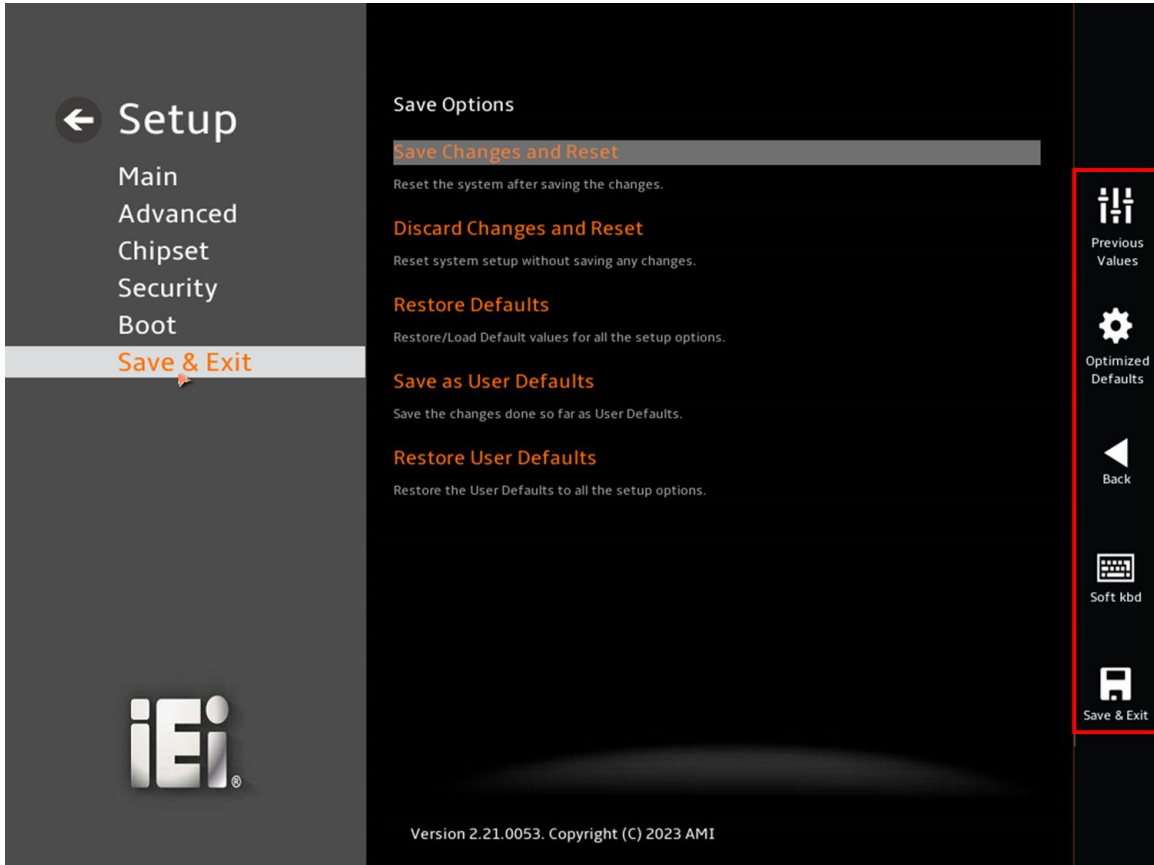

| On-screen Button | Function |
|--------------------|---|
| Previous Values | Load the last value you set. |
| Optimized Defaults | Load the factory default values in order to achieve the best performance. |
| Back | Return to the previous menu. |
| Soft kbd | Display the on-screen keyboard. |
| Save & Exit | Save the changes made to the BIOS options and reset the system. |

Table 5-2: BIOS On-screen Navigation Keys

5.1.3 Getting Help

When **F1** is pressed a small help window describing the appropriate keys to use and the possible selections for the highlighted item appears. To exit the Help Window, press the **Esc** key.

5.1.4 Unable to Reboot after Configuration Changes

If the computer cannot boot after changes to the system configuration is made, CMOS defaults. Use the clear CMOS button described in **Chapter 3**.

5.1.5 BIOS Menu Bar

The **menu bar** on top of the BIOS screen has the following main items:

- Main – Changes the basic system configuration.
- Advanced – Changes the advanced system settings.
- Chipset – Changes the chipset settings.
- Security – Sets User and Supervisor Passwords.
- Boot – Changes the system boot configuration.
- Save & Exit – Selects exit options and loads default settings

The following sections completely describe the configuration options found in the menu items at the top of the BIOS screen and listed above.

AFL4-W10/W12/12/W13-EHL Panel PC

5.2 Main

The **Main** BIOS menu appears when the **BIOS Setup** program is entered. The **Main** menu gives an overview of the basic system information.

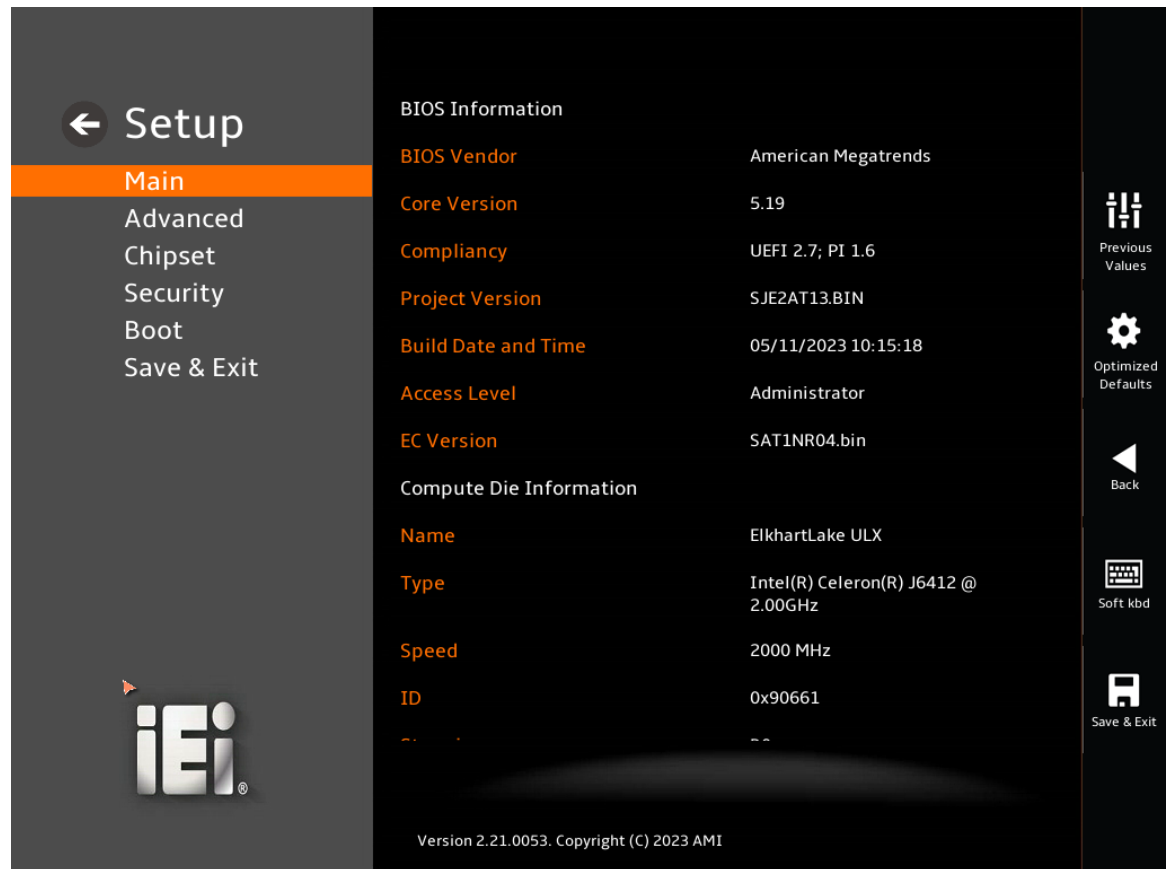

BIOS Menu 1: Main (1/3)



← Setup

- Main
- Advanced
- Chipset
- Security
- Boot
- Save & Exit

iEi

| | |
|----------------------|-----------------------|
| Speed | 2000 MHz |
| ID | 0x90661 |
| Stepping | B0 |
| Number of Processors | 4Core(s) / 4Thread(s) |
| Microcode Revision | 17 |
| Total Memory | 8192 MB |
| Memory Data Rate | 3200 MTPS |
| PCH Information | |
| Name | EHL PCH |
| Stepping | B1 |
| ME FW Version | 15.40.16.2485 |
| ME Firmware SKU | Consumer SKU |
| System Date | 05/22/2023 |

Set the Date. Use Tab to switch between Date elements.
Default Ranges:

Version 2.21.0053. Copyright (C) 2023 AMI

Previous Values

Optimized Defaults

Back

Soft kbd

Save & Exit

BIOS Menu 2: Main (2/3)

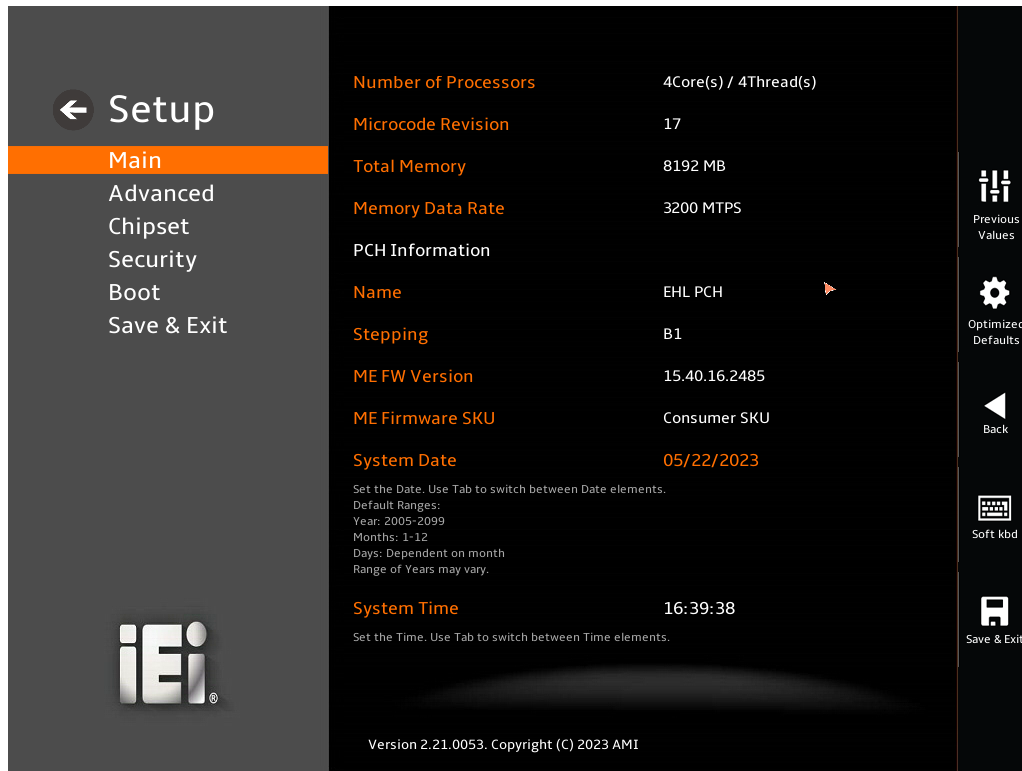

← Setup

- Main
- Advanced
- Chipset
- Security
- Boot
- Save & Exit

iEi

| | |
|----------------------|-----------------------|
| Number of Processors | 4Core(s) / 4Thread(s) |
| Microcode Revision | 17 |
| Total Memory | 8192 MB |
| Memory Data Rate | 3200 MTPS |
| PCH Information | |
| Name | EHL PCH |
| Stepping | B1 |
| ME FW Version | 15.40.16.2485 |
| ME Firmware SKU | Consumer SKU |
| System Date | 05/22/2023 |

Set the Date. Use Tab to switch between Date elements.
Default Ranges:
Year: 2005-2099
Months: 1-12
Days: Dependent on month
Range of Years may vary.

| | |
|-------------|----------|
| System Time | 16:39:38 |
|-------------|----------|

Set the Time. Use Tab to switch between Time elements.

Version 2.21.0053. Copyright (C) 2023 AMI

Previous Values

Optimized Defaults

Back

Soft kbd

Save & Exit

BIOS Menu 3: Main (3/3)

AFL4-W10/W12/12/W13-EHL Panel PC

→ BIOS Information

The **BIOS Information** lists a brief summary of the BIOS. The fields in **BIOS Information** cannot be changed. The items shown in the system overview include:

- **BIOS Vendor:** Installed BIOS vendor
- **Core Version:** Current BIOS version
- **Compliancy:** Current UEFI & PI version
- **Project Version:** the board version
- **Build Date and Time:** Date the current BIOS version was made
- **Access Level:** Administrator
- **EC Version:** Current EC version

→ Compute Die Information

The **Compute Die Information** lists a brief summary of the Processor. The fields in **Processor Information** cannot be changed. The items shown in the system overview include:

- Name:** Displays the Processor Details
- Type:** Displays the Processor Type
- Speed:** Displays the Processor Speed
- ID:** Displays the Processor ID
- Stepping:** Displays the Processor Stepping
- Number of Processors:** Displays number of CPU cores
- Microcode Revision:** CPU Microcode Revision
- IGFX GOP Version:** Displays the IGFX GOP Version
- Total Memory:** Total Memory in the System
- Memory Data Rate:** Displays the Rate of Memory Data

→ PCH Information

The **PCH Information** lists a brief summary of the PCH. The fields in **PCH Information** cannot be changed. The items shown in the system overview include:

- **Name:** Displays the PCH Name
- **Stepping:** Displays the PCH Stepping
- **ME FW Version:** Displays the ME Firmware Version

- **ME Firmware SKU:** Displays the ME Firmware SKU
- **System Date [xx/xx/xx]:** Use the **System Date** option to set the system date. Manually enter the day, month and year.
- **System Time [xx:xx:xx]:** Use the **System Time** option to set the system time. Manually enter the hours, minutes and seconds.

AFL4-W10/W12/12/W13-EHL Panel PC

5.3 Advanced

Use the **Advanced** menu to configure the CPU and peripheral devices through the following sub-menus:

**WARNING!**

Setting the wrong values in the sections below may cause the system to malfunction. Make sure that the settings made are compatible with the hardware.

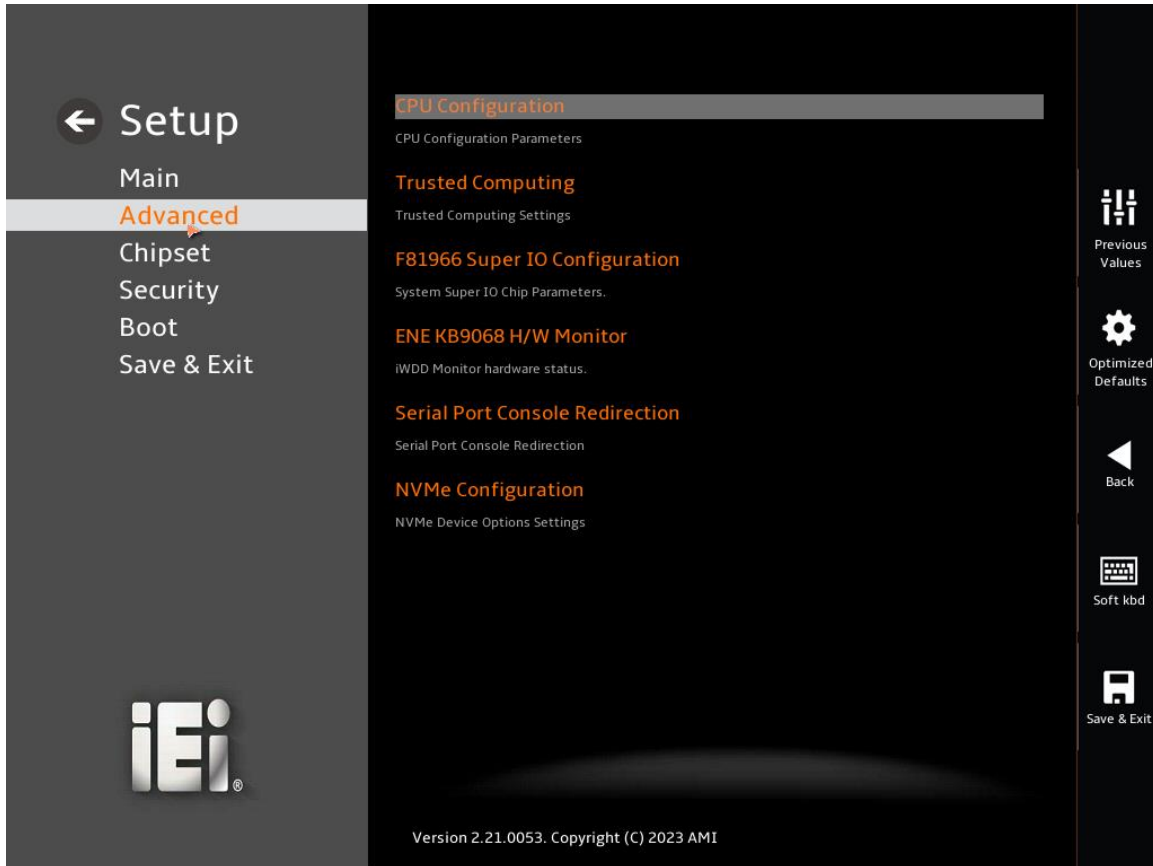

BIOS Menu 4: Advanced

5.3.1 CPU Configuration

Use the **CPU Configuration** menu to view detailed CPU specifications or enable the Intel Virtualization Technology.



BIOS Menu 5: CPU Configuration (1/3)



AFL4-W10/W12/12/W13-EHL Panel PC

BIOS Menu 5: CPU Configuration (2/3)



BIOS Menu 6: CPU Configuration (3/3)

→ Intel (VMX) Virtualization Technology [Enabled]

Use the **Intel (VMX) Virtualization Technology** option to enable or disable virtualization on the system. When combined with third party software, Intel® Virtualization technology allows several OSs to run on the same system at the same time.

- **Disabled** Disables Intel Virtualization Technology.
- **Enabled** **DEFAULT** Enables Intel Virtualization Technology.

→ Active Processor Cores [All]

Use the **Active Processor Cores** BIOS option to enable numbers of cores in the processor package.

- **All** **DEFAULT** Enable all cores in the processor package.
- **1** Enable one core in the processor package.
- **2** Enable two cores in the processor package.

→ **3** Enable three cores in the processor package.

→ **EIST [Enable]**

Use the **EIST** option to enable more than two frequency ranges to be supported.

→ **Disabled** Disables more than two frequency ranges

→ **Enabled** **DEFAULT** Enables more than two frequency ranges

→ **C states [Disabled]**

Use the **C states** option to enable or disable the CPU Power Management.

→ **Disabled** **DEFAULT** Disables CPU to go to C states when it's not 100% utilized.

→ **Enabled** Enables CPU to go to C states when it's not 100% utilized.

→ **Tcc Activation Offset [Enabled]**

Use the **Tcc Activation** option to set Tcc activation temperature at which the Thermal Control Circuit must be activated. Tcc will be activated at: Tcc Activation Temp-Tcc Activation Offset. Tcc Activation Offset range is 0 to 63.

→ **Power Limit 1**

Use the **Power Limit 1** to set Power Limit in Milli Watts. BIOS will round to the nearest 1/8W when programming. 0 = no custom override. For 12.50W, enter 12500. Overclocking SKU: Value must be between Max and Min Power Limits. Other SKUs: This value must be between Min Power limit and TDP Limit. If value is 0, BIOS will program TDP value.

→ **Power Limit 1 Time Window**

Power Limit 1 Time Window value in second. The value may vary from 0 to 128.0, 0 = default value (28 sec for mobile and 8 sec for desktop). Defines time window which TDP value should be maintained.

AFL4-W10/W12/12/W13-EHL Panel PC

→ Power Limit 2

Use the **Power Limit 2** to set Power Limit in Milli Watts. BIOS will round to the nearest 1/8W when programming. If the value is 0, BIOS will program this value as 1.25*TDP. For 12.50W, enter 12500. Processor applies control policies such that the package power does not exceed this limit.

→ Turbo Mode [Enabled]

Use the **Turbo Mode** option to enable or disable Turbo Mode which requires Intel Speed Step or Intel Speed Shift to be available and enabled.

- | | | | |
|---|-----------------|----------------|--------------------------------|
| → | Disabled | | Disables Turbo Mode Technology |
| → | Enabled | DEFAULT | Enables Turbo Mode Technology |

5.3.2 Trusted Computing

Use the **Trusted Computing** menu (**BIOS Menu 7**) to configure settings related to the Trusted Computing Group (TCG) Trusted Platform Module (TPM).

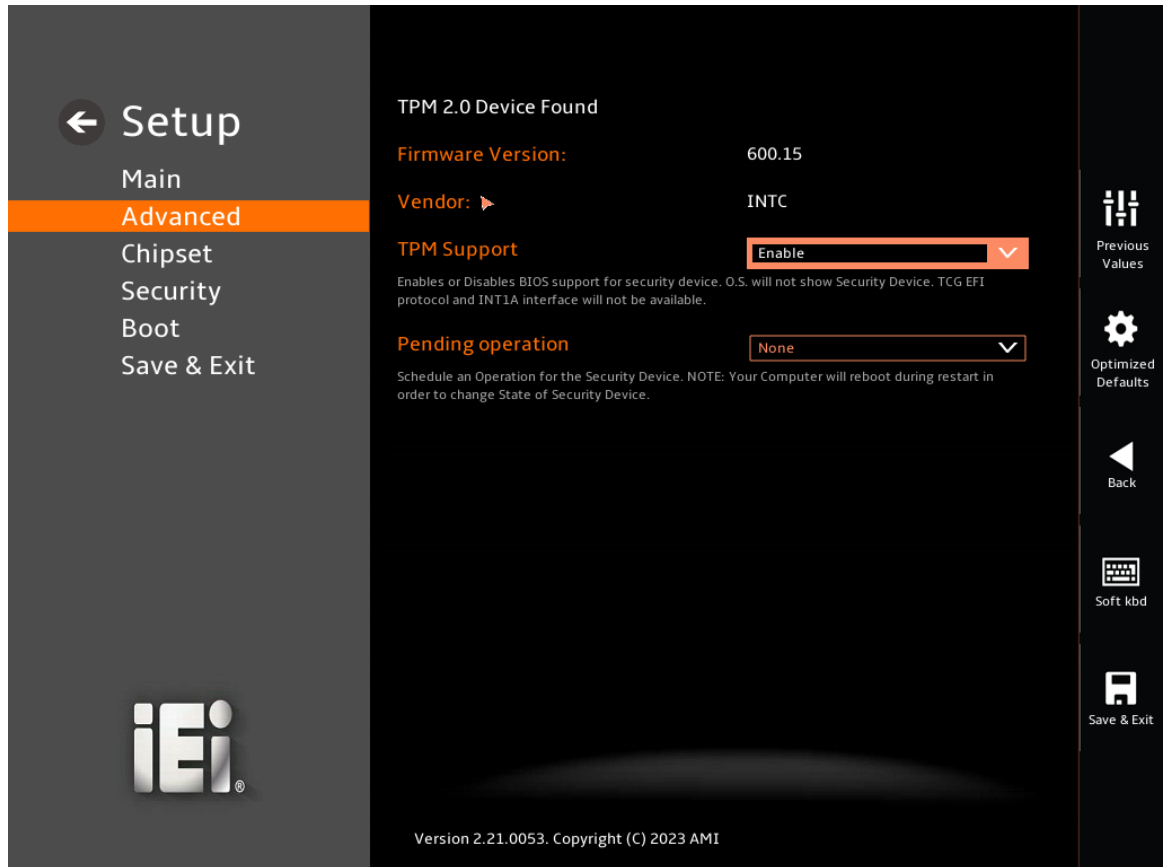

BIOS Menu 7: PCH-FW Configuration

➔ **TPM Support [Enable]**

Use the **TPM Support** option to enable or disable BIOS support for security device.

➔ **Disable** TPM support is disabled.

➔ **Enable** **DEFAULT** TPM support is enabled.

➔ **Pending Operation [None]**

Use the **Pending Operation** option to schedule an operation for the security device.

AFL4-W10/W12/12/W13-EHL Panel PC

- ➔ None **DEFAULT** TPM information is previous.S
- ➔ TPM Clear TPM information is cleared

5.3.3 F81966 Super IO Configuration

Use the **F81966 Super IO Configuration** menu (**BIOS Menu 8**) to set or change the configurations for serial ports.

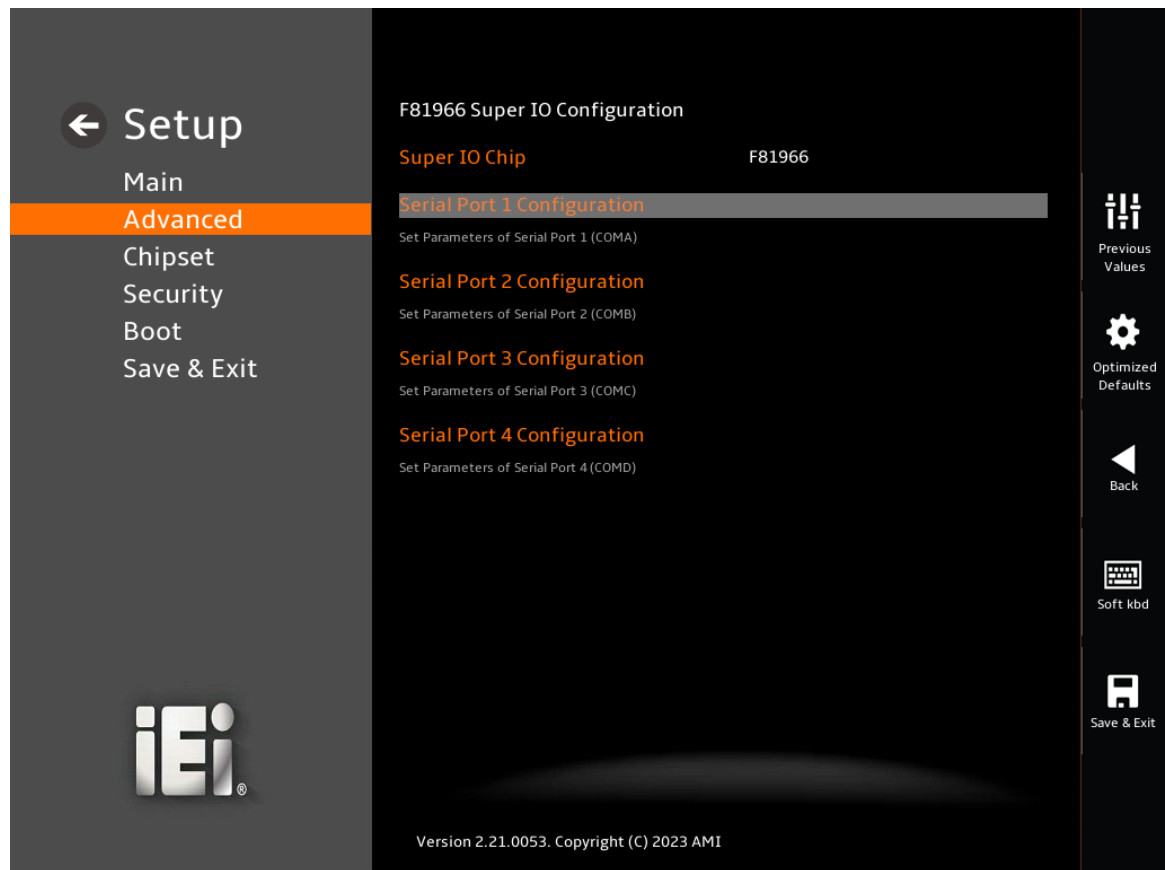

BIOS Menu 8: F81966 Super IO Configuration

5.3.3.1 Serial Port 1 Configuration

Use the **Serial Port 1 Configuration** menu (**BIOS Menu 9**) to configure the serial port.

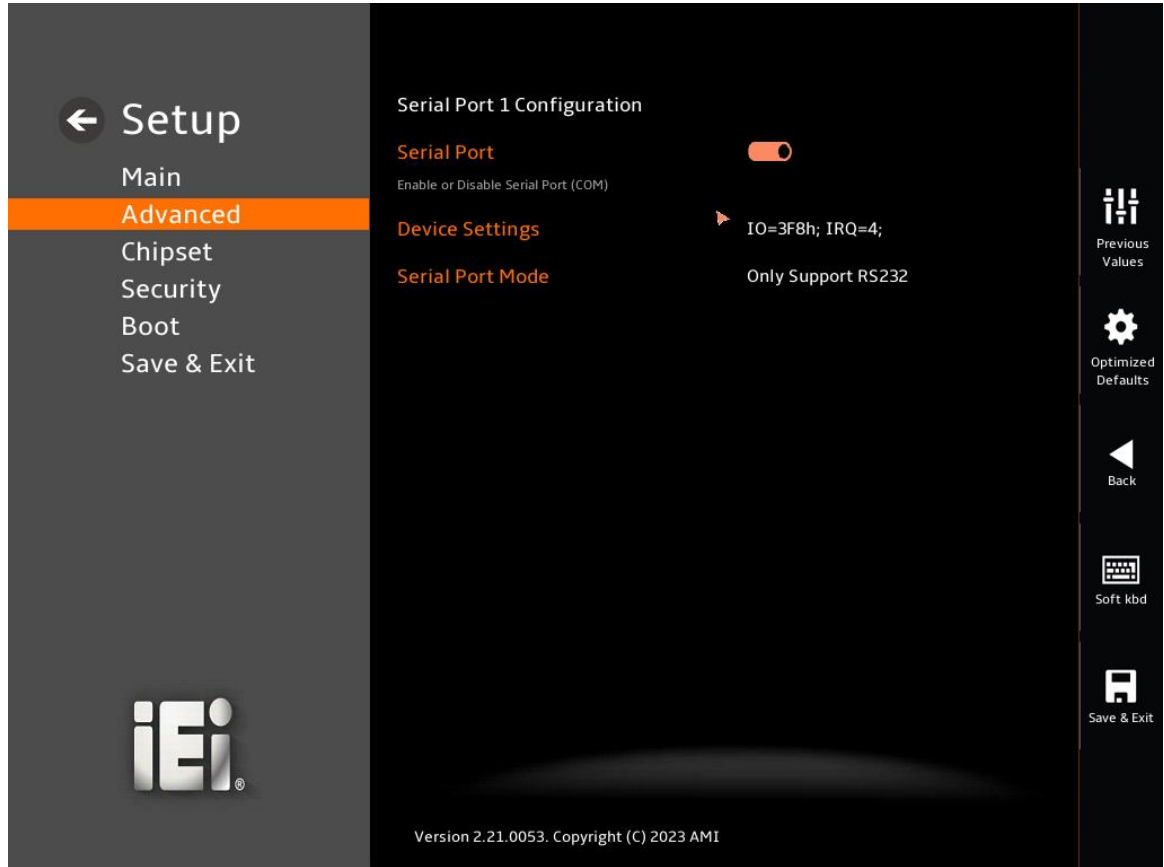

BIOS Menu 9: Serial Port 1 Configuration Menu

➔ Serial Port [Enabled]

Use the **Serial Port** option to enable or disable the serial port.

- ➔ **Disabled** Disable the serial port
- ➔ **Enabled** **DEFAULT** Enable the serial port

➔ Device Settings

The **Device Settings** option shows the serial port IO port address and interrupt address.

AFL4-W10/W12/12/W13-EHL Panel PC

→ **IO=3F8h;** Serial Port I/O port address is 3F8h and the interrupt
IRQ=4 address is IRQ4

→ **Device Mode [RS232]**

Use the **Device Mode** option to change the serial port mode.

| | | |
|----------------------------|----------------|--------------------------------|
| → RS232 | DEFAULT | The serial port mode is RS-232 |
| RS422 with Register | | The serial port mode is RS-422 |
| RS485 with Register | | The serial port mode is RS-485 |

5.3.3.2 Serial Port 2 Configuration

Use the **Serial Port 2 Configuration** menu (**BIOS Menu 10**) to configure the serial port.

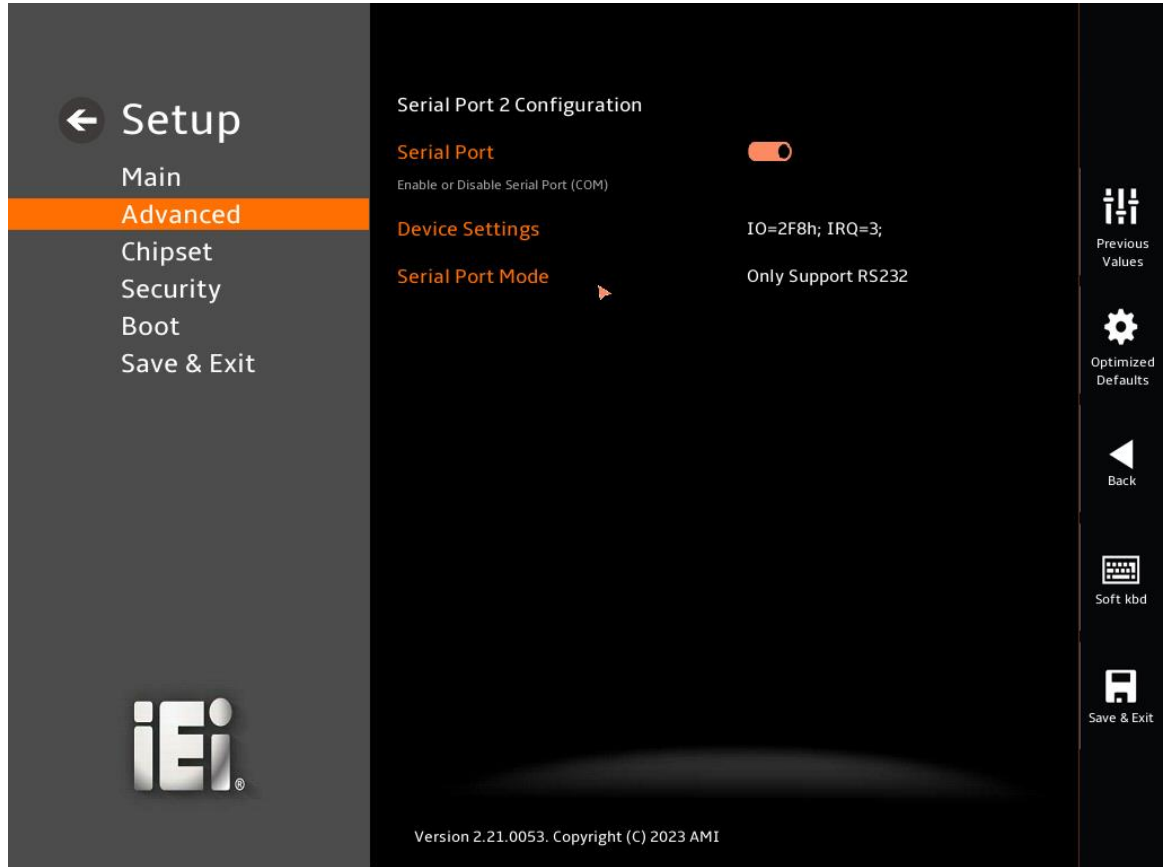

BIOS Menu 10: Serial Port 2 Configuration Menu

➔ Serial Port [Enabled]

Use the **Serial Port** option to enable or disable the serial port.

- ➔ **Disabled** Disable the serial port
- ➔ **Enabled** **DEFAULT** Enable the serial port

➔ Device Settings

The **Device Settings** option shows the serial port IO port address and interrupt address.

AFL4-W10/W12/12/W13-EHL Panel PC

→ **IO=2F8h;** Serial Port I/O port address is 2F8h and the interrupt
IRQ=3 address is IRQ3

→ **Device Mode [RS232]**

Use the **Device Mode** option to change the serial port mode.

| | | |
|----------------------------|----------------|--------------------------------|
| → RS232 | DEFAULT | The serial port mode is RS-232 |
| RS422 with Register | | The serial port mode is RS-422 |
| RS485 with Register | | The serial port mode is RS-485 |

5.3.3.3 Serial Port 3 Configuration

Use the **Serial Port 3 Configuration** menu (**BIOS Menu 11**) to configure the serial port.

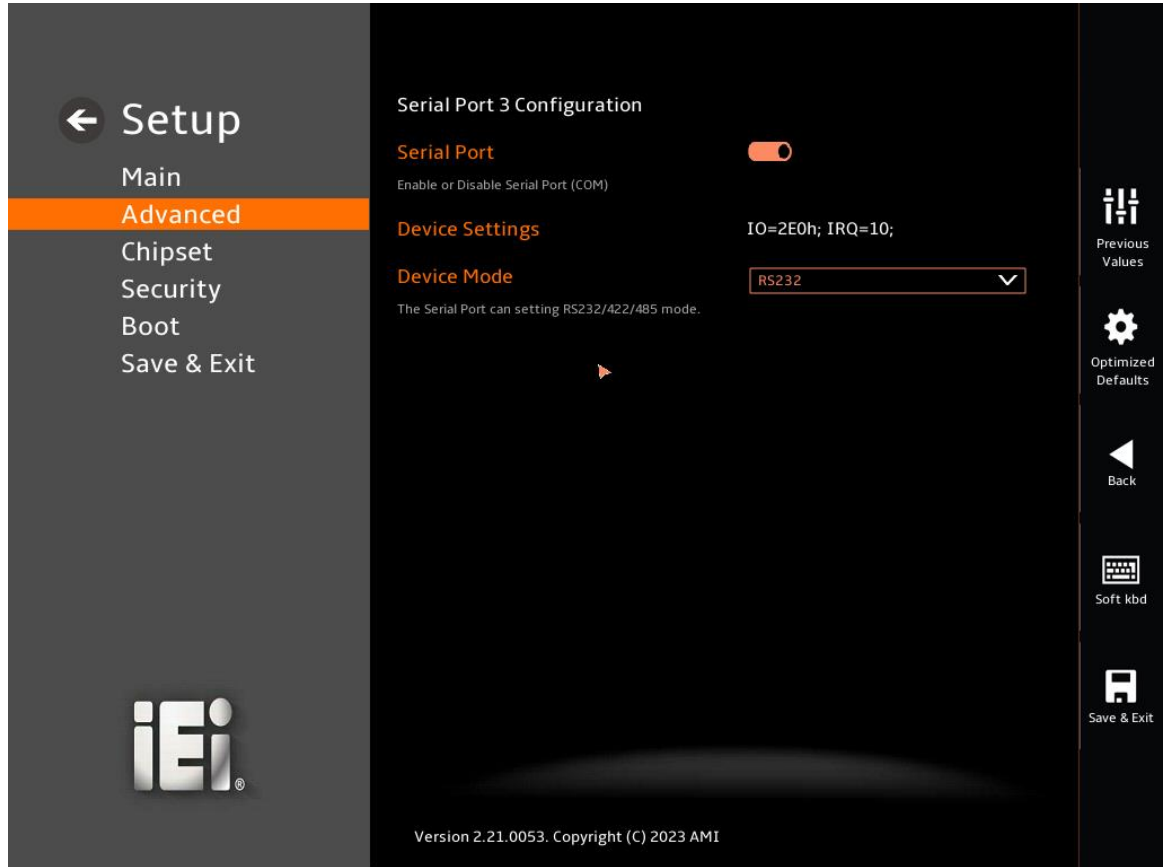

BIOS Menu 11: Serial Port 3 Configuration Menu

➔ Serial Port [Enabled]

Use the **Serial Port** option to enable or disable the serial port.

- ➔ **Disabled** Disable the serial port
- ➔ **Enabled** **DEFAULT** Enable the serial port

➔ Device Settings

The **Device Settings** option shows the serial port IO port address and interrupt address.

AFL4-W10/W12/12/W13-EHL Panel PC

- ➔ **IO=2E0h;** Serial Port I/O port address is 2E0h and the interrupt
IRQ=10 address is IRQ10

5.3.3.4 Serial Port 4 Configuration

Use the **Serial Port 4 Configuration** menu (**BIOS Menu 12**) to configure the serial port.

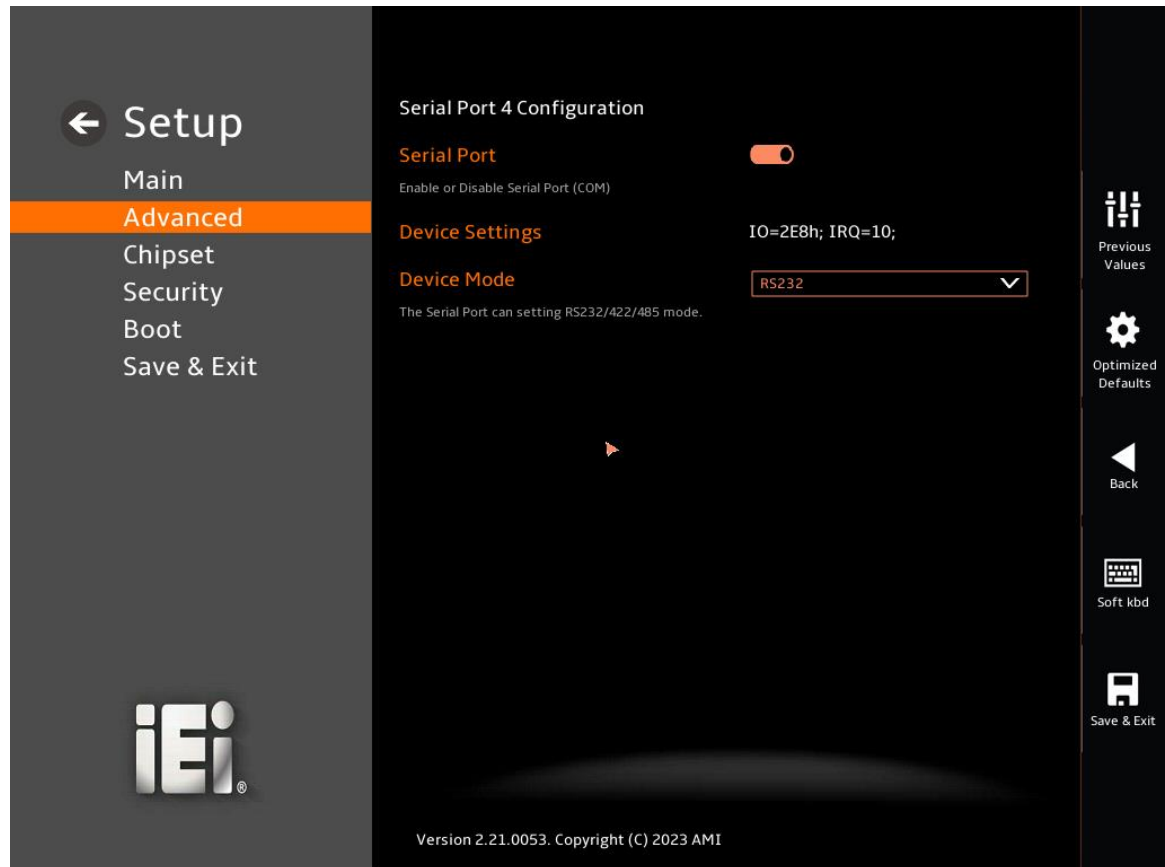

BIOS Menu 12: Serial Port 4 Configuration Menu

- ➔ **Serial Port [Enabled]**

Use the **Serial Port** option to enable or disable the serial port.

- ➔ **Disabled** Disable the serial port
- ➔ **Enabled** **DEFAULT** Enable the serial port

➔ **Device Settings**

The **Device Settings** option shows the serial port IO port address and interrupt address.

➔ **IO=2E8h;** Serial Port I/O port address is 2E8h and the interrupt
IRQ=10 address is IRQ10

5.3.4 EC KB9068 H/W Monitor

The **EC KB9068 H/W Monitor** menu (**BIOS Menu 13**) contains the smart fan mode configuration submenu and shows the state of H/W real-time operating temperature, fan speeds and system voltages.



BIOS Menu 13: EC KB9068 H/W Monitor

AFL4-W10/W12/12/W13-EHL Panel PC

→ PC Health Status

The following system parameters and values are shown. The system parameters that are monitored are:

- System Temperatures:
 - CPU Temperature
 - System Temperature1
 - Fan Speeds:
 - CPU_Fan1 Speed
 - SYS_Fan1 Speed
 - Voltages:
 - CPU_CORE1
 - +12V
 - DDR
 - +5VSB
 - +3.3VSB
 - +VCCIN_AUX_CPU

5.3.4.1 Smart Fan Mode Configuration

Use the **Smart Fan Mode Configuration** submenu (**BIOS Menu 14**) to configure the CPU/system fan start/off temperature and control mode.

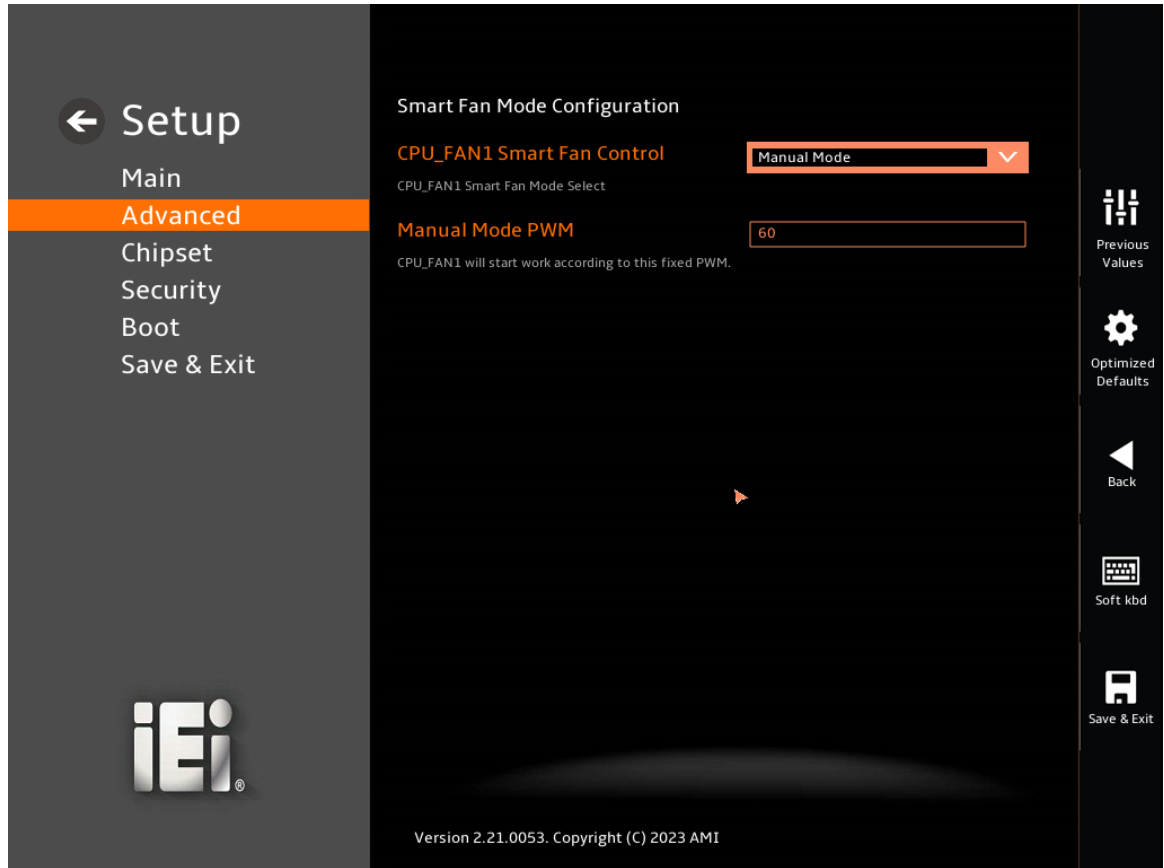

BIOS Menu 14: Smart Fan Mode Configuration

→ CPU_FAN1 Smart Fan Control [Auto Mode]

Use the **CPU_FAN1 Smart Fan Control** option to configure the CPU Smart Fan.

- **Manual Mode** The fan spins at the speed set in Manual Mode settings.
- **Auto Mode** **DEFAULT** The fan adjusts its speed using Auto Mode settings.

AFL4-W10/W12/12/W13-EHL Panel PC

→ CPU_FAN1 Start Temperature

If the CPU temperature is between **fan off** and **fan start**, the fan speed change to **fan start PWM**. To set a value, Use the + or – key to change the value or enter a decimal number between 1 and 100.

→ CPU_FAN1 Off Temperature

If the CPU temperature is lower than the value set this option, the fan speed change to be lowest. To set a value, Use the + or – key to change the value or enter a decimal number between 1 and 100.

→ CPU_FAN1 Start PWM

Use the **CPU_FAN1 Start PWM** option to set the PWM start value. Use the + or – key to change the value or enter a decimal number between 1 and 100.

→ SYS_FAN1 Smart Fan Control [Auto Mode]

Use the **SYS_FAN1 Smart Fan Control** option to configure the System Smart Fan.

- **Manual Mode** The fan spins at the speed set in Manual Mode settings.
- **Auto Mode** **DEFAULT** The fan adjusts its speed using Auto Mode settings.

→ SYS_FAN1 Start Temperature

If the System temperature is between **fan off** and **fan start**, the fan speed change to **fan start PWM**. To set a value, Use the + or – key to change the value or enter a decimal number between 1 and 100.

→ SYS_FAN1 Off Temperature

If the System temperature is lower than the value set this option, the fan speed change to be lowest. To set a value, Use the + or – key to change the value or enter a decimal number between 1 and 100.

➔ **SYS_FAN1 Start PWM**

Use the **SYS_Fan1 Start PWM** option to set the PWM start value. Use the + or – key to change the value or enter a decimal number between 1 and 100.

5.3.5 Serial Port Console Redirection

The **Serial Port Console Redirection** menu (**BIOS Menu 15**) allows the console redirection options to be configured. Console Redirection allows users to maintain a system remotely by re-directing keyboard input and text output through the serial port.

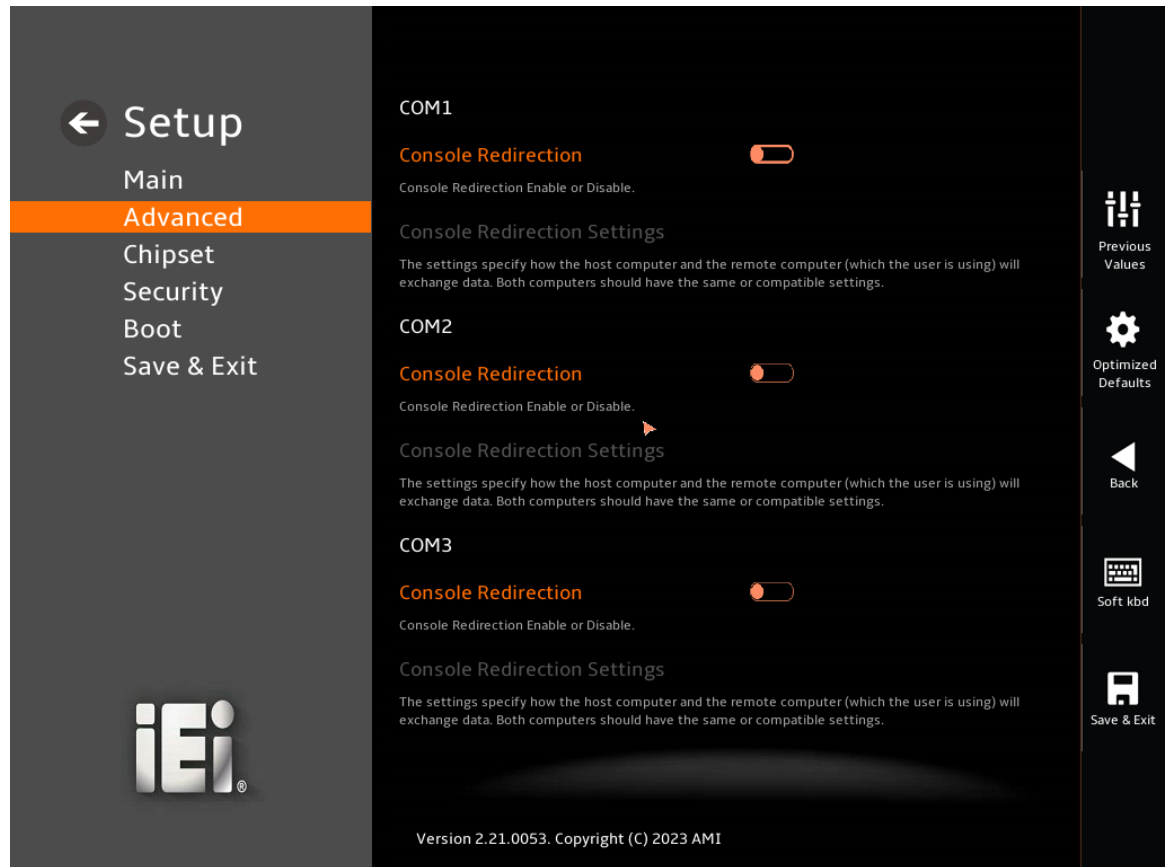

BIOS Menu 15: Serial Port Console Redirection (1/2)

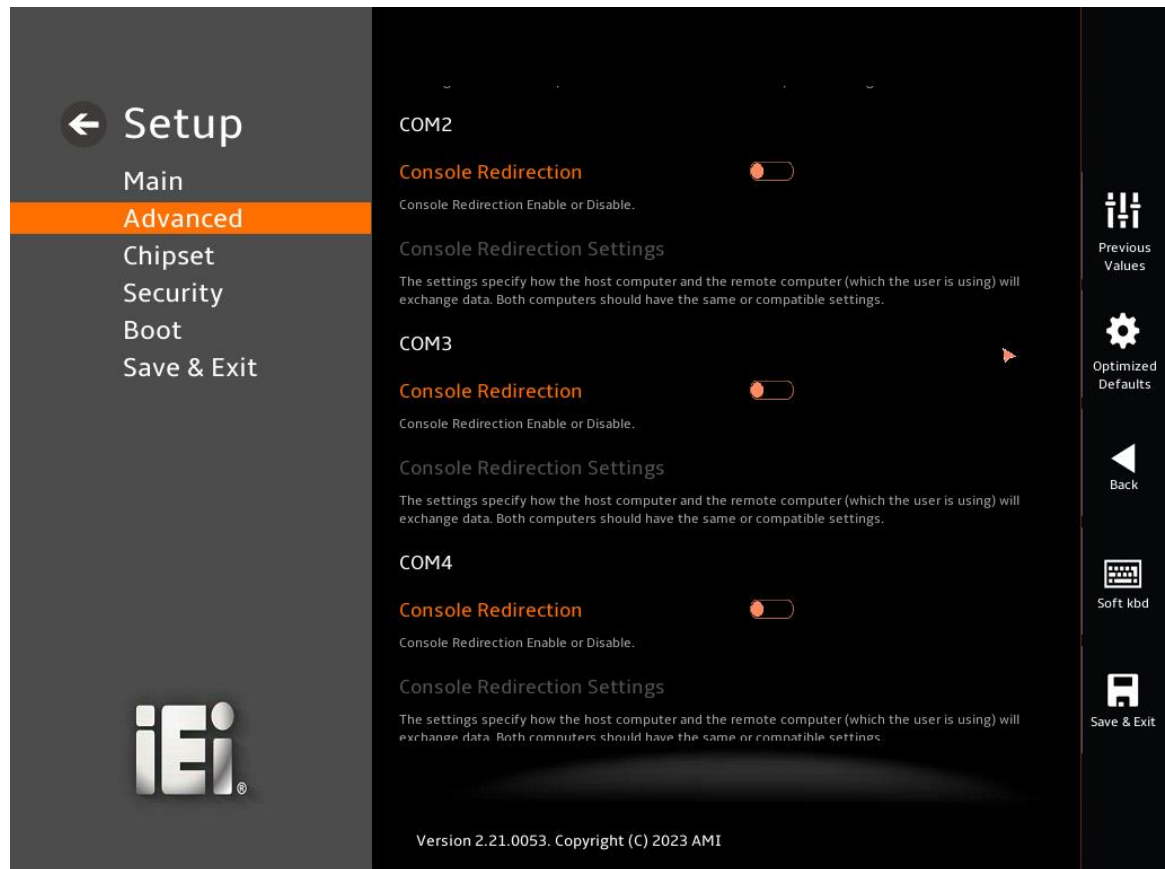

BIOS Menu 16: Serial Port Console Redirection (2/2)

→ Console Redirection [Disabled]

Use **Console Redirection** option to enable or disable the console redirection function.

- **Disabled** **DEFAULT** Disabled the console redirection function
- **Enabled** Enabled the console redirection function

The **Console Redirection Settings** submenu will be available when the **Console Redirection** option is enabled.

5.3.5.1 Console Redirection Settings

The following options are available in the **Console Redirection Settings** submenu (**BIOS Menu 17**) when the **COM Console Redirection** (for COM1 to COM6) option is enabled.

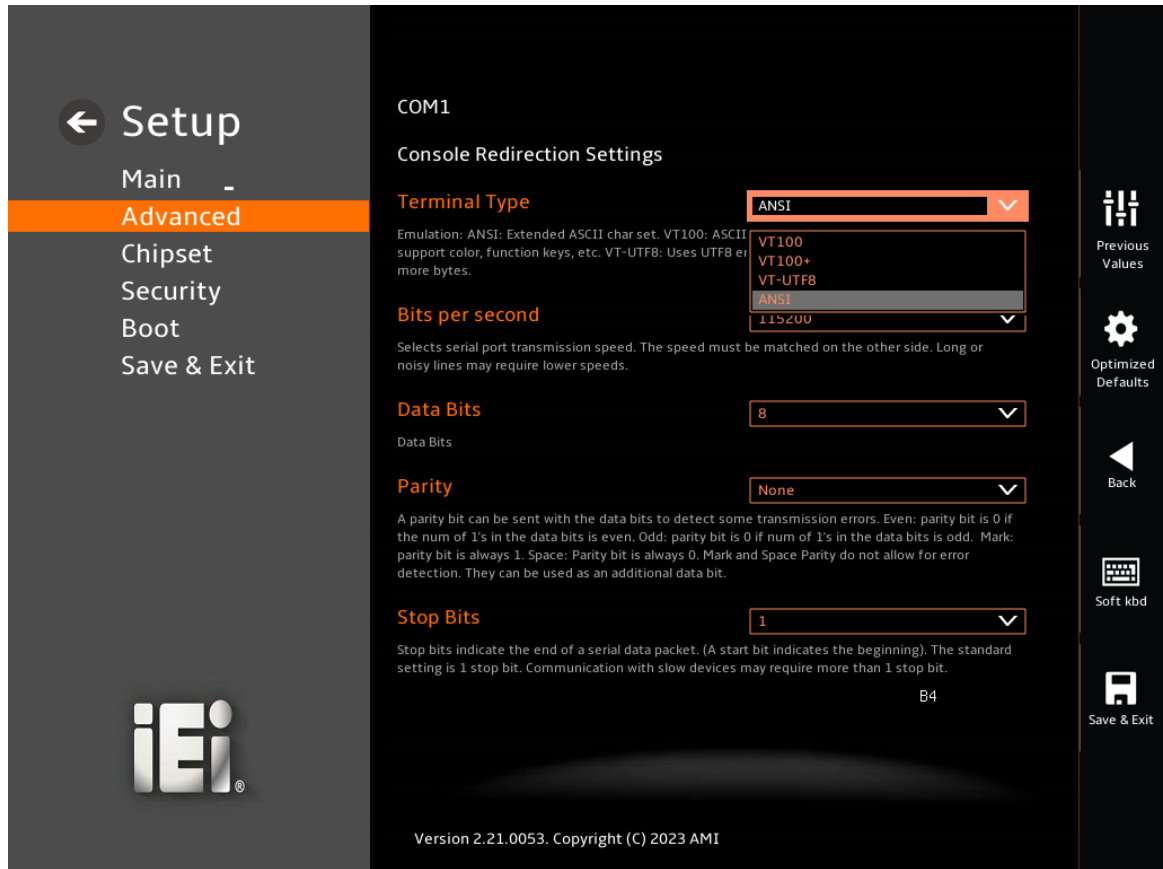

BIOS Menu 17: COM Console Redirection Settings

➔ **Terminal Type [ANSI]**

Use the **Terminal Type** option to specify the remote terminal type.

- ➔ **VT100** The target terminal type is VT100
- ➔ **VT100+** The target terminal type is VT100+
- ➔ **VT-UTF8** The target terminal type is VT-UTF8
- ➔ **ANSI** **DEFAULT** The target terminal type is ANSI

➔ **Bits per second [115200]**

Use the **Bits per second** option to specify the serial port transmission speed. The speed must match on the other side. Long or noisy lines may require lower speeds.

AFL4-W10/W12/12/W13-EHL Panel PC

- **9600** Sets the serial port transmission speed at 9600.
- **19200** Sets the serial port transmission speed at 19200.
- **38400** Sets the serial port transmission speed at 38400.
- **57600** Sets the serial port transmission speed at 57600.
- **115200** **DEFAULT** Sets the serial port transmission speed at 115200.

→ **Data Bits [8]**

Use the **Data Bits** option to specify the number of data bits.

- **7** Sets the data bits at 7.
- **8** **DEFAULT** Sets the data bits at 8.

→ **Parity [None]**

Use the **Parity** option to specify the parity bit that can be sent with the data bits for detecting the transmission errors.

- **None** **DEFAULT** No parity bit is sent with the data bits.
- **Even** The parity bit is 0 if the number of ones in the data bits is even.
- **Odd** The parity bit is 0 if the number of ones in the data bits is odd.
- **Mark** The parity bit is always 1. This option does not allow for error detection.
- **Space** The parity bit is always 0. This option does not allow for error detection.

→ **Stop Bits [1]**

Use the **Stop Bits** option to specify the number of stop bits used to indicate the end of a serial data packet. Communication with slow devices may require more than 1 stop bit.

- **1** **DEFAULT** Sets the number of stop bits at 1.

→ 2

Sets the number of stop bits at 2.

5.3.6 NVMe Configuration

Use the **NVMe Configuration (BIOS Menu 18)** menu to display the NVMe controller and device information.

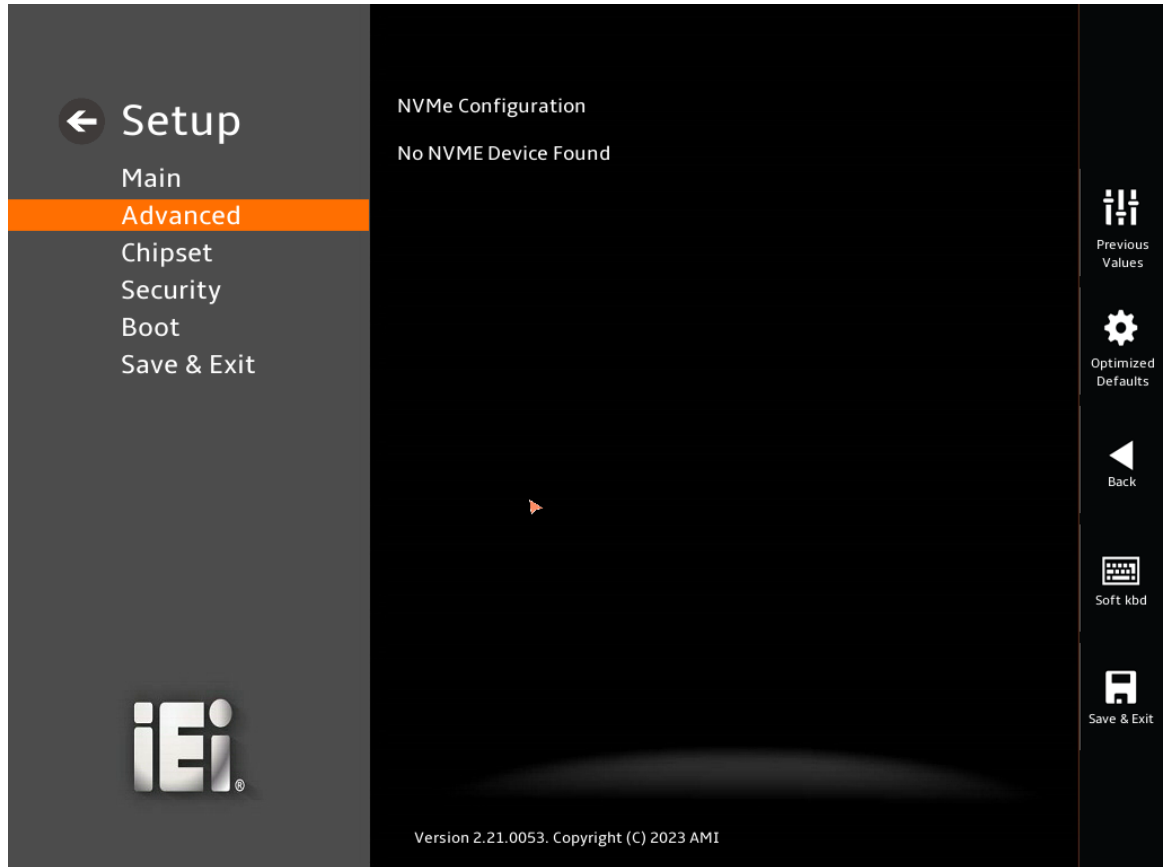

BIOS Menu 18: NVMe Configuration

5.4 Chipset

Use the **Chipset** menu (**BIOS Menu 19**) to access the PCH IO and System Agent (SA) configuration menus.



WARNING!

Setting the wrong values for the Chipset BIOS selections in the Chipset BIOS menu may cause the system to malfunction.



BIOS Menu 19: Chipset

5.4.1 System Agent (SA) Configuration

Use the **System Agent (SA) Configuration** menu (**BIOS Menu 20**) to configure the System Agent (SA) parameters.

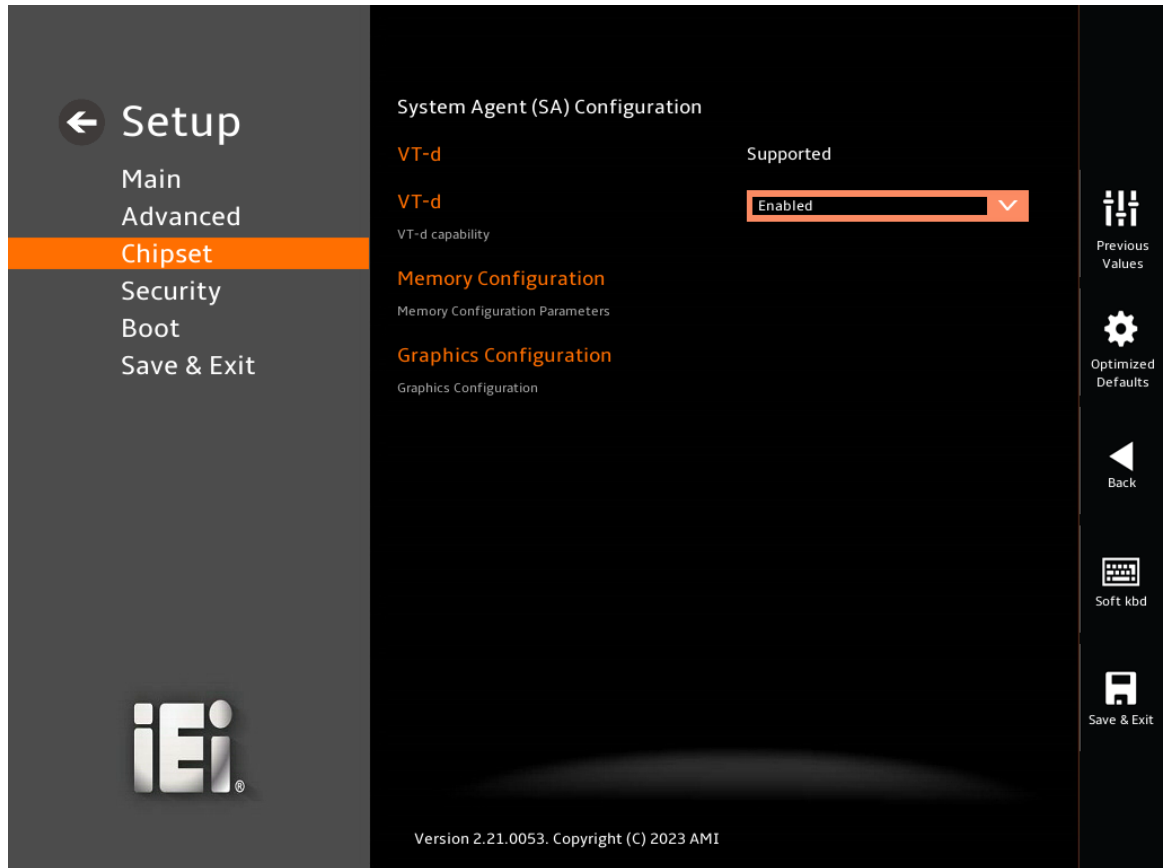

BIOS Menu 20: System Agent (SA) Configuration

➔ **VT-d [Enabled]**

Use the **VT-d** option to enable or disable the VT-d capability.

- ➔ **Disabled** Disable the VT-d capability
- ➔ **Enabled** **DEFAULT** Enable the VT-d capability

5.4.1.1 Memory Configuration

Use the **Memory Configuration** submenu (**BIOS Menu 21**) to view memory information.



BIOS Menu 21: Memory Configuration

5.4.1.2 Graphics Configuration

Use the **Graphics Configuration** (**BIOS Menu 22**) menu to configure the video device connected to the system.

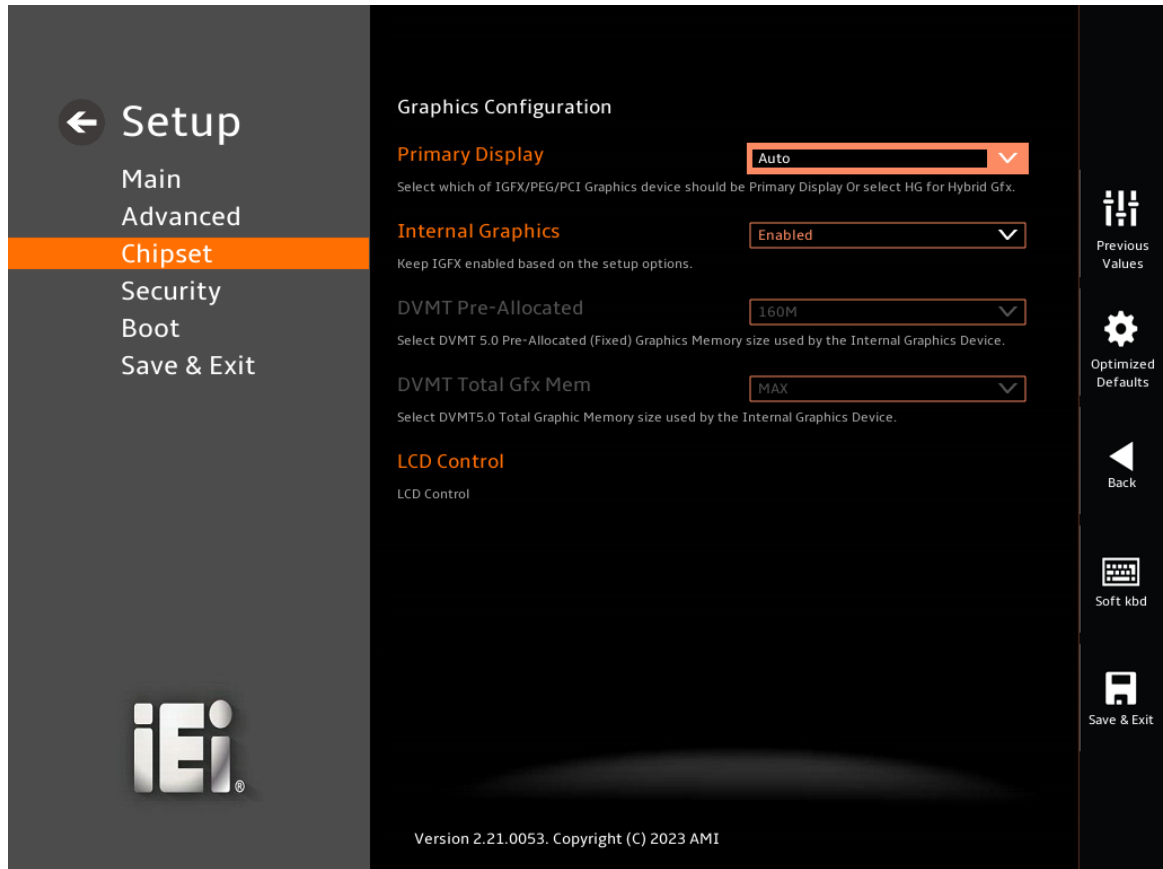

BIOS Menu 22: Graphics Configuration

➔ **Primary Display [Auto]**

Use the **Primary Display** option to select the primary graphics controller the system uses.

The following options are available:

- Auto **Default**
- IGFX
- PEG
- PCI
- SG

➔ **Internal Graphics [Enabled]**

Use the **Internal Graphics** option to configure whether to keep IGFX enabled. If user wants to support dual display by internal graphics and external graphics, this Internal

AFL4-W10/W12/12/W13-EHL Panel PC

Graphics option should be set to Enabled and the above Primary Display option should be set to IGFX.

- **Auto** Auto mode
- **Disabled** Disables IGFX.
- **Enabled** **Default** Enables IGFX.

→ **DVMT Pre-Allocated [160M]**

Use the **DVMT Pre-Allocated** option to set the amount of system memory allocated to the integrated graphics processor when the system boots. The system memory allocated can then only be used as graphics memory, and is no longer available to applications or the operating system. Configuration options are listed below:

- 80M
- 160M **Default**

→ **DVMT Total Gfx Mem [MAX]**

Use the **DVMT Total Gfx Mem** option to select DVMT5.0 total graphic memory size used by the internal graphic device. The following options are available:

- 128M
- 256M
- MAX **Default**

➔ **LCD Control**

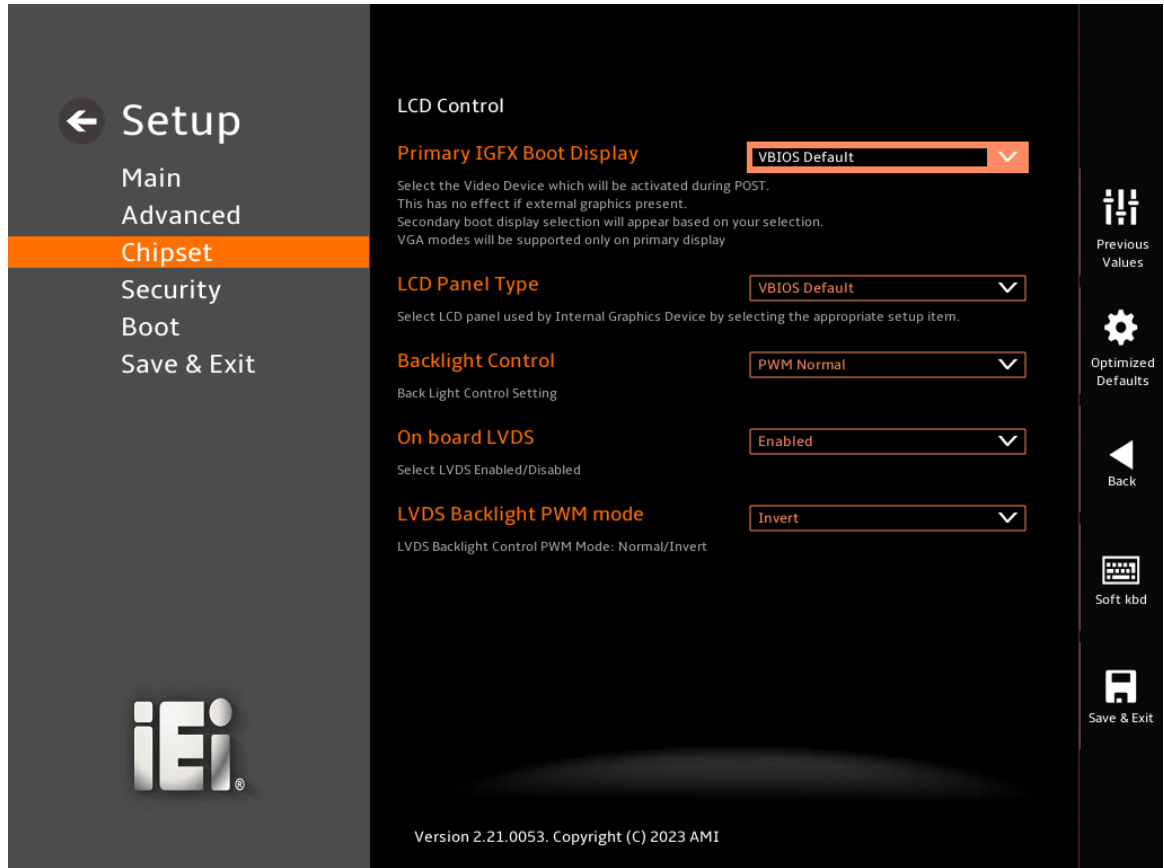

BIOS Menu 23: LCD Control

➔ **On board LVDS [Enabled]**

Use the **On board LVDS** option to select LVDS Enabled or Disabled.

- ➔ **Enabled** **DEFAULT** Enabled on board LVDS.
- ➔ **Disabled** Disabled on board LVDS.

➔ **LVDS Backlight PWM mode[Invert]**

Use the **LVDS Backlight PWM Mode** option to specify a PWM mode for LVDS backlight control.

- ➔ **Invert** **DEFAULT** Set to invert LVDS Backlight.
- ➔ **Normal** Set to normal LVDS Backlight.

AFL4-W10/W12/12/W13-EHL Panel PC

5.4.2 PCH-IO Configuration

Use the **PCH-IO Configuration** menu (**BIOS Menu 24**) to configure the PCH parameters.

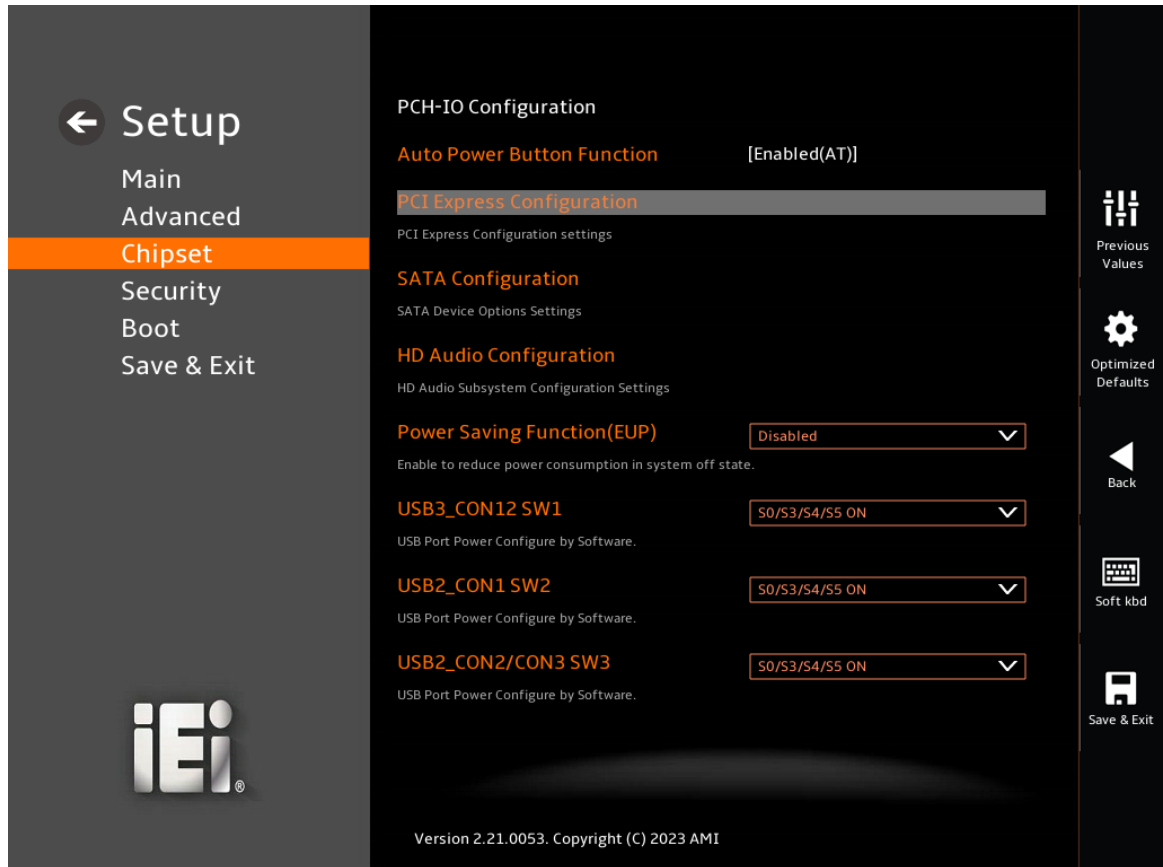

BIOS Menu 24: PCH-IO Configuration

➔ Auto Power Button Function [Disabled (AT)]

Use the **Auto Power Button Function** BIOS option to show the power mode state. Use the **J_ATX_AT1** to switch the AT/ATX power mode.

- ➔ **Enabled (AT)** **DEFAULT** The system power mode is AT.
- ➔ **Disabled (ATX)** The system power mode is ATX.

→ **Power Saving Function (EUP) [Disabled]**

Use the **Power Saving Function (EUP)** BIOS option to enable or disable the power saving function.

- **Disabled** **DEFAULT** Power saving function is disabled.
- **Enabled** Power saving function is enabled. It will reduce power consumption when the system is off.

→ **USB Power state [S0/S3/S4/S5 ON]**

Use the **USB Power state option** to enable or disable the USB Power.

- **S0/S3/S4/S5 ON** **DEFAULT** USB Power is on.
- **S3/S4/S5 OFF** USB Power is off.

AFL4-W10/W12/12/W13-EHL Panel PC

5.4.2.1 PCI Express Configuration

Use the **PCI Express Configuration** submenu (**BIOS Menu 25**) to configure the PCI Express slots.

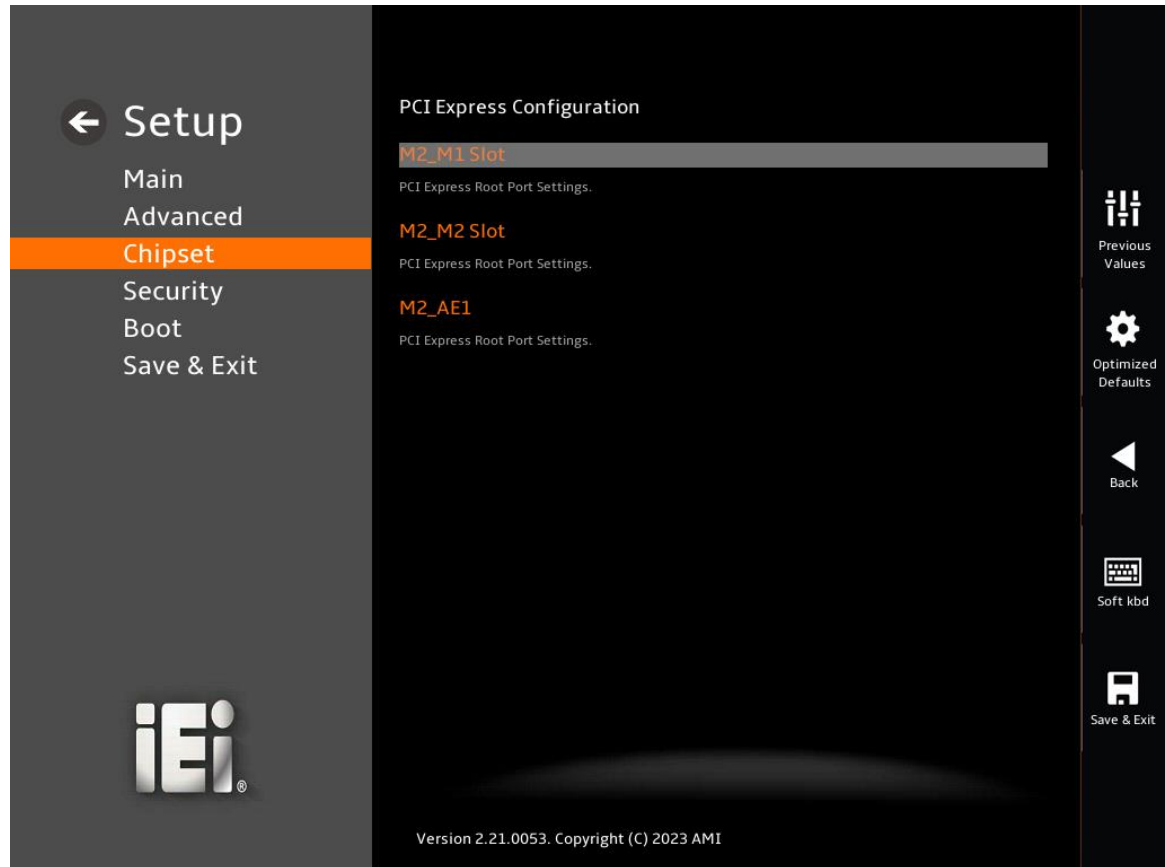

BIOS Menu 25: PCI Express Configuration

5.4.2.1.1 PCIe Root Port Setting

Use the **M.2 Slot (M2_M1)**, **PCIE7 Slot (x1)**, **PCIE6 Slot (x4)**, **PCIE1 Slot (x4)** submenu (**BIOS Menu 26**) to configure the PCIe Root Port Setting.

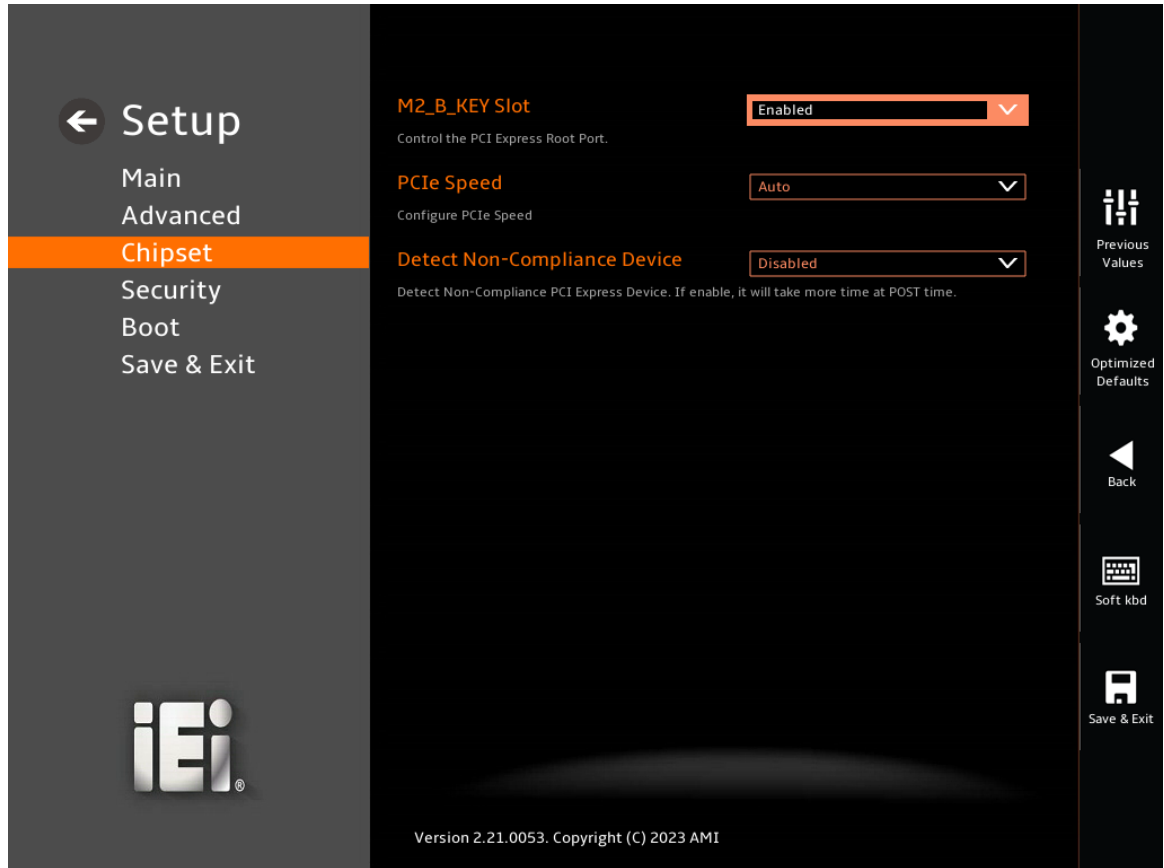

BIOS Menu 26: PCIe Slot Configuration Submenu

➔ **PCIe Speed [Auto]**

Use the **PCIe Speed** option to specify the PCI Express port speed. Configuration options are listed below.

- | | | | |
|---|-------------|----------------|-------------------------------|
| ➔ | Auto | DEFAULT | Auto mode. |
| ➔ | Gen1 | | Configure PCIe Speed to Gen1. |
| ➔ | Gen2 | | Configure PCIe Speed to Gen2. |
| ➔ | Gen3 | | Configure PCIe Speed to Gen3. |

AFL4-W10/W12/12/W13-EHL Panel PC

→ Detect Non-Compliance Device [Disabled]

Use the **Detect Non-Compliance Device** option to configure whether to detect if a non-compliance PCI Express device is connected to the PCI Express port.

- **Disabled** **DEFAULT** Do not detect if a non-compliance PCI Express device is connected to the PCI Express port.

- **Enabled** Detect if a non-compliance PCI Express device is connected to the PCI Express port.

5.4.2.2 SATA Configuration

Use the **SATA Configuration** menu (**BIOS Menu 27**) to change and/or set the configuration of the SATA devices installed in the system.

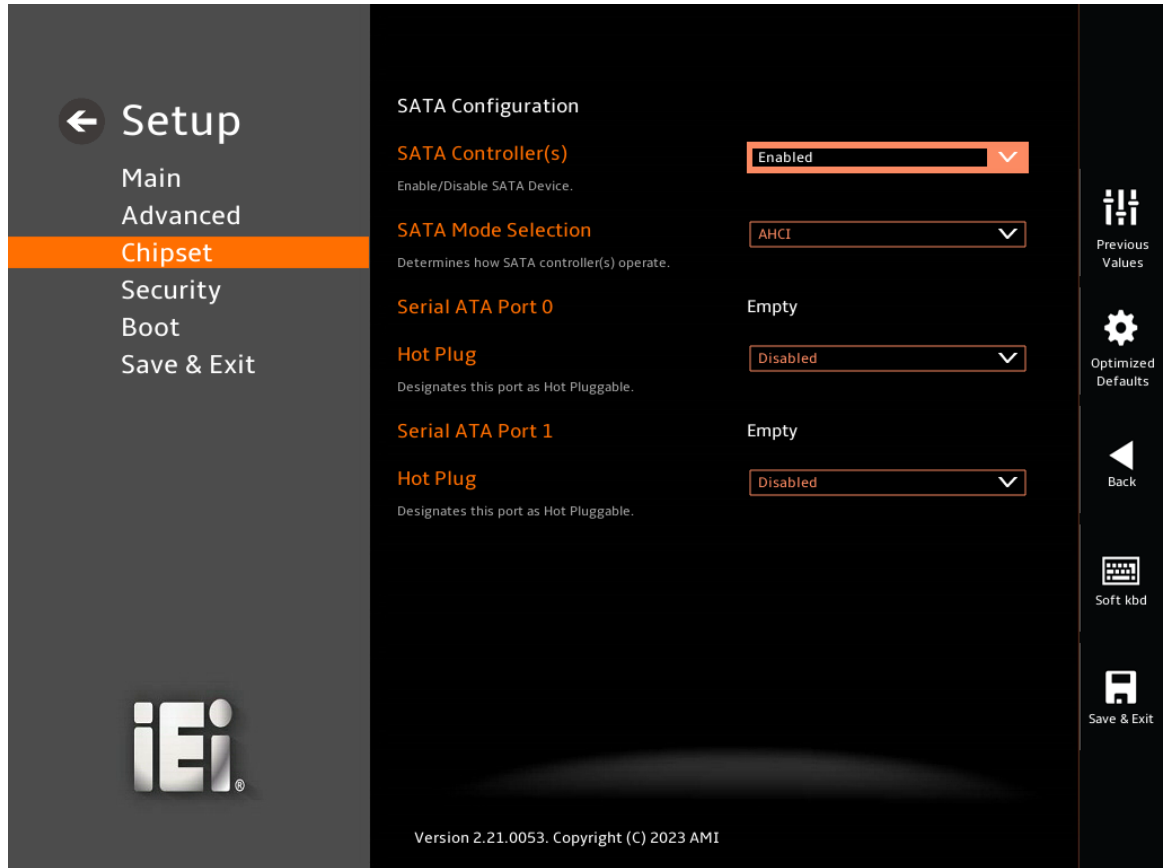

BIOS Menu 27: SATA Configuration

→ SATA Mode Selection [AHCI]

Use the **SATA Mode Selection** option to determine how the SATA devices operate.

- **AHCI** **DEFAULT** Configures SATA devices as AHCI device.
- **Intel RST Premium With Intel Optane System Acceleration** Configures SATA devices to the Intel RST Premium With Intel Optane System Acceleration mode.

→ Hot Plug [Disabled]

AFL4-W10/W12/12/W13-EHL Panel PC

Use the **Hot Plug** option to designate the correspondent port as hot-pluggable.

- ➔ **Disabled** **DEFAULT** Disables the hot-pluggable function of the SATA port.
- ➔ **Enabled** Designates the SATA port as hot-pluggable.

5.4.2.3 HD Audio Configuration

Use the **HD Audio Configuration** menu (**BIOS Menu 28**) to configure the PCH Azalia settings.

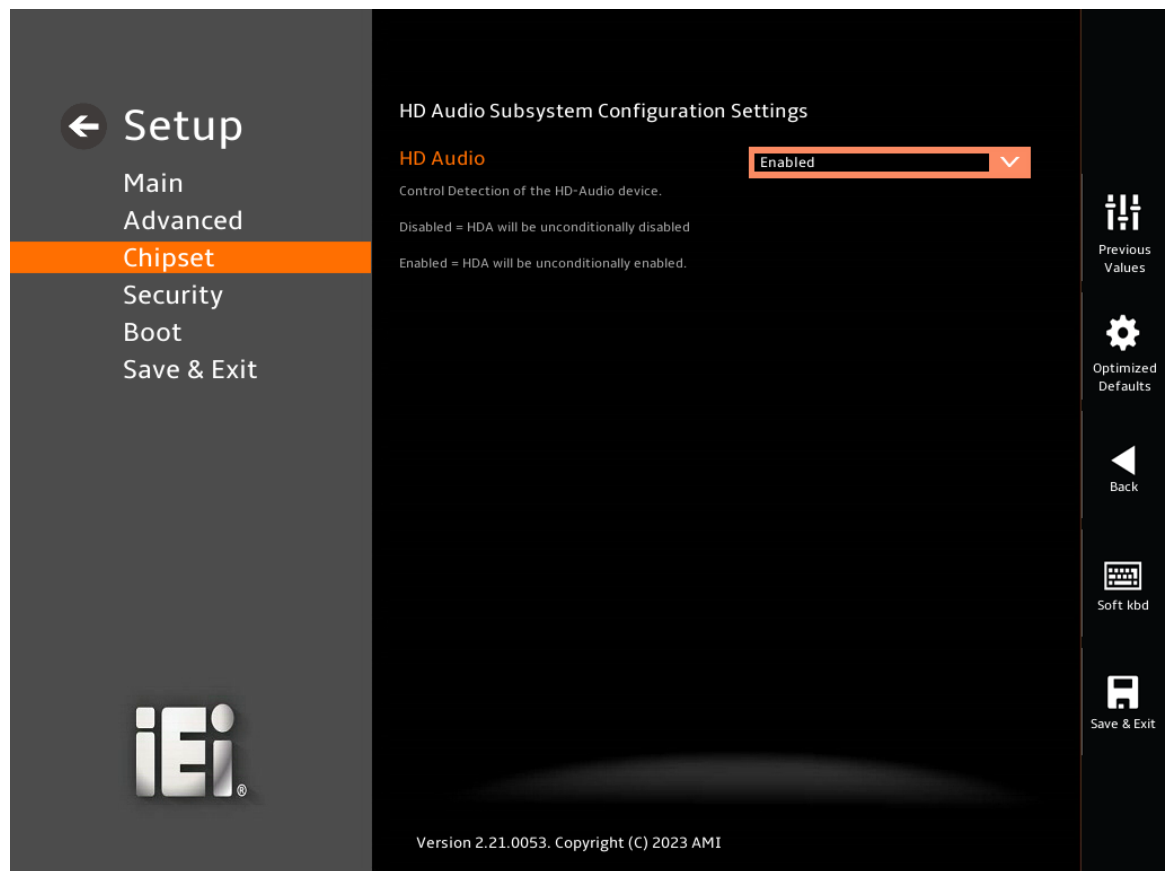

BIOS Menu 28: HD Audio Configuration

- ➔ **HD Audio [Enabled]**

Use the **HD Audio** option to enable or disable the High Definition Audio controller.

- ➔ **Disabled** The onboard High Definition Audio controller is disabled.
- ➔ **Enabled** **DEFAULT** The onboard High Definition Audio controller is enabled.

5.5 Security

Use the **Security** menu (**BIOS Menu 30**) to set system and user passwords.

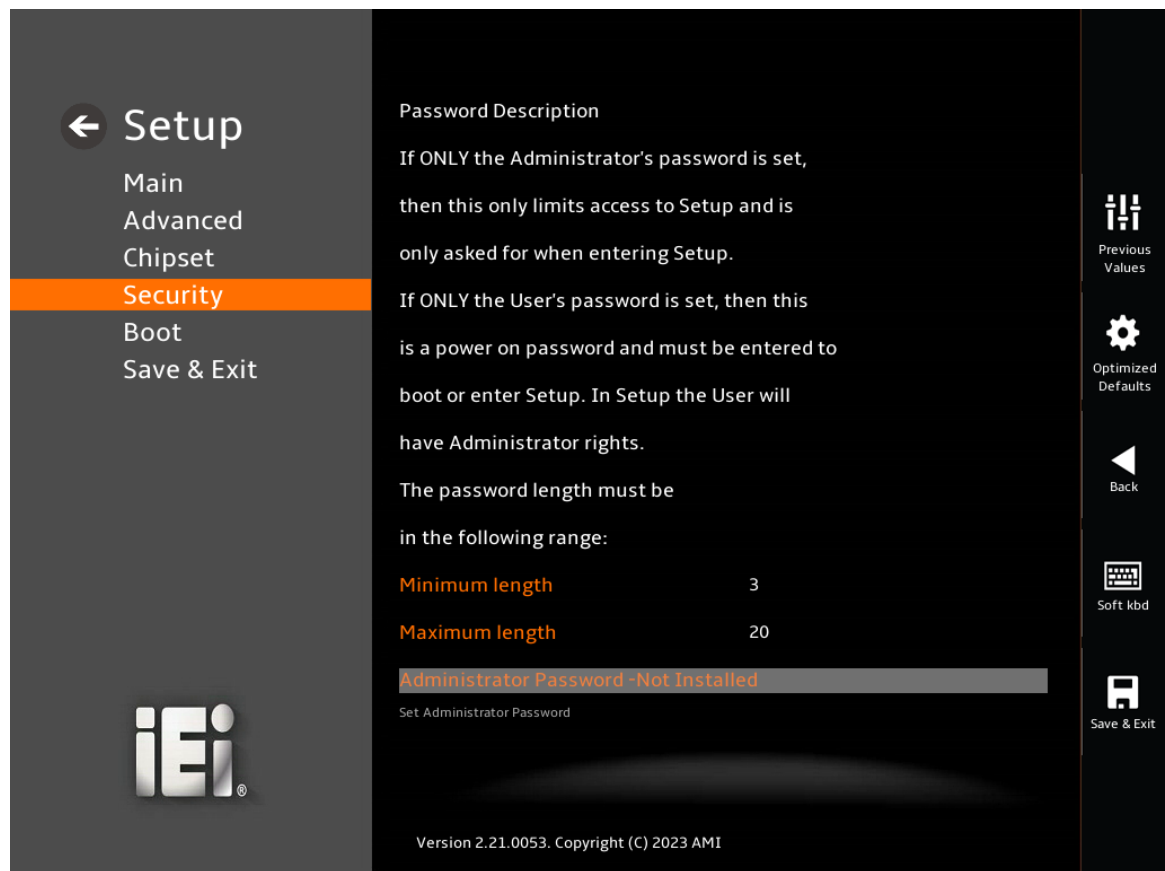

BIOS Menu 29: Security (1/2)



BIOS Menu 30: Security (2/2)

→ Administrator Password

Use the **Administrator Password** to set or change an administrator password.

→ User Password

Use the **User Password** to set or change a user password.

5.6 Boot

Use the **Boot** menu (**BIOS Menu 31**) to configure system boot options.

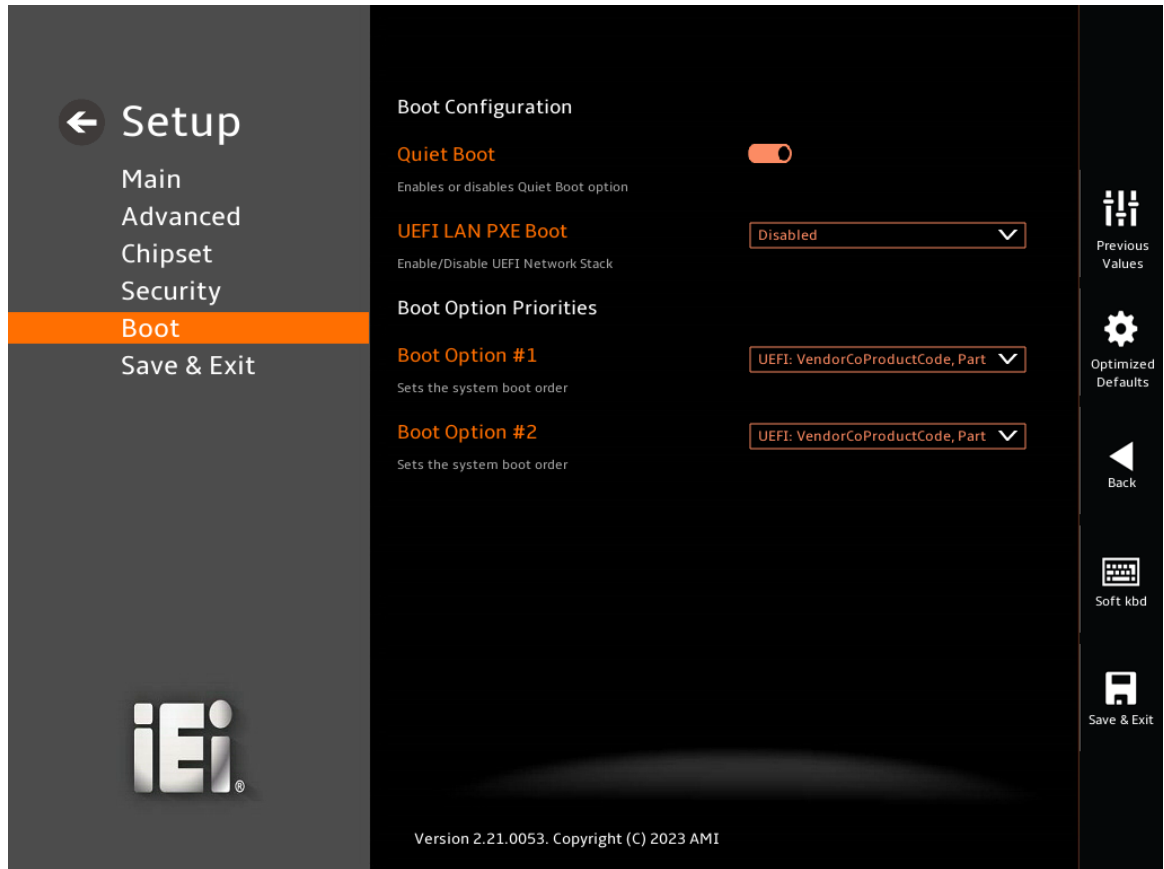

BIOS Menu 31: Boot

5.6.1 Boot Configuration

→ Quiet Boot [Enabled]

Use the **Quiet Boot** BIOS option to select the screen display when the system boots.

- **Disabled** Normal POST messages displayed
- **Enabled** **DEFAULT** OEM Logo displayed instead of POST messages

AFL4-W10/W12/12/W13-EHL Panel PC

→ Launch PXE OpROM [Disabled]

Use the **Launch PXE OpROM** option to enable or disable boot option for legacy network devices.

- **Disabled** **DEFAULT** Ignore all PXE Option ROMs
- **Enabled** Load PXE Option ROMs.

5.6.2 Boot Option Priorities

Use the Boot Option # N to choose the system boots from the peripherals you selected. The following Boot Options are listed as an example.

→ Boot Option #1

Sets the system boot order **ADATA SP580** as the first priority.

- **Windows Boot Manager (P1: ADATA SSD SP580 240GB)**
- **Disabled**

→ Boot Option #2

Sets the system boot order **USB Partition 1** as the second priority.

- **UEFI: USB, Partition 1**
- **Disabled**

5.7 Save & Exit

Use the **Save & Exit** menu (**BIOS Menu 32**) to load default BIOS values, optimal failsafe values and to save configuration changes.

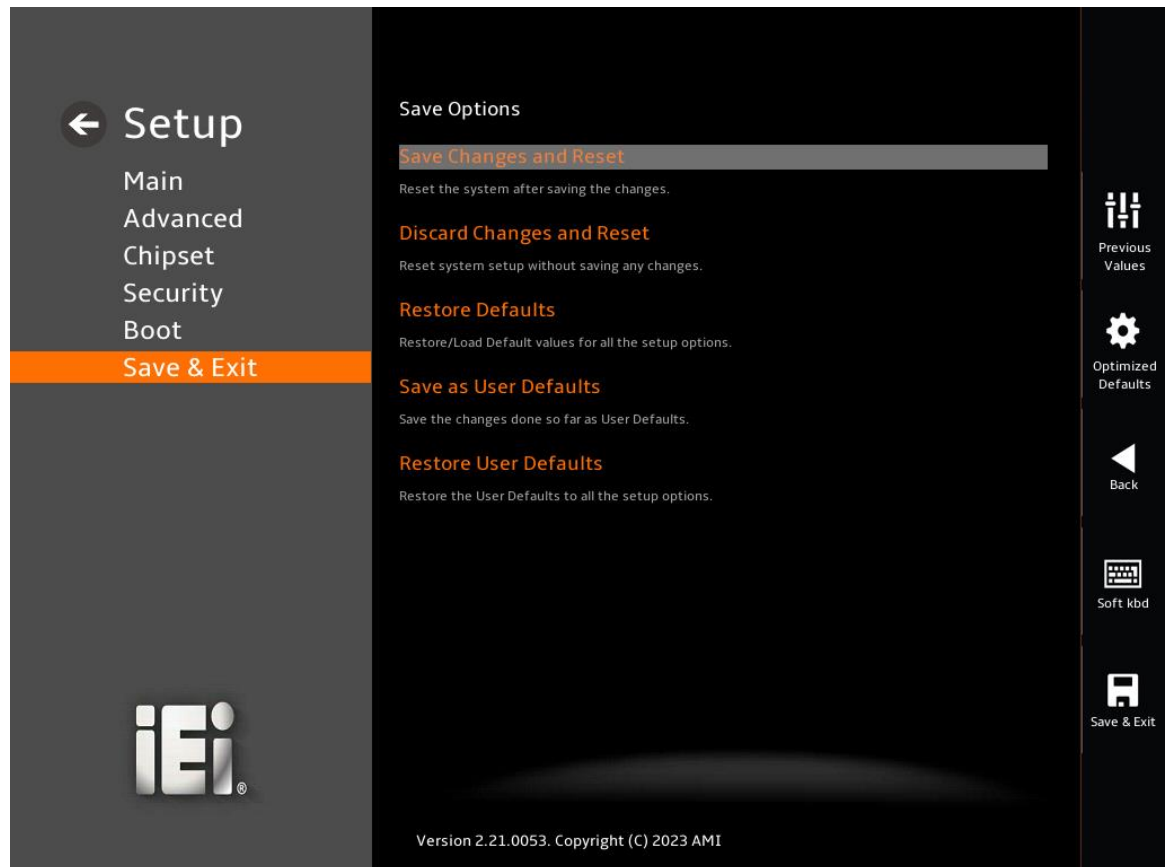

BIOS Menu 32: Save & Exit

→ Save Changes and Reset

Use the **Save Changes and Reset** option to save the changes made to the BIOS options and reset the system.

→ Discard Changes and Reset

Use the **Discard Changes and Reset** option to exit the system without saving the changes made to the BIOS configuration setup program.

AFL4-W10/W12/12/W13-EHL Panel PC

→ Restore Defaults

Use the **Restore Defaults** option to load the optimal default values for each of the parameters on the Setup menus. **F3 key can be used for this operation.**

→ Save as User Defaults

Use the **Save as User Defaults** option to save the changes done so far as user defaults.

→ Restore User Defaults

Use the **Restore User Defaults** option to restore the user defaults to all the setup options.

Chapter

6

Connectors

AFL4-W10/W12/12/W13-EHL Panel PC

6.1 Peripheral Interface Connectors

The AFL4-W10/W12/12/W13-EHL panel PC motherboard comes with a number of peripheral interface connectors and configuration jumpers. The connector locations are shown in **Figure 6-1** and **Figure 6-2**. The connector pinouts for these connectors are listed in the following sections.

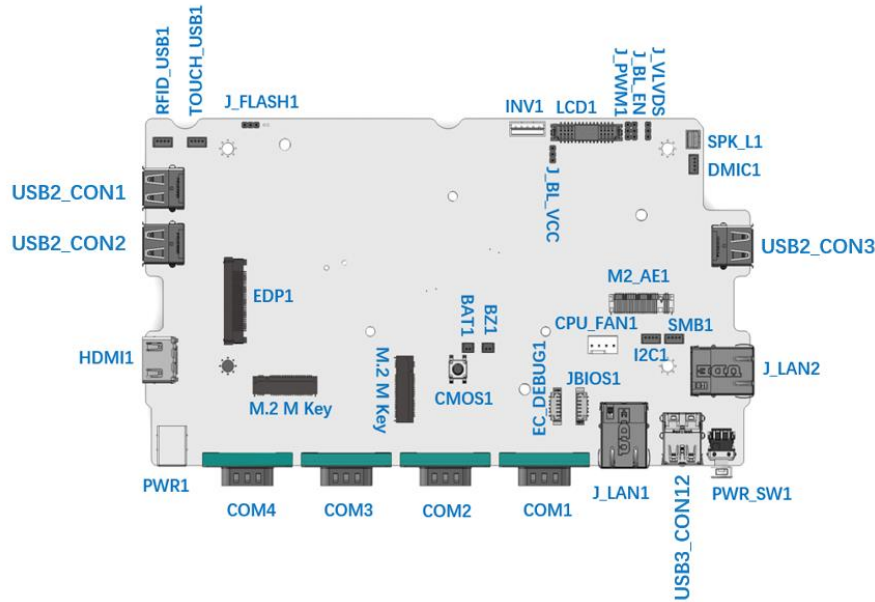

Figure 6-1: Main Board Layout Diagram (Front Side)

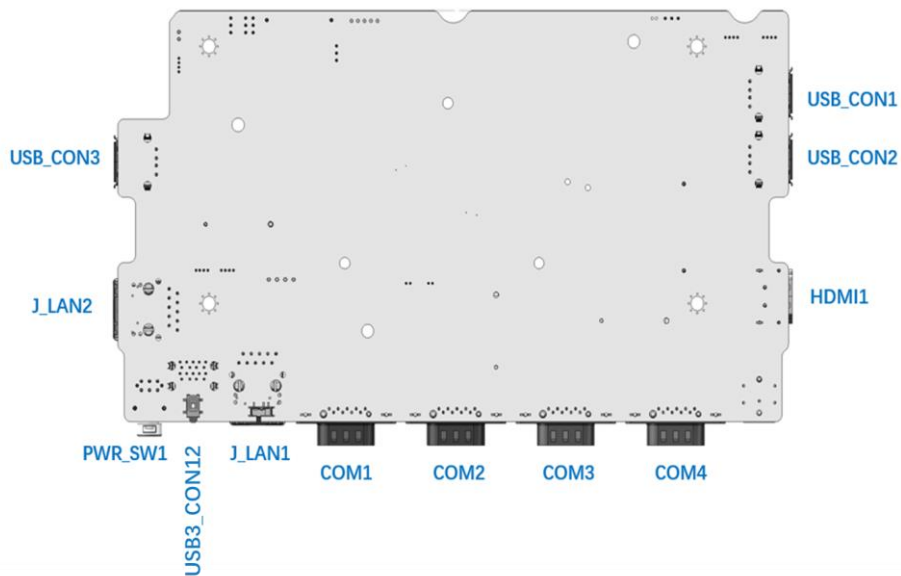

Figure 6-2: Main Board Layout Diagram (Solder Side)

6.2 Internal Peripheral Connectors

Internal peripheral connectors are found on the motherboard and are only accessible when the motherboard is outside of the chassis. The table below shows a list of the peripheral interface connectors on the AFL4-W10/W12/12/W13-EHL motherboard. Pinouts of these connectors can be found in the following sections.

| Connector | Type | Label |
|----------------------------|------------------|------------|
| Touch Panel Connector | 4-pin wafer | TOUCH_USB1 |
| Flash SPI ROM Connector | 6-pin wafer | JBIO1 |
| EC Debug Port Connector | 6-pin wafer | EC_DEBUG1 |
| Speaker Connector | 2-pin wafer | SPK_L1 |
| RFID Connector | 4-pin wafer | RFID_USB1 |
| Digital MIC Connector | 4-pin wafer | DMIC1 |
| I ² C Connector | 4-pin wafer | I2C1 |
| SMBus Connector | 4-pin wafer | SMB1 |
| Battery Connector | 2-pin header | BAT1 |
| M.2 A-Key Slot | A-key slot | M2_AE1 |
| M.2 M-Key Slot | M-key slot | M2_M1 |
| M.2 M-Key slot | M-key slot | M2_M1 |
| eDP Connector | 40-pin connector | EDP1 |
| LVDS Connector | 30-pin connector | LCD1 |
| LVDS Backlight Power | 5-pin connector | INV1 |
| CPU Fan Connector | 4-pin wafer | CPU_FAN1 |

Table 6-1: Peripheral Interface Connectors

6.2.1 Touch Panel Connector (TOUCH_USB1)

| PIN NO. | DESCRIPTION |
|---------|-------------|
| 1 | +5V |
| 2 | -DATA |
| 3 | +DATA |
| 4 | GND |

Table 6-2: Touch Panel Connector (TOUCH_USB1) Pinouts

AFL4-W10/W12/12/W13-EHL Panel PC

6.2.2 Flash SPI ROM Connector (JBIOS1)

| PIN NO. | DESCRIPTION |
|---------|-------------|
| 1 | +3.3V |
| 2 | SPI_CS# |
| 3 | SPI_SO |
| 4 | SPI_CLK |
| 5 | SPI_SI |
| 6 | GND |

Table 6-3: Flash SPI ROM Connector (JBIOS1) Pinouts

6.2.3 EC Debug Port Connector (EC_DEBUG1)

| PIN NO. | DESCRIPTION | PIN NO. | DESCRIPTION |
|---------|-------------|---------|-------------|
| 1 | NC | 4 | EDICLK |
| 2 | EDICS | 5 | EDIDI |
| 3 | EDIDO | 6 | GND |

Table 6-4: EC Debug Port Connector (EC_DEBUG1) Pinouts

6.2.4 Speaker Connector (SPK_L1)

| PIN NO. | DESCRIPTION |
|---------|-------------|
| 1 | SPK-L+ |
| 2 | SPK-L- |

Table 6-5: Speaker Connector (SPK_L1) Pinouts

6.2.5 RFID Connector (RFID_USB1)

| PIN NO. | DESCRIPTION | PIN NO. | DESCRIPTION |
|---------|-------------|---------|-------------|
| 1 | +5V | 3 | +DATA |
| 2 | -DATA | 4 | GND |

Table 6-6: RFID Connector (RFID_USB1) Pinouts

6.2.6 Digital MIC Connector (DMIC1)

| PIN NO. | DESCRIPTION | PIN NO. | DESCRIPTION |
|---------|-------------|---------|-------------|
| 1 | DMIC_CLK | 3 | DMIC_DATA |
| 2 | VCC | 4 | GND |

Table 6-7: Digital MIC Connector (DMIC1) Pinouts

6.2.7 I²C Connector (I2C1)

| PIN NO. | DESCRIPTION | PIN NO. | DESCRIPTION |
|---------|----------------|---------|---------------|
| 1 | GND | 3 | SMB_CLK_LIGHT |
| 2 | SMB_DATA_LIGHT | 4 | +5V |

Table 6-8: I²C Connector (I2C1) Pinouts

6.2.8 SMBus Connector (SMB1)

| PIN NO. | DESCRIPTION |
|---------|-------------|
| 1 | GND |
| 2 | SMB_DATA |
| 3 | SMB_CLK |
| 4 | +5V |

Table 6-9: SMBus Connector (SMB1) Pinouts

6.2.9 Battery Connector (BAT1)

| PIN NO. | DESCRIPTION | PIN NO. | DESCRIPTION |
|---------|-------------|---------|-------------|
| 1 | +V3.3A | 2 | GND |

Table 6-10: Battery Connector (BAT1) Pinouts

6.2.10 M.2 A-Key Slot (M2_AE1)

| PIN NO. | DESCRIPTION | PIN NO. | DESCRIPTION |
|---------|-------------|---------|-------------|
| 1 | GND | 2 | +3.3V |
| 3 | USB2_DP | 4 | +3.3V |
| 5 | USB2_DN | 6 | NC |

AFL4-W10/W12/12/W13-EHL Panel PC

| PIN NO. | DESCRIPTION | PIN NO. | DESCRIPTION |
|---------|-------------|---------|-------------|
| 7 | GND | 8 | NC |
| 9 | NC | 10 | NC |
| 11 | NC | 12 | NC |
| 13 | NC | 14 | NC |
| 15 | NC | 16 | NC |
| 17 | NC | 18 | GND |
| 19 | NC | 20 | NC |
| 21 | NC | 22 | NC |
| 23 | GND | 24 | GND |
| 25 | NC | 26 | NC |
| 27 | NC | 28 | NC |
| 29 | GND | 30 | GND |
| 31 | NC | 32 | NC |
| 33 | GND | 34 | NC |
| 35 | PETP0 | 36 | GND |
| 37 | PETN0 | 38 | NC |
| 39 | GND | 40 | NC |
| 41 | PERP0 | 42 | NC |
| 43 | PERN0 | 44 | NC |
| 45 | GND | 46 | NC |
| 47 | PCIE_CLK+ | 48 | NC |
| 49 | PCIE_CLK- | 50 | NC |
| 51 | GND | 52 | PLT_RST |
| 53 | CLKREQ0# | 54 | Pull up |
| 55 | PCIE_WAKE | 56 | W_DIS |
| 57 | GND | 58 | I2C_DAT |
| 59 | NC | 60 | I2C_CLK |
| 61 | NC | 62 | NC |
| 63 | GND | 64 | NC |
| 65 | NC | 66 | NC |
| 67 | NC | 68 | NC |
| 69 | GND | 70 | +3.3V |

| PIN NO. | DESCRIPTION | PIN NO. | DESCRIPTION |
|---------|-------------|---------|-------------|
| 71 | NC | 72 | +3.3V |
| 73 | NC | 74 | +3.3V |
| 75 | GND | | |

Table 6-11: M.2 A-Key Slot (M2_AE1) Pinouts

6.2.11 M.2 M-Key Slot (M2_M1)

| PIN NO. | DESCRIPTION | PIN NO. | DESCRIPTION |
|---------|-------------|---------|-------------|
| 1 | GND | 2 | +3.3V |
| 3 | GND | 4 | +3.3V |
| 5 | PERN3 | 6 | NC |
| 7 | PERP3 | 8 | NC |
| 9 | GND | 10 | DAS/DSS# |
| 11 | PETN3 | 12 | +3.3V |
| 13 | PETP3 | 14 | +3.3V |
| 15 | GND | 16 | +3.3V |
| 17 | PERN2 | 18 | +3.3V |
| 19 | PERP2 | 20 | NC |
| 21 | GND | 22 | NC |
| 23 | PETN2 | 24 | NC |
| 25 | PETP2 | 26 | NC |
| 27 | GND | 28 | NC |
| 29 | PERN1 | 30 | NC |
| 31 | PERP1 | 32 | NC |
| 33 | GND | 34 | NC |
| 35 | PETN1 | 36 | NC |
| 37 | PETP1 | 38 | DEVSLP |
| 39 | GND | 40 | NC |
| 41 | PERN0 | 42 | NC |
| 43 | PERP0 | 44 | NC |
| 45 | GND | 46 | NC |
| 47 | PETN0 | 48 | NC |
| 49 | PETP0 | 50 | PERST# |

AFL4-W10/W12/12/W13-EHL Panel PC

| PIN NO. | DESCRIPTION | PIN NO. | DESCRIPTION |
|---------|-------------|---------|-------------|
| 51 | GND | 52 | CLKREQ |
| 53 | PCIECLKN | 54 | PEWAKE |
| 55 | PCIECLKP | 56 | NC |
| 57 | GND | 58 | NC |
| 59 | NC | 60 | NC |
| 61 | NC | 62 | NC |
| 63 | NC | 64 | NC |
| 65 | NC | 66 | NC |
| 67 | NC | 68 | NC |
| 69 | PEDET | 70 | +3.3V |
| 71 | GND | 72 | +3.3V |
| 73 | GND | 74 | +3.3V |
| 75 | GND | | +3.3V |

Table 6-12: M.2 M-Key Slot (M2_M1) Pinouts

6.2.12 M.2 M-Key Slot (M2_M2)

| PIN NO. | DESCRIPTION | PIN NO. | DESCRIPTION |
|---------|-------------|---------|-------------|
| 1 | GND | 2 | +3.3V |
| 3 | GND | 4 | +3.3V |
| 5 | PERN3 | 6 | NC |
| 7 | PERP3 | 8 | NC |
| 9 | GND | 10 | DAS/DSS# |
| 11 | PETN3 | 12 | +3.3V |
| 13 | PETP3 | 14 | +3.3V |
| 15 | GND | 16 | +3.3V |
| 17 | PERN2 | 18 | +3.3V |
| 19 | PERP2 | 20 | NC |
| 21 | GND | 22 | NC |
| 23 | PETN2 | 24 | NC |
| 25 | PETP2 | 26 | NC |
| 27 | GND | 28 | NC |
| 29 | PERN1 | 30 | NC |

| PIN NO. | DESCRIPTION | PIN NO. | DESCRIPTION |
|---------|-------------|---------|-------------|
| 31 | PERP1 | 32 | NC |
| 33 | GND | 34 | NC |
| 35 | PETN1 | 36 | NC |
| 37 | PETP1 | 38 | DEVSLP |
| 39 | GND | 40 | NC |
| 41 | PERN0 | 42 | NC |
| 43 | PERP0 | 44 | NC |
| 45 | GND | 46 | NC |
| 47 | PETN0 | 48 | NC |
| 49 | PETP0 | 50 | PERST# |
| 51 | GND | 52 | CLKREQ |
| 53 | PCIECLKN | 54 | PEWAKE |
| 55 | PCIECLKP | 56 | NC |

Table 6-13: M.2 M-Key Slot (M2_M2) Pinouts
6.2.13 eDP Connector (EDP1)

| PIN NO. | DESCRIPTION | PIN NO. | DESCRIPTION |
|---------|-------------|---------|-----------------|
| 1 | NC | 21 | VCC_LCD |
| 2 | GND | 22 | NC |
| 3 | (eDP_TX3-) | 23 | GND |
| 4 | (eDP_TX3+) | 24 | GND |
| 5 | GND | 25 | GND |
| 6 | (eDP_TX2-) | 26 | GND |
| 7 | (eDP_TX2+) | 27 | eDP_HPDP |
| 8 | GND | 28 | GND |
| 9 | (eDP_TX1-) | 29 | GND |
| 10 | (eDP_TX1+) | 30 | GND |
| 11 | GND | 31 | GND |
| 12 | (eDP_TX0-) | 32 | (eDP_BKLT_EN) |
| 13 | (eDP_TX0+) | 33 | (eDP_BKLT_CRTL) |
| 14 | GND | 34 | NC |
| 15 | (eDP_AUX+) | 35 | NC |

AFL4-W10/W12/12/W13-EHL Panel PC

| PIN NO. | DESCRIPTION | PIN NO. | DESCRIPTION |
|---------|-------------|---------|-------------|
| 16 | (eDP_AUX-) | 36 | BKLT_PWR |
| 17 | GND | 37 | BKLT_PWR |
| 18 | VCC_LCD | 38 | BKLT_PWR |
| 19 | VCC_LCD | 39 | BKLT_PWR |
| 20 | VCC_LCD | 40 | NC |

Table 6-14: eDP Connector (EDP1) Pinouts

6.2.14 LVDS Connector (LCD1)

| PIN NO. | DESCRIPTION | PIN NO. | DESCRIPTION |
|---------|----------------|---------|----------------|
| 1 | GND | 2 | GND |
| 3 | A0P_L | 4 | A0M_L |
| 5 | A1P_L | 6 | A1M_L |
| 7 | A2P_L | 8 | A2M_L |
| 9 | CLK1P_L | 10 | CLK1M_L |
| 11 | A3P_L | 12 | A3M_L |
| 13 | GND | 14 | GND |
| 15 | A4P_L | 16 | A4M_L |
| 17 | A5P_L | 18 | A5M_L |
| 19 | A6P_L | 20 | A6M_L |
| 21 | CLK2P_L | 22 | CLK2M_L |
| 23 | A7P_L | 24 | A7M_L |
| 25 | GND | 26 | GND |
| 27 | +VCC_LCD_BEAD2 | 28 | +VCC_LCD_BEAD2 |
| 29 | +VCC_LCD_BEAD2 | 30 | +VCC_LCD_BEAD2 |

Table 6-15: LVDS Connector (LCD1) Pinouts

6.2.15 LVDS Backlight Power (INV1)

| PIN NO. | DESCRIPTION |
|---------|-------------|
| 1 | LCD_BKLTCTL |
| 2 | GROUND |
| 3 | +12V |

| | |
|---|------------------|
| 4 | GROUND |
| 5 | BACKLIGHT ENABLE |

Table 6-16: LVDS Backlight Power (INV1) Pinouts

6.2.16 CPU Fan Connector (CPU_FAN1)

| PIN NO. | DESCRIPTION | PIN NO. | DESCRIPTION |
|---------|-------------|---------|-------------|
| 1 | GND | 3 | FANIO |
| 2 | +12V | 4 | PWM(+5V) |

Table 6-17: CPU Fan Connector (CPU_FAN1) Pinouts

6.3 Jumper less Setting

| Jumper | Type | LABEL |
|----------------------------|--------------|----------|
| PWM Power Selection | 3-pin header | J_PWM1 |
| Backlight Enable Selection | 3-pin header | J_BL_EN |
| Backlight VCC Selection | 3-pin header | J_BL_VCC |
| LVDS Power Selection | 3-pin header | J_VLVDS |
| Flash Mode Header | 3-pin header | J_FLASH1 |

Table 6-18: Jumper less Setting

6.3.1 PWM Power Selection (J_PWM1)

| J_PWM1 | DESCRIPTION |
|--------|----------------|
| 1-2 | +3.3V(Default) |
| 2-3 | +5V |

Table 6-19: PWM Power Selection (J_PWM1)

6.3.2 Backlight Enable Selection (J_BL_EN)

| J_BL_EN | DESCRIPTION |
|---------|----------------|
| 1-2 | +3.3V(Default) |
| 2-3 | +5V |

Table 6-20: Backlight Enable Selection (J_BL_EN)

AFL4-W10/W12/12/W13-EHL Panel PC

6.3.3 Backlight VCC Selection (J_BL_VCC)

| J_BL_VCC | DESCRIPTION |
|----------|----------------|
| 1-2 | +3.3V(Default) |
| 2-3 | +5V |

Table 6-21: Backlight VCC Selection (J_BL_VCC)

6.3.4 LVDS Power Selection (J_VLVDS1)

| J_VLVDS1 | DESCRIPTION |
|----------|----------------|
| 1-2 | +3.3V(Default) |
| 2-3 | +5V |

Table 6-22: LVDS Power Selection (J_VLVDS1)

6.3.5 Flash Descriptor Security Override

| J_FLASH1 | DESCRIPTION |
|---------------|------------------|
| 1-2(default)* | Disabled-Default |
| Short 2-3 | Enabled |

Table 6-23: Flash Descriptor Security Override

6.4 External Interface Panel Connectors

The table below lists the rear panel connectors on the AFL4-W10/W12/12/W13-EHL motherboard. Pinouts of these connectors can be found in the following sections.

| Connector | Type | Label |
|-----------------------------|--------------------|---------------|
| RS-232/422/485 Serial ports | DB-9 | COM1/2/3/4 |
| RJ45 LAN Connector | RJ45 | J_LAN2 |
| HDMI Connector | HDMI | HDMI1 |
| USB 3.2 Gen 2 Connectors | USB 3.2 Gen 2 port | USB3_CON12 |
| USB 2.0 Connectors | USB 2.0 port | USB2_CON1/2/3 |
| DC Input Connector | DC Jack | PWR1 |
| Power Button | Push button | PWR_SW1 |

Table 6-24: External Interface Panel Connectors

6.4.1 RS-232/422/485 Serial Ports (COM1/2/3/4)

| PIN NO. | DESCRIPTION |
|---------|---------------------------|
| 1 | DATA CARRIER DETECT (DCD) |
| 2 | RECEIVE DATA (RXD) |
| 3 | TRANSMIT DATA (TXD) |
| 4 | DATA TERMINAL READY (DTR) |
| 5 | GND (GND) |
| 6 | DATA SET READY (DSR) |
| 7 | REQUEST TO SEND (RTS1/2) |
| 8 | CLEAR TO SEND (CTS1/2) |
| 9 | RING INDICATOR (RI1/2) |

Table 6-25: External Serial Port Connector (COM1/2/3/4) Pinouts

6.4.2 RJ45 LAN Connector (J_LAN1/2)

| PIN NO. | DESCRIPTION | PIN NO. | DESCRIPTION |
|---------|-------------|---------|-------------|
| R1 | GND | R7 | TRD1P2 |
| R2 | TRD1P0 | R8 | TRD1N2 |
| R3 | TRD1N0 | R9 | TRD1P3 |
| R4 | TRD1P1 | R10 | TRD1N3 |
| R5 | TRD1N1 | R11 | GND |
| R6 | GND | | |

Table 6-26: LAN Connector (J_LAN1/2) Pinouts

6.4.1 HDMI Connector (HDMI1)

| PIN NO. | DESCRIPTION | PIN NO. | DESCRIPTION |
|---------|-------------|---------|-------------|
| 1 | HDMI_DATA2 | 13 | N/C |
| 2 | GND | 14 | N/C |
| 3 | HDMI_DATA2# | 15 | HDMI_SCL |
| 4 | HDMI_DATA1 | 16 | HDMI_SDA |
| 5 | GND | 17 | GND |
| 6 | HDMI_DATA1# | 18 | +5V |
| 7 | HDMI_DATA0 | 19 | HDMI_HPD |

AFL4-W10/W12/12/W13-EHL Panel PC

| PIN NO. | DESCRIPTION | PIN NO. | DESCRIPTION |
|---------|-------------|---------|-------------|
| 8 | GND | G1 | HDMI_GND |
| 9 | HDMI_DATA0# | G2 | HDMI_GND |
| 10 | HDMI_CLK | G3 | HDMI_GND |
| 11 | GND | G4 | HDMI_GND |
| 12 | HDMI_CLK# | G5 | HDMI_GND |

Table 6-27: HDMI1 Connector (HDMI1) Pinouts

6.4.2 USB 2.0 Connectors (USB2_CON1/2/3)

| PIN NO. | DESCRIPTION |
|---------|-------------|
| 1 | +5V |
| 2 | USB_PN- |
| 3 | USB_PP+ |
| 4 | GND |

Table 6-28: USB 2.0 Connectors (USB2_CON1/2/3) Pinouts

6.4.3 USB 3.2 Gen 2 Connectors (USB3_CON12)

| PIN NO. | DESCRIPTION |
|---------|-------------|
| 1 | +5V |
| 2 | USB_PN- |
| 3 | USB_PP+ |
| 4 | GND |
| 5 | USB3_RX_N |
| 6 | USB3_RX_P |
| 7 | GND |
| 8 | USB3_TX_N |
| 9 | USB3_TX_P |

Table 6-29: USB 3.2 Gen 2 Connectors (USB3_CON12) Pinouts

6.4.4 Power Button (PWR_SW1)

| PIN NO. | DESCRIPTION | PIN NO. | DESCRIPTION |
|---------|-------------|---------|-------------|
| 1 | +3V | 2 | GND |

Table 6-30: Power Button (PWR_SW1) Pinouts

6.4.5 DC Jack

| PIN NO. | DESCRIPTION |
|---------|-------------|
| 1 | GND |
| 2 | 12V |

Table 6-31: DC Jack Connector

Appendix

A

Regulatory Compliance

DECLARATION OF CONFORMITY



This equipment is in conformity with the following EU directives:

- EMC Directive (2014/30/EU)
- Low-Voltage Directive (2014/35/EU)
- RoHS II Directive (2015/863/EU)

If the user modifies and install other devices in the equipment, the CE conformity declaration may no longer apply.

If this equipment has telecommunications functionality, it also complies with the requirements of the Radio Equipment Directive 2014/53/EU.

| | | | | | | | | | | | |
|---|----|----|----|----|----|----|----|----|----|----|------------|
|  | AT | BE | BG | CH | CY | CZ | DE | DK | EE | EL | ES |
| | FI | FR | HR | HU | IE | IS | IT | LI | LT | LU | LV |
| | MT | NL | NO | PL | PT | RO | SE | SI | SK | TR | UK (NI) |

English

IEI Integration Corp declares that this equipment is in compliance with the essential requirements and other relevant provisions of Directive 2014/53/EU.

Български [Bulgarian]

IEI Integration Corp. декларира, че този оборудване е в съответствие със съществените изисквания и другите приложими правила на Директива 2014/53/EU.

AFL4-W10/W12/12/W13-EHL Panel PC

Česky [Czech]

IEI Integration Corp tímto prohlašuje, že tento zařazení je ve shodě se základními požadavky a dalšími příslušnými ustanoveními směrnice 2014/53/EU.

Dansk [Danish]

IEI Integration Corp erklærer herved, at følgende udstyr overholder de væsentlige krav og øvrige relevante krav i direktiv 2014/53/EU.

Deutsch [German]

IEI Integration Corp, erklärt dieses Gerät entspricht den grundlegenden Anforderungen und den weiteren entsprechenden Vorgaben der Richtlinie 2014/53/EU.

Eesti [Estonian]

IEI Integration Corp deklareerib seadme seadme vastavust direktiivi 2014/53/EÜ põhinõuetele ja nimetatud direktiivist tulenevatele teistele asjakohastele sätetele.

Español [Spanish]

IEI Integration Corp declara que el equipo cumple con los requisitos esenciales y cualesquiera otras disposiciones aplicables o exigibles de la Directiva 2014/53/EU.

Ελληνική [Greek]

IEI Integration Corp ΔΗΛΩΝΕΙ ΟΤΙ ΕΞΟΠΛΙΣΜΟΣ ΣΥΜΜΟΡΦΩΝΕΤΑΙ ΠΡΟΣ ΤΙΣ ΟΥΣΙΩΔΕΙΣ ΑΠΑΙΤΗΣΕΙΣ ΚΑΙ ΤΙΣ ΛΟΙΠΕΣ ΣΧΕΤΙΚΕΣ ΔΙΑΤΑΞΕΙΣ ΤΗΣ ΟΔΗΓΙΑΣ 2014/53/EU.

Français [French]

IEI Integration Corp déclare que l'appareil est conforme aux exigences essentielles et aux autres dispositions pertinentes de la directive 2014/53/EU.

Italiano [Italian]

IEI Integration Corp dichiara che questo apparecchio è conforme ai requisiti essenziali ed alle altre disposizioni pertinenti stabilite dalla direttiva 2014/53/EU.

Latviski [Latvian]

IEI Integration Corp deklarē, ka iekārta atbilst būtiskajām prasībām un citiem ar to saistītajiem noteikumiem Direktīvas 2014/53/EU.

Lietuvių [Lithuanian]

IEI Integration Corp deklaruoja, kad šis įranga atitinka esminius reikalavimus ir kitas 2014/53/EU Direktyvos nuostatas.

Nederlands [Dutch]

IEI Integration Corp dat het toestel toestel in overeenstemming is met de essentiële eisen en de andere relevante bepalingen van richtlijn 2014/53/EU.

Malti [Maltese]

IEI Integration Corp jiddikjara li dan prodott jikkonforma mal-ħtiġijiet essenzjali u ma provvedimenti oħrajn relevanti li hemm fid-Dirrettiva 2014/53/EU.

Magyar [Hungarian]

IEI Integration Corp nyilatkozom, hogy a berendezés megfelel a vonatkozó alapvető követelményeknek és az 2014/53/EU irányelv egyéb előírásainak.

Polski [Polish]

IEI Integration Corp oświadcza, że wyrobu jest zgodny z zasadniczymi wymogami oraz pozostałymi stosownymi postanowieniami Dyrektywy 2014/53/EU.

Português [Portuguese]

IEI Integration Corp declara que este equipamento está conforme com os requisitos essenciais e outras disposições da Directiva 2014/53/EU.

Româna [Romanian]

IEI Integration Corp declară că acest echipament este în conformitate cu cerințele esențiale și cu celelalte prevederi relevante ale Directivei 2014/53/EU.

Slovensko [Slovenian]

IEI Integration Corp izjavlja, da je ta opreme v skladu z bistvenimi zahtevami in ostalimi relevantnimi določili direktive 2014/53/EU.

Slovensky [Slovak]

IEI Integration Corp týmto vyhlasuje, že zariadenia spĺňa základné požiadavky a všetky príslušné ustanovenia Smernice 2014/53/EU.

Suomi [Finnish]

IEI Integration Corp vakuuttaa täten että laitteen on direktiivin 2014/53/EU oleellisten vaatimusten ja sitä koskevien direktiivin muiden ehtojen mukainen.

Svenska [Swedish]

IEI Integration Corp förklarar att denna utrustningstyp står i överensstämmelse med de väsentliga egenskapskrav och övriga relevanta bestämmelser som framgår av direktiv 2014/53/EU.

AFL4-W10/W12/12/W13-EHL Panel PC

ROHS STATEMENT



The label on the product indicates this product conforms to European (EU) Restriction of Hazardous Substances (RoHS) that set maximum concentration limits on hazardous materials used in electrical and electronic equipment.



UKCA WARNING

Hereby, IEI INTEGRATION CORP declares that the radio equipment type AFL4-W10-EHL , AFL4-W12-EHL、AFL4-12-EHL、AFL4-W13-EHL are in compliance with the Radio Equipment Regulations 2017(S.I. 2017/1206).

The full text of the system UK declaration of conformity is available at :

<https://www.ieiworld.com>



FCC WARNING

This equipment complies with Part 15 of the FCC Rules. Operation is subject to the following two conditions:

- This device may not cause harmful interference, and
- This device must accept any interference received, including interference that may cause undesired operation.

This equipment has been tested and found to comply with the limits for a Class A digital device, pursuant to part 15 of the FCC Rules. These limits are designed to provide reasonable protection against harmful interference when the equipment is operated in a commercial environment. This equipment generates, uses, and can radiate radio frequency energy and, if not installed and used in accordance with the instruction manual, may cause harmful interference to radio communications. Operation of this equipment in a residential area is likely to cause harmful interference in which case the user will be required to correct the interference at his own expense.

Any changes or modifications not expressly approved by the party responsible for compliance could void the user's authority to operate the equipment.

This equipment complies with FCC radiation exposure limits set forth for an uncontrolled environment. This equipment should be installed and operated with a minimum distance of 20cm between the radiator & your body.

CHINA ROHS

The label on the product indicates the estimated “Environmentally Friendly Use Period” (EFUP). This is an estimate of the number of years that these substances would “not leak out or undergo abrupt change.” This product may contain replaceable sub-assemblies/components which have a shorter EFUP such as batteries and lamps. These components will be separately marked.

Appendix

B

Safety Precautions

**WARNING:**

The precautions outlined in this chapter should be strictly followed. Failure to follow these precautions may result in permanent damage to the AFL4-W10/W12/12/W13-EHL.

B.1 Safety Precautions

Please follow the safety precautions outlined in the sections that follow:

B.1.1 General Safety Precautions

Please ensure the following safety precautions are adhered to at all times.

- **Follow the electrostatic precautions** outlined below whenever the device is opened.
- **Make sure the power is turned off and the power cord is disconnected** whenever the AFL4-W10/W12/12/W13-EHL is being installed, moved or modified.
- **To prevent the risk of electric shock, make sure power cord is unplugged from wall socket.** To fully disengage the power to the unit, please disconnect the power cord from the AC outlet. Refer servicing to qualified service personnel. The AC outlet shall be readily available and accessible.
- **Do not apply voltage levels that exceed the specified voltage range.** Doing so may cause fire and/or an electrical shock. Use a power cord that matches the voltage of the power outlet, which has been approved and complies with the safety standard of your particular country.
- **Electric shocks can occur** if the AFL4-W10/W12/12/W13-EHL chassis is opened when it is running. To avoid risk of electric shock, this device must only be connected to a supply mains with protective earth.
- **Do not drop or insert any objects** into the ventilation openings of the AFL4-W10/W12/12/W13-EHL.

AFL4-W10/W12/12/W13-EHL Panel PC

- ***If considerable amounts of dust, water, or fluids enter the device***, turn off the power supply immediately, unplug the power cord, and contact the AFL4-W10/W12/12/W13-EHL vendor.
- **RTC battery safety precautions:**
 - RISK OF EXPLOSION IF BATTERY IS REPLACED BY AN INCORRECT TYPE
 - Disposal of a battery into fire or a hot oven, or mechanically crushing or cutting of a battery, that can result in an explosion
 - Leaving a battery in an extremely high temperature surrounding environment that can result in an explosion or the leakage of flammable liquid or gas
 - A battery subjected to extremely low air pressure that may result in an explosion or the leakage of flammable liquid or gas
- **DO NOT:**
 - Drop the device against a hard surface.
 - Strike or exert excessive force onto the LCD panel.
 - Touch any of the LCD panels with a sharp object
 - In a site where the ambient temperature exceeds the rated temperature

B.1.2 Anti-static Precautions



WARNING:

Failure to take ESD precautions during the installation of the AFL4-W10/W12/12/W13-EHL may result in permanent damage to the AFL4-W10/W12/12/W13-EHL and severe injury to the user.

Electrostatic discharge (ESD) can cause serious damage to electronic components, including the AFL4-W10/W12/12/W13-EHL. Dry climates are especially susceptible to ESD. It is therefore critical that whenever the AFL4-W10/W12/12/W13-EHL is opened and any of the electrical components are handled, the following anti-static precautions are strictly adhered to.

- **Wear an anti-static wristband:** Wearing a simple anti-static wristband can help to prevent ESD from damaging any electrical component.
- **Self-grounding:** Before handling any electrical component, touch any grounded conducting material. During the time the electrical component is handled, frequently touch any conducting materials that are connected to the ground.
- **Use an anti-static pad:** When configuring or working with an electrical component, place it on an anti-static pad. This reduces the possibility of ESD damage.
- **Only handle the edges of the electrical component:** When handling the electrical component, hold the electrical component by its edges.

B.1.3 Product Disposal



CAUTION:

Risk of explosion if battery is replaced by an incorrect type. Only certified engineers should replace the on-board battery.

Dispose of used batteries according to instructions and local regulations.

- Outside the European Union–If you wish to dispose of used electrical and electronic products outside the European Union, please contact your local authority so as to comply with the correct disposal method.
- Within the European Union–The device that produces less waste and is easier to recycle is classified as electronic device in terms of the European Directive 2012/19/EU (WEEE), and must not be disposed of as domestic garbage.

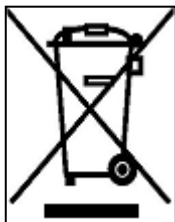

EU-wide legislation, as implemented in each Member State, requires that waste electrical and electronic products carrying the mark (left) must be disposed of separately from normal household waste. This includes monitors and electrical accessories, such as signal cables or power

AFL4-W10/W12/12/W13-EHL Panel PC

cords. When you need to dispose of your display products, please follow the guidance of your local authority, or ask the shop where you purchased the product. The mark on electrical and electronic products only applies to the current European Union Member States.

Please follow the national guidelines for electrical and electronic product disposal.

B.2 Maintenance and Cleaning Precautions

When maintaining or cleaning the AFL4-W10/W12/12/W13-EHL, please follow the guidelines below.



WARNING:

- For safety reasons, turn-off the power and unplug the panel PC before cleaning.
 - If you dropped any material or liquid such as water onto the panel PC when cleaning, unplug the power cable immediately and contact your dealer or the nearest service center. Always make sure your hands are dry when unplugging the power cable.
-

B.2.1 Maintenance and Cleaning

Prior to cleaning any part or component of the AFL4-W10/W12/12/W13-EHL, please read the details below.

- Except for the LCD panel, never spray or squirt liquids directly onto any other components. To clean the LCD panel, gently wipe it with a piece of soft dry cloth or a slightly moistened cloth.
- The interior of the device does not require cleaning. Keep fluids away from the device interior.
- Be cautious of all small removable components when vacuuming the device.
- Never drop any objects or liquids through the openings of the device.
- Be cautious of any possible allergic reactions to solvents or chemicals used when cleaning the device.
- Avoid eating, drinking and smoking within vicinity of the device.

B.2.2 Cleaning Tools

Some components in the AFL4-W10/W12/12/W13-EHL may only be cleaned using a product specifically designed for the purpose. In such case, the product will be explicitly mentioned in the cleaning tips. Below is a list of items to use when cleaning the AFL4-W10/W12/12/W13-EHL.

- **Cloth**— Although paper towels or tissues can be used, a soft, clean piece of cloth is recommended when cleaning the device.
- **Water or rubbing alcohol**—A cloth moistened with water or rubbing alcohol can be used to clean the device.
- **Using solvents**—The use of solvents is not recommended when cleaning the device as they may damage the plastic parts.
- **Vacuum cleaner**—Using a vacuum specifically designed for computers is one of the best methods of cleaning the device. Dust and dirt can restrict the airflow in the device and cause its circuitry to corrode.
- **Cotton swabs**—Cotton swabs moistened with rubbing alcohol or water are excellent tools for wiping hard to reach areas.
- **Foam swabs**—Whenever possible, it is best to use lint free swabs such as foam swabs for cleaning.

Appendix

C

Watchdog Timer



NOTE:

The following discussion applies to DOS. Contact IEI support or visit the IEI website for drivers for other operating systems.

The Watchdog Timer is a hardware-based timer that attempts to restart the system when it stops working. The system may stop working because of external EMI or software bugs. The Watchdog Timer ensures that standalone systems like ATMs will automatically attempt to restart in the case of system problems.

A BIOS function call (INT 15H) is used to control the Watchdog Timer.

INT 15H:

| AH – 6FH Sub-function: | |
|-------------------------------|---|
| AL – 2: | Sets the Watchdog Timer’s period. |
| BL: | Time-out value (Its unit-second is dependent on the item “Watchdog Timer unit select” in CMOS setup). |

Table C-1: AH-6FH Sub-function

Call sub-function 2 to set the time-out period of Watchdog Timer first. If the time-out value is not zero, the Watchdog Timer starts counting down. When the timer value reaches zero, the system resets. To ensure that this reset condition does not occur, calling sub-function 2 must periodically refresh the Watchdog Timer. However, the watchdog timer is disabled if the time-out value is set to zero.

A tolerance of at least 10% must be maintained to avoid unknown routines within the operating system (DOS), such as disk I/O that can be very time-consuming.

AFL4-W10/W12/12/W13-EHL Panel PC

**NOTE:**

The Watchdog Timer is activated through software. The software application that activates the Watchdog Timer must also deactivate it when closed. If the Watchdog Timer is not deactivated, the system will automatically restart after the Timer has finished its countdown.

EXAMPLE PROGRAM:

; INITIAL TIMER PERIOD COUNTER

;

W_LOOP:

;

```

MOV      AX, 6F02H      ;setting the time-out value
MOV      BL, 30         ;time-out value is 48 seconds
INT      15H

```

;

; ADD THE APPLICATION PROGRAM HERE

;

```

CMP      EXIT_AP, 1     ;is the application over?
JNE      W_LOOP        ;No, restart the application

MOV      AX, 6F02H     ;disable Watchdog Timer
MOV      BL, 0         ;
INT      15H

```

;

; EXIT ;

Appendix

D

Hazardous Materials Disclosure

AFL4-W10/W12/12/W13-EHL Panel PC

D.1.1 RoHS II Directive (2015/863/EU)

The details provided in this appendix are to ensure that the product is compliant with the RoHS II Directive (2015/863/EU). The table below acknowledges the presences of small quantities of certain substances in the product, and is applicable to RoHS II Directive (2015/863/EU).

Please refer to the following table.

| Part Name | Toxic or Hazardous Substances and Elements | | | | | | | | | |
|---|--|--------------|--------------|------------------------------|--------------------------------|---------------------------------------|------------------------------------|------------------------------|-------------------------|-----------------------------|
| | Lead (Pb) | Mercury (Hg) | Cadmium (Cd) | Hexavalent Chromium (CR(VI)) | Polybrominated Biphenyls (PBB) | Polybrominated Diphenyl Ethers (PBDE) | Bis(2-ethylhexyl) phthalate (DEHP) | Butyl benzyl phthalate (BBP) | Dibutyl phthalate (DBP) | Diisobutyl phthalate (DIBP) |
| Housing | O | O | O | O | O | O | O | O | O | O |
| Printed Circuit Board | O | O | O | O | O | O | O | O | O | O |
| Metal Fasteners | O | O | O | O | O | O | O | O | O | O |
| Cable Assembly | O | O | O | O | O | O | O | O | O | O |
| Fan Assembly | O | O | O | O | O | O | O | O | O | O |
| Power Supply Assemblies | O | O | O | O | O | O | O | O | O | O |
| Battery | O | O | O | O | O | O | O | O | O | O |
| <p>O: This toxic or hazardous substance is contained in all of the homogeneous materials for the part is below the limit requirement in Directive (EU) 2015/863.</p> <p>X: This toxic or hazardous substance is contained in at least one of the homogeneous materials for this part is above the limit requirement in Directive (EU) 2015/863.</p> | | | | | | | | | | |

D.1.2 China RoHS

此附件旨在确保本产品符合中国 RoHS 标准。以下表格标示此产品中某有毒物质的含量符合中国 RoHS 标准规定的限量要求。

本产品上会附有“环境友好使用期限”的标签，此期限是估算这些物质“不会有泄漏或突变”的年限。本产品可能包含有较短的环境友好使用期限的可替换元件，像是电池或灯管，这些元件将会单独标示出来。

| 部件名称 | 有毒有害物质或元素 | | | | | |
|--------|-----------|--------|--------|--------------|------------|--------------|
| | 铅 (Pb) | 汞 (Hg) | 镉 (Cd) | 六价铬 (Cr(VI)) | 多溴联苯 (PBB) | 多溴二苯醚 (PBDE) |
| 壳体 | ○ | ○ | ○ | ○ | ○ | ○ |
| 印刷电路板 | ○ | ○ | ○ | ○ | ○ | ○ |
| 金属螺帽 | ○ | ○ | ○ | ○ | ○ | ○ |
| 电缆组装 | ○ | ○ | ○ | ○ | ○ | ○ |
| 风扇组装 | ○ | ○ | ○ | ○ | ○ | ○ |
| 电力供应组装 | ○ | ○ | ○ | ○ | ○ | ○ |
| 电池 | ○ | ○ | ○ | ○ | ○ | ○ |

○: 表示该有毒有害物质在该部件所有物质材料中的含量均在 SJ/T11364-2014 與 GB/T26572-2011 标准规定的限量要求以下。

X: 表示该有毒有害物质至少在该部件的某一均质材料中的含量超出 SJ/T11364-2014 與 GB/T26572-2011 标准规定的限量要求。