

PCM-9340

**ISA STPC Elite 133 SBC with
CPU/32MB SDRAM/VGA/LCD/
LAN/DOC/PC104**

Users Manual

Copyright

This document is copyrighted, © 2002, by EMAC, Inc. All rights reserved. The original manufacturer reserves the right to make improvements to the products described in this manual at any time without notice.

No part of this manual may be reproduced, copied, translated or transmitted in any form or by any means without the prior written permission of the original manufacturer. Information provided in this manual is intended to be accurate and reliable. However, the original manufacturer assumes no responsibility for its use, nor for any infringements upon the rights of third parties that may result from such use.

Acknowledgements

Award is a trademark of Award Software International, Inc.

VIA is a trademark of VIA Technologies, Inc.

IBM, PC/AT, PS/2 and VGA are trademarks of International Business Machines Corporation.

Intel and Pentium are trademarks of Intel Corporation.

Microsoft Windows® is a registered trademark of Microsoft Corp.

RTL is a trademark of Realtek Semi-Conductor Co., Ltd.

ESS is a trademark of ESS Technology, Inc.

UMC is a trademark of United Microelectronics Corporation.

SMI is a trademark of Silicon Motion, Inc.

Creative is a trademark of Creative Technology LTD.

All other product names or trademarks are properties of their respective owners.

For more information on this and other EMAC products, please visit our website at: **<http://www.emacinc.com>**

For technical support and service, please visit our support website at: **http://www.emacinc.com/technical_support.htm**

This manual is for the PCM-9340 3.5" Biscuit SBC.

Packing List

Before you begin installing your card, please make sure that the following materials have been shipped:

- 1 PCM-9340 all-in-one single board computer
- 1 startup manual
- 1 CD-ROM or disk for utilities, drivers, and manual
(in PDF format)
- 1 3.5" IDE flat cable P/N: (1701440504)
- 1 keyboard/mouse cable P/N: (1700060202)
- 1 secondary serial port cable P/N: (1701140201)
- 1 parallel cable P/N: (1700260250)
- 1 floppy cable P/N: (1701340603)
- 1 COM3/COM4 cable P/N: (1701200220)
- 1 Mini Jumper package (10 PCS) P/N: (9689000002)

If any of these items are missing or damaged, contact your distributor or sales representative immediately.

The PCM-9340 Series Model Comparison Table				
	CPU	32MB Memory	VGA/LCD	Ethernet
PCM-9340F-0CA1	v	v	v	v
PCM-9340V-0CA1	v	v	v	
PCM-9340N-0CA1	v	v		v

Contents

Chapter 1	General Information	1
1.1	Introduction	2
1.2	Features	3
1.3	Specifications	4
1.3.1	Standard SBC functions	4
1.3.2	Flat Panel/VGA Interface	4
1.3.3	Ethernet Interface (PCM-9340F and PCM-9340N)	5
1.3.4	Audio Interface (optional)	5
1.3.5	Mechanical and Environmental	5
1.3.6	Solid state disk	5
1.4	Board layout: dimensions	6
	Figure 1.1:Board layout: dimensions	6
Chapter 2	Connecting Peripherals	7
2.1	Jumpers.....	8
2.1.1	Jumper Locations	8
	Figure 2.1:Jumper Locations	8
2.1.2	Jumper Functions	9
2.1.3	Setting Jumpers.....	9
2.2	COM2 Select (JP2).....	10
2.3	Watchdog Timer Action (JP3)	10
2.4	DOC© 2000 Address Setting (JP4)	11
2.5	Clear CMOS (JP5)	12
2.6	Audio Amp Power Select (JP7)	12
2.7	Connectors.....	13
2.7.1	Connector Locations	13
	Figure 2.2:Connector Locations	13
2.7.2	Connector Functions	14
2.8	Making Connections	15
2.9	CPU Fan power supply connector (CN1)	15
2.10	Serial ports (CN2, CN3, CN4)	15
2.10.1	COM3/COM4 RS-232 port (CN2)	15
2.10.2	COM2 RS-232/422/485 selection (CN3)	16
2.10.3	COM1 RS-232 port (CN4)	16
2.10.4	Share IRQ	16
2.11	PC/104 connectors (CN5)	16
2.12	Ethernet Connections (CN6, LED1, LED2).....	16
2.12.1	100Base-T RJ-45 connector (CN6)	17
2.12.2	Network boot	17
2.12.3	Ethernet LED and HDD/power LEDs	17
2.13	Keyboard and PS/2 mouse connector (CN7)	17

2.14	IR connector (CN8).....	18
2.15	Enhanced IDE HDD Connector (CN9).....	18
2.16	VGA interface connections (CN10, CN15, CN19).....	18
2.16.1	CRT display connector (CN10).....	18
2.16.2	Extension flat panel connector (CN15).....	19
2.16.3	Flat panel display connector (CN19).....	19
2.17	Audio interfaces (CN11, CN17) (optional).....	19
2.17.1	Audio connector (CN11).....	19
2.17.2	CD audio input connector (CN17).....	19
2.17.3	Audio power source setting (JP7).....	19
2.18	ATX power (CN13, CN16, CN22).....	21
	Figure 2.3:Wiring for ATX feature power.....	21
2.18.1	ATX feature connector (CN13).....	21
2.18.2	Board Main Power (CN16).....	21
2.18.3	ATX soft power switch (CN22).....	21
2.19	FDD connector (CN14).....	22
2.20	Parallel port connector (CN18).....	22
2.21	General Purpose Input Output (CN20).....	22

Chapter 3 Award BIOS Setup.....23

3.1	System test and initialization.....	24
3.1.1	System configuration verification.....	24
3.2	Award BIOS setup.....	25
3.2.1	Entering setup.....	25
	Figure 3.1:BIOS setup program initial screen.....	25
3.2.2	Standard CMOS Features setup.....	26
	Figure 3.2:CMOS Features setup.....	26
3.2.3	Advanced BIOS Features setup.....	27
	Figure 3.3:Advanced BIOS Features setup.....	27
3.2.4	Advanced Chipset Features setup.....	28
	Figure 3.4:Advanced Chipset Features setup.....	28
3.2.5	Integrated Peripherals.....	29
	Figure 3.5:Integrated Peripherals.....	29
3.2.6	Power Management Setup.....	30
	Figure 3.6:Power Management Setup.....	30
3.2.7	PnP/PCI Configurations.....	31
	Figure 3.7:PnP/PCI Configurations.....	31
3.2.8	Load Optimized Defaults.....	32
	Figure 3.8:Load BIOS defaults screen.....	32
3.2.9	Set Password.....	32
	Figure 3.9:Set Password.....	34
3.2.10	Save & Exit Setup.....	35
	Figure 3.10:Save and Exit Setup.....	35
3.2.11	Exit Without Saving.....	36
	Figure 3.11:Exit without Saving.....	36

Chapter 4	SVGA Setup	37
4.1	Introduction	38
4.1.1	Chipset	38
4.1.2	Display memory	38
4.2	Installation of the SVGA Driver	38
4.2.1	Installation for Windows 95	39
4.2.2	Installation for Windows 98	44
4.2.3	Installation for Windows NT	49
4.3	Further Information	54
Chapter 5	PCI Bus Ethernet Interface	55
5.1	Introduction	56
5.2	Ethernet Driver Installation	56
5.2.1	Installation for Windows 95	57
5.2.2	Installation for Windows 98	62
5.2.3	Installation for Windows NT	69
5.3	Further information	71
Chapter 6	Audio Setup	73
6.1	Introduction	74
6.2	Audio Driver Installation	74
6.2.1	Installation for Windows 95/98/NT	75
Appendix A	Programming the Watchdog Timer	77
A.1	Supported Input Timing Modes	78
Appendix B	Installing PC/104 Modules	81
B.1	Installing PC/104 Modules	82
	Figure B.1:PC/104 module mounting diagram	83
	Figure B.2:PC/104 module dimensions (mm) (± 0.1)	84
Appendix C	Pin Assignments	85
C.1	CPU fan power connector (CN1)	86
C.2	COM 3, COM 4 connector (CN2)	86
C.3	COM 2 connector (CN3)	87
C.4	COM 1 RS-232 connector (CN4)	87
C.5	PC/104 Connector (CN5)	88
C.6	Ethernet 10/100Base-T Connector (CN6)	90
C.7	Keyboard and PS/2 Mouse Connector (CN7)	90
C.8	IR Connector (CN8)	91
C.9	IDE Hard Drive Connector (CN9)	92
C.10	CRT Display Connector (CN10)	93
C.11	Audio Connector (optional) (CN11)	93
C.12	LCD Inverter Backlight Connector (CN12)	94
C.13	ATX Power Feature Connector (CN13)	94
C.14	Floppy Disk Drive Connector (CN14)	95

C.15	Extended Flat Panel Display Connector (CN15).....	96
C.16	Main Power Connector (CN16)	96
C.17	CD audio connector (CN17)	96
C.18	Parallel Port Connector (CN18).....	97
C.19	Flat Panel Connector (CN19).....	98
C.20	General Purpose Input Output (CN20).....	99
C.21	Auxiliary power connector (CN21).....	99
C.22	ATX Power Button (CN22)	99
C.23	Reset Button Connector (SW1).....	100
Appendix D	System Assignments	101
D.1	System I/O Ports.....	102
D.2	DMA channel assignments.....	103
D.3	Interrupt assignments	104
D.4	1st MB memory map.....	105
D.5	DMA channel assignments.....	105
D.6	Interrupt assignments	106
Appendix E	Mechanical Drawings.....	107
E.1	Mechanical Drawings.....	108

General Information

This chapter gives background information on the PCM-9340.

Sections include:

- Introduction
- Features
- Specifications
- Board layout and dimensions

Chapter 1 Introduction

1.1 Introduction

The PCM-9340 is the ultimate cost-effective solution for limited-space applications. It offers all the functions of an AT-compatible industrial computer on a single board. The PCM-9340 comes with an embedded high-performance STPC Elite 133 processor and 32MB SDRAM on board. For maximum performance, the PCM-9340 also supports one optional SODIMM socket that can accept up to 64 MB memory.

On-board features include an Ethernet interface, a socket for DOC® 2000, Enhanced IDE interface, one parallel port, four serial ports (three RS-232s, and one RS-232/422/485) with DB-9 connectors, and a mini-DIN PS/2 keyboard/mouse interface, and an optional audio function. An SVGA/LCD display controller (LCD, and CRT displays) allows LCD screen resolutions up to 1024 x 768 @ 64K colors and CRT resolutions up to 1280 x 1024 @ 256 colors.

The PCM-9340 complies with the “Green Function” standard and supports three types of power saving features: Normal, Doze and Sleep modes.

The display type configuration is done through software. A single Flash chip holds the system BIOS and the VGA BIOS. This minimizes the number of chips and eases configuration. You can change the display BIOS simply by programming the Flash chip.

If you need any additional functions, the PCM-9340 has a PC/104 connector for future upgrades.

1.2 Features

- On-board Low power STMicroelectronics STPC Elite 133 processor (fanless)
- On-board 32 MB SDRAM
- On-board VGA/LCD display controller and supports DSTN/TFT LCD
- 62-level watchdog timer, jumperless on-line setup supported
- Supports wake-up on LAN, ring-on by Modem
- SSD supports DiskOnChip® 2000
- Supports CMOS data backup functions
- PC/104 connector supports face-up installation
- Optional audio function

1.3 Specifications

1.3.1 Standard SBC functions

- CPU: Embedded STMicroelectronics STPC Elite 133 MHz processor (provides fanless operation)
- BIOS: 2 Mbit Flash BIOS,
 - Supports Plug & Play, APM
 - Supports Ethernet Boot ROM
 - Supports boot from CD-ROM
 - Supports boot from LS-120 ZIP™ Drive
 - Optional Customer icon can be supplied
- Chipset: STPC Elite 133
- System memory: Onboard 32MB SDRAM, and one optional SDRAM SODIMM max. 64MB socket
- PCI IDE interface: One Enhanced IDE interface. Supports 2 IDE devices PIO mode 3,4 with bus mastering up to 14 MB/sec.
- Floppy disk drive interface: Supports up to two FDDs (360 KB/1.2 MB/720 KB/1.44 MB/2.88 MB)
- Parallel port: One parallel port, supports EPP/ECP
- IR port: One 115 Kbps IrDA compliant serial infrared
- Serial ports: 4 serial ports:: COMs1,3,4: RS-232; COM2: RS-232/422/485; COM2 RS-485 supports Autoflow control
- Watchdog timer: 62-level timer interval, setup by software or jumperless selection, generates system reset or IRQ11.

1.3.2 Flat Panel/VGA Interface (PCM-9340F and PCM-9340V)

- **Chipset:** SMI LynxEM+ 712
- **Display memory:** 2 MB on the chip
- **Display type:** Simultaneous support for CRT and 36-bit TFT LCD display (supports 3.3 V LCD) Supports 3, 9,12,18, 24, 36-bit TFT and 16 or 24-bit DSTN Panel
- **CRT display modes:**
 - 1280 x 1024@16bpp (60Hz)
 - 1024 x 768@16bpp (85Hz)
 - 800 x 600 @24bpp(85Hz)

- **Panel display modes:**

1280 x 1024@16bpp (60Hz)

1024 x 768@16bpp (60Hz)

800 x 600 @24bpp(60Hz)

1.3.3 Ethernet Interface (PCM-9340F and PCM-9340N)

- **Chipset:** RTL 8139C
- **Ethernet interface:** PCI 10/100 Mbps Ethernet. IEEE 802.3 u protocol compatible
- **Connection:** On-board RJ-45 connector
- **Wake on LAN** (via ATX power supply)
- I/O address switchless setting
- Built-in boot ROM

1.3.4 Audio Interface (optional)

- **Chipset:** Avance Logic ALS4000
- PCI Interface, Mic in, Line in, CD Audio in, Line out, speaker out

1.3.5 Mechanical and Environmental

- **Dimensions (L x W):** 145 mm x 102 mm (5.9" x 4.2")
- **Power supply voltage:** +5 V (4.75 V ~ 5.25 V)
- **Power requirements:** Maximum: 5.0 V @ 2 A
Typical: +5.0 V @ 1.62 A
- **Operating temperature:** 0 ~ 60° C (32 ~ 140° F)
- **Operating humidity:** 0% ~ 90% Relative Humidity, non-condensing
- **Weight:** 0.23 Kg (0.5 lbs)
- **Size:** 185 mm x 122 mm

1.3.6 Solid state disk

- Provides support for one DOC® 2000.

1.4 Board layout: dimensions

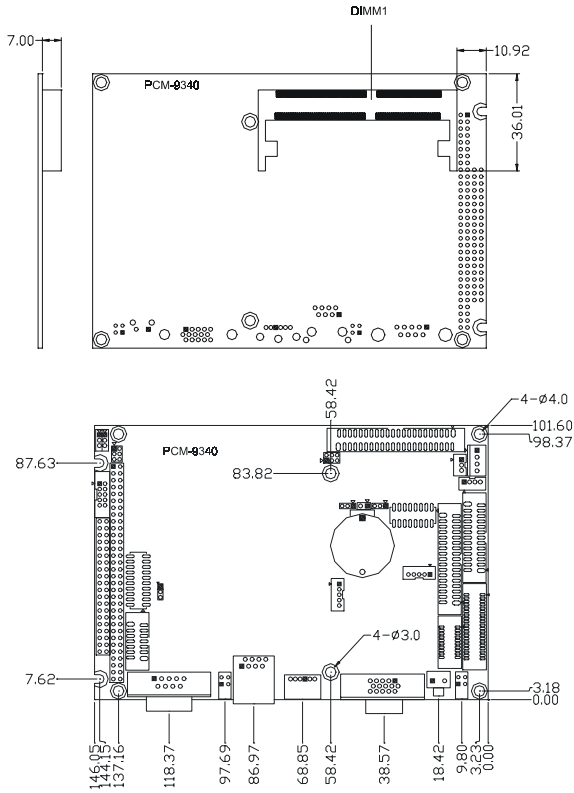

Figure 1.1: Board layout: dimensions

Connecting Peripherals

This chapter tells how to connect peripherals, switches, and indicators to the PCM-9340 board. It also covers jumper settings. You can access most of the connectors from the top of the board while it is installed in the chassis. If you have a number of cards installed, or your chassis is very tight, you may need to partially remove the card to make all the connections.

Chapter 2 Installation

2.1 Jumpers

The PCM-9340 has a number of jumpers that allow you to configure your system to suit your application.

2.1.1 Jumper Locations

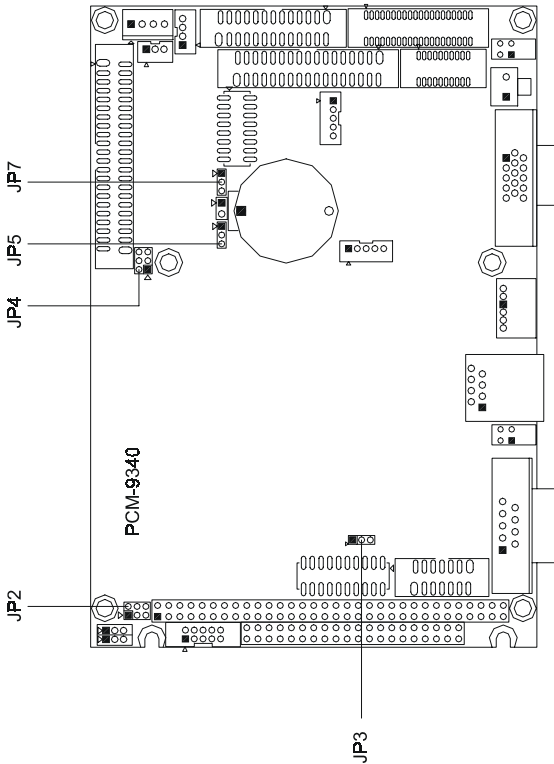

Figure 2.1: Jumper Locations

2.1.2 Jumper Functions

Label	Function
JP2	COM2 selector
JP3	Watchdog timer action
JP4	DOC® 2000 address setting
JP5	Clear CMOS
JP7	Audio power selector

2.1.3 Setting Jumpers

You may configure your card to match the needs of your application by setting jumpers. A jumper is a metal bridge used to close an electric circuit. It consists of two metal pins and a small metal clip (often protected by a plastic cover) that slides over the pins to connect them. To “close” a jumper, you connect the pins with the clip. To “open” a jumper, you remove the clip. Sometimes a jumper will have three pins, labeled 1, 2 and 3. In this case you would connect either pins 1 and 2, or 2 and 3.

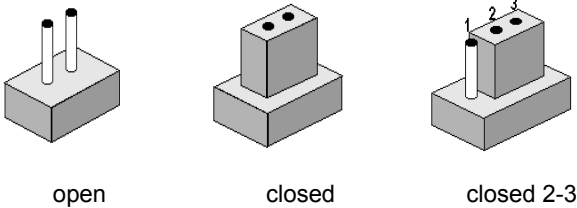

The jumper settings are schematically depicted in this manual as follows:.

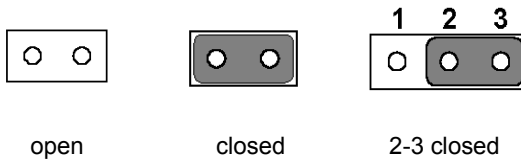

A pair of needle-nose pliers may be helpful when working with jumpers. If you have any doubts about the best hardware configuration for your application, contact your local distributor or sales representative before you make any changes.

2.2 COM2 Select (JP2)

Table 2.2: JP2: COM2 RS-232/422/485 Select

Pins	Function
1-2*	COM2/RS-232*
3-4	COM2/RS-422
5-6	COM2/RS-485

* default setting

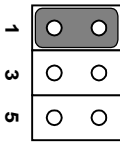

RS-232*

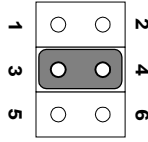

RS-422

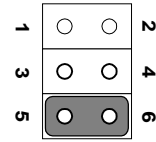

RS-485

2.3 Watchdog Timer Action (JP3)

An on-board watchdog timer reduces the chance of disruptions which EMP (electro-magnetic pulse) interference can cause. This is an invaluable protective device for standalone or unmanned applications. Setup involves one jumper setting and running the control software (refer to Appendix A).

When the watchdog timer activates (CPU processing has come to a halt), it can either reset the system or generate an interrupt on IRQ11. This choice for watchdog timer action is set via JP3 as shown below:

Table 2.3: JP3: Watchdog Timer

Pins	Function
1-2*	Reset
2-3	IRQ 11

* default setting



reset*



IRQ 11

2.4 DOC® 2000 Address Setting (JP4)

Pins			Address
1-2	3-4	5-6	
closed	closed	open	CC000 ~ CDFFF
*closed	open	closed	D0000 ~ D1FFF
closed	open	open	D4000~ D5FFF
open	closed	closed	D8000 ~ D9FFF
open	closed	open	DC000 ~ DDFFF
open	open	open	OFF

*default setting

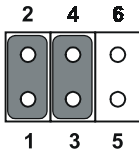

CC000 ~ CDFFF

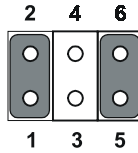

D0000 ~ D1FFF*

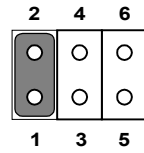

D4000~ D5FFF

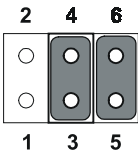

D8000 ~ D9FFF

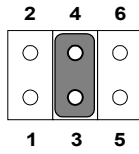

DC000 ~ DDFFF

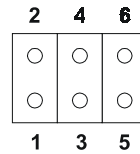

OFF

2.5 Clear CMOS (JP5)

Warning!



To avoid damaging the computer, always **turn off** the power supply before clearing the CMOS. Before turning the power supply back on, return the jumper to “3.0 V Battery On.”

Table 2.5: JP5: Clear CMOS

Pins	Function
1-2	clear CMOS
2-3*	3.0 V battery on

* default setting

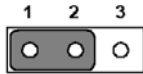

clear CMOS

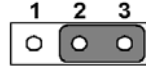

3.0 V battery on*

2.6 Audio Amp Power Select (JP7)

Table 2.6: JP7: Audio amplifier power select

Pins	Function
1-2*	+5V (main power)
2-3	Regulated +5V

* default setting

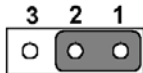

+5V (main power)*

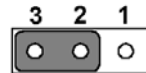

Regulated +5V

2.7 Connectors

Connectors on the board link it to external devices such as hard disk drives, a keyboard or expansion bus connectors.

2.7.1 Connector Locations

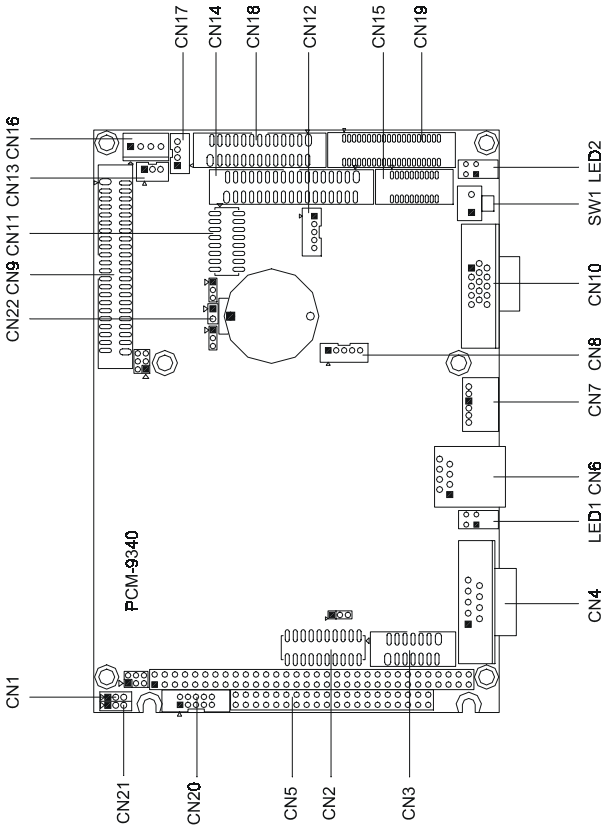

Figure 2.2: Connector Locations

2.7.2 Connector Functions

Label	Function
CN1	CPU fan connector
CN2	COM3/COM4 connector
CN3	COM2 connector
CN4	COM1 connector
CN5	PC/104 connector
CN6	Ethernet connector
CN7	PS/2 keyboard and PS/2 mouse
CN8	IR connector (infrared)
CN9	Hard disk connector
CN10	CRT display connector
CN11	Audio connector (optional)
CN12	Backlight connector
CN13	ATX feature connector
CN14	Floppy disk connector
CN15	Ext. flat panel connector
CN16	Power connector (+5 V, +12 V)
CN17	CD Audio
CN18	Parallel port connector
CN19	Flat panel connector
CN20	GPIO connector
CN21	Aux Power connector (-5 V, -12 V)
CN22	ATX power button
LED1	Ethernet LED
LED2	Power and HDD activity LED
SW1	Reset switch

2.8 Making Connections

The following sections tell how to make each connection. In most cases, you will simply need to connect a standard cable. All of the connector pin assignments are shown in Appendix C.

Warning!



Always completely disconnect the power cord from your chassis whenever you are working on it. Do not make connections while the power is on. Sensitive electronic components can be damaged by a sudden rush of power. Only experienced electronics personnel should open the PC chassis.

Caution!



Always ground yourself to remove any static charge before touching the CPU card. Modern electronic devices are very sensitive to static electric charges. Use a grounding wrist strap at all times. Place all electronic components on a static-dissipative surface or in a static-shielded bag when they are not in the chassis. This is especially important where the ambient air is very dry.

2.9 CPU Fan power supply connector (CN1)

Provides power supply to CPU cooling fan. Only present when +5 V and +12 V power is supplied to the board.

2.10 Serial ports (CN2, CN3, CN4)

The PCM-9340 offers four serial ports: three RS-232 (COM 1, 3, 4) and one RS-232/422/485 (COM 2). These ports allow you to connect to any serial device (a mouse, a printer, etc.) or to a communication network.

2.10.1 COM3/COM4 RS-232 port (CN2)

The COM3/COM4 series port, consists of 20 pin dual-in-line, male header.

2.10.2 COM2 RS-232/422/485 selection (CN3)

This secondary port between CN2 and CN4 consists of a 14-pin, dual-in-line, male header, and can be configured, via JP2 (*q.v.*), to operate in RS-232, RS-422, or RS-485 mode.

The IRQs and address ranges for the COM ports are fixed. However, if you wish to disable a port or change these parameters later, you can do this in the system BIOS setup.

2.10.3 COM1 RS-232 port (CN4)

This serial port connector is the 9-pin D-SUB connector toward the left side.

2.10.4 Share IRQ

The IRQ and the address range for COM1, 2, 3, 4 default are fixed. However, if you wish to disable the port or change these parameters later, you can do this in the system BIOS setup. The table below shows the settings for the PCM-9340's serial ports.

Table 2.8: Serial port default settings

Port	Address range	Interrupt
COM1	3F8 ~ 3FF	IRQ4
COM2	2F8~2FF	IRQ3
COM3	3E8~3EF	IRQ10
COM4	2E8~2EF	IRQ5

COM1-4 can share one IRQ that can be selected in BIOS setup under Windows 98 and Windows NT. Choices are: IRQ3, IRQ4, IRQ5 or IRQ10.

2.11 PC/104 connectors (CN5)

The PCM-9340 is equipped with a 16-bit ISA signal PC/104 connector for future expansion. See Appendix B for details.

2.12 Ethernet Connections (CN6, LED1, LED2)

The PCM-9340 is equipped with a high performance 32-bit PCI Ethernet interface which is fully compliant with IEEE 802.3u 10/100 Mbps CSMA/CD standards. It is supported by all major network operating systems.

The Ethernet medium can be configured via the RSET8139.EXE program included on the utility disk. (See Chapter 5 for detailed information.)

2.12.1 100Base-T RJ-45 connector (CN6)

100Base-T connections are made via the on-board RJ-45 connector.

2.12.2 Network boot

The network boot feature is built into the BIOS. It can be enabled or disabled in the chipset setup of the CMOS configuration. Refer to Chapter 3, “Award BIOS Setup,” for more information.

2.12.3 Ethernet LED and HDD/power LEDs (LED1, LED2)

Ethernet LED (LED1)

Table 2.9: Ethernet LED setup

LED	Setting
Green lamp	Tx
Yellow lamp	Link

LED 1 should be set so that when the cable is connected, the yellow lamp is activated; and when data is transmitted, the green lamp is activated. Note polarity on LEDs.

Power and HDD LED (LED2)

Table 2.10: HDD/power LED setup

LED	Setting
Green lamp	Power
Yellow lamp	HDD

LED 2 should be set so when the HDD is accessed, the yellow lamp is activated; and when the power is on, the green lamp is activated. Polarity is important on LED lamps.

2.13 Keyboard and PS/2 mouse connector (CN7)

The PCM-9340 board provides a keyboard connector. A 6-pin mini-DIN connector (CN7) on the card mounting bracket supports singleboard computer applications. The card comes with an adapter to convert from the 6-pin mini-DIN connector to a standard DIN connector and to a PS/2 mouse connector.

2.14 IR connector (CN8)

This connector supports the optional wireless infrared transmitting and receiving module. This module mounts on the system case. You must configure the setting through BIOS setup.

2.15 Enhanced IDE HDD Connector (CN9)

You can attach two IDE (Integrated Device Electronics) drives to the PCM-9340 internal controller. The PCM-9340 SBC card has an EIDE connector, CN9.

Wire number 1 on the cable is red or blue, and the other wires are gray. Connect one end to connector CN9 on the PCM-9340. Make sure that the red (or blue) wire corresponds to pin 1 on the connector. See Figure 2-1, where pin 1 is indicated with a triangle or a solid square.

Unlike floppy drives, IDE hard drives can connect in either position on the cable. If you install two drives, you will need to set one as the master and one as the slave. You do this by setting the jumpers on the drives. If you use just one drive, you should set it as the master. See the documentation that came with your drive for more information.

Connect the first hard drive to the free end of the cable. Wire 1 on the cable should also connect to pin 1 on the hard drive connector, which should be labeled on the drive circuit board. Check the documentation that came with the drive for more information. If you are using a second drive, connect it to the remaining connector on the same cable.

2.16 VGA interface connections (CN10, CN15, CN19)

The PCM-9340's PCI SVGA interface can drive conventional CRT displays and is capable of driving a wide range of flat panel displays, including passive and active LCD displays. The board has two connectors to support these displays, one for standard CRT VGA monitors and one for flat panel displays.

2.16.1 CRT display connector (CN10)

CN10 is a 16-pin, dual-inline header used for conventional CRT displays. A simple one-to-one adapter can be used to match CN10 to a standard 15-pin D-SUB connector commonly used for VGA.

Pin assignments for CRT display connector CN18 are detailed in Appendix C.

2.16.2 Extension flat panel connector (CN15)

CN15 consists of a 20-pin connector which is Hirose's product no. DF13A-20DP-1.25V. The PCM-9340 supports a 36-bit LCD panel which must be connected to both the CN19 (40-pin) and the CN15 (20-pin). The pin assignments for both CN19 and the CN15 can be found in Appendix C.

2.16.3 Flat panel display connector (CN19)

CN19 consists of a 40-pin connector which can support a 24-bit LCD panel. It is Hirose's product no. DF13A-40DP-1.25 V

The PCM-9340 provides a bias control signal on CN19 that can be used to control the LCD bias voltage. It is recommended that the LCD bias voltage not be applied to the panel until the logic supply voltage (+5 V or +3.3 V) and panel video signals are stable. Under normal operation, the control signal (ENAVEE) is active high. When the PCM-9340's power is applied, the control signal is low until just after the relevant flat panel signals are present.

2.17 Audio interfaces (CN11, CN17) (optional)

The PCM-9340 is equipped with a high-quality audio interface, which provides 16-bit CD-quality recording and playback as well as OPL3 compatible FM music. It is supported by all major operating systems.

2.17.1 Audio connector (CN11)

The PCM-9340 provides all major audio signals on a 16-pin flat-cable connector, CN11. These audio signals include Microphone in (mono), Line in (stereo), Line out (stereo), and Speaker out (stereo). If you use traditional telephone jack connectors for these audio signals, you will need an adapter cable.

2.17.2 CD audio input connector (CN17)

Any CD-ROM drive can provide analog audio signal output when used as a music CD player. The CN17 on PCM-9340 is a connector to input CD audio signals into the audio controller. The audio cable of your CD-ROM drive will be used to connect to CN17.

2.17.3 Audio power source setting (JP7)

The PCM-9340 is designed to work with a single +5 V power supply. The audio interface can also function normally under single +5V power supply, but most audio controllers require an independent power source generated from a +12 V power supply. The independent power source avoids the noise from the other digital circuits. The PCM-9340's audio interface

can accept +12 V power to provide improved quality audio. This is done via JP7.)

Table 2.11: JP7: Audio Power Source Setting

Pins	Function
1-2*	+5V (main power)
2-3	Regulated +5V

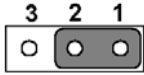

+5V (main power)*

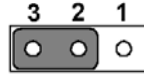

Regulated +5V

* default setting

Configuration of the audio interface may be done entirely via the software utility. You do not have to set any jumpers if you don't want to. Refer to Chapter 6 for audio setup details.

2.18 ATX power (CN13, CN16, CN22)

The PCM-9340 supports an advanced soft power switch function, if an ATX power supply is used.

Important *Make sure that the ATX power supply can take at least a 10 mA load on the 5 V standby lead (5VSB). If not, you may have difficulty powering on your system.*

To enable the soft power switch function, get the specially designed ATX-to-EBX power cable (PCM-9340 optional item, part no. 1703200201).

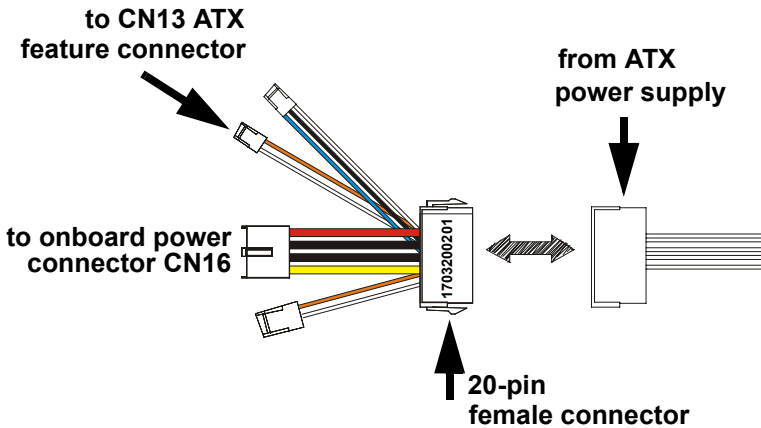

Figure 2.3: Wiring for ATX feature power

Connect the ATX female end to the ATX connector from the power supply.

2.18.1 ATX feature connector (CN13)

Connect the tiny 2-wire plug to CN13 (ATX feature connector).

2.18.2 Board Main Power (CN16)

Connect the 4-wire plug to CN16.

2.18.3 ATX soft power switch (CN22)

Connect the power on/off button to CN22. (A momentary button switch should be used.)

2.19 FDD connector (CN14)

You can attach up to two floppy disk drives to the PCM-9340's onboard controller. You can use any combination of 5.25" (360 KB/1.2 MB) and/or 3.5" (720 KB/1.44/2.88 MB) drives.

The card comes with a 34-pin daisy-chain drive connector cable. On one end of the cable is a 34-pin flat-cable connector. On the other end are two sets of floppy disk drive connectors. Each set consists of a 34-pin flat-cable connector (usually used for 3.5" drives) and a printed-circuit-board connector (usually used for 5.25" drives). You can use only one connector in each set. The set on the end (after the twist in the cable) connects to the A: floppy. The set in the middle connects to the B: floppy.

2.20 Parallel port connector (CN18)

The parallel port is designated as LPT1, and is normally used to connect the CPU card to a printer. The PCM-9340 includes an on-board parallel port, accessed through a 26-pin flat-cable connector, CN18. The card comes with an adapter cable which lets you use a traditional DB-25 connector. The cable has a 26-pin connector on one end and a DB-25 connector on the other, mounted on a retaining bracket. The bracket installs at the end of an empty slot in your chassis, giving you access to the connector.

To install the bracket, find an empty slot in your chassis. Unscrew the plate that covers the end of the slot. Screw in the bracket in place of the plate. Next, attach the flat-cable connector to CN18 on the CPU card. Wire 1 of the cable is red or blue, and the other wires are gray. Make sure that wire 1 corresponds to pin 1 of CN18. Pin 1 is on the right side of CN18.

2.21 General Purpose Input Output (CN20)

The PCM-9340 supports 8-bit GPIO through CN20. The 8 digital in- and out-puts can be programmed to read or control devices, with input or output defined. The default setting is 4 bits input and 4 bits output.

CHAPTER 3

Award BIOS Setup

This chapter describes how to set BIOS configuration data.

Chapter 3 Award BIOS Setup

3.1 System test and initialization

These routines test and initialize board hardware. If the routines encounter an error during the tests, you will either hear a few short beeps or see an error message on the screen. There are two kinds of errors: fatal and non-fatal. The system can usually continue the boot up sequence with non-fatal errors. Non-fatal error messages usually appear on the screen along with the following instruction:

press <F1> to RESUME

Write down the message and press the F1 key to continue the bootup sequence.

3.1.1 System configuration verification

These routines check the current system configuration against the values stored in the board's CMOS memory. If they do not match, the program outputs an error message. You will then need to run the BIOS setup program to set the configuration information in memory.

There are three situations in which you will need to change the CMOS settings:

1. You are starting your system for the first time
2. You have changed the hardware attached to your system
3. The CMOS memory has lost power and the configuration information has been erased.

The PCM-9340 Series' CMOS memory has an integral lithium battery backup. The battery backup should last ten years in normal service, but when it finally runs down, you will need to replace the complete unit.

3.2 Award BIOS setup

Award's BIOS ROM has a built-in Setup program that allows users to modify the basic system configuration. This type of information is stored in battery-backed CMOS RAM so that it retains the Setup information when the power is turned off.

3.2.1 Entering setup

Power on the computer and press immediately. This will allow you to enter Setup.

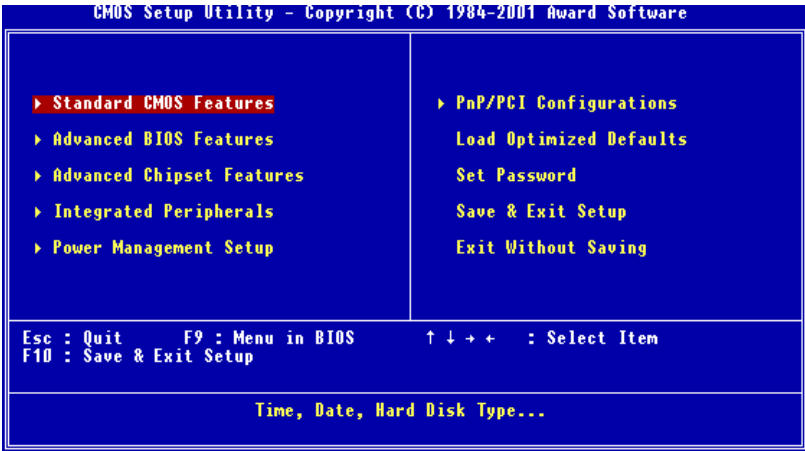

Figure 3.1: BIOS setup program initial screen

3.2.2 Standard CMOS Features setup

When you choose the Standard CMOS Features option from the Initial Setup Screen menu, the screen shown below is displayed. This standard Setup Menu allows users to configure system components such as date, time, hard disk drive, floppy drive and display. Once a field is highlighted, on-line help information is displayed in the left bottom of the Menu screen.

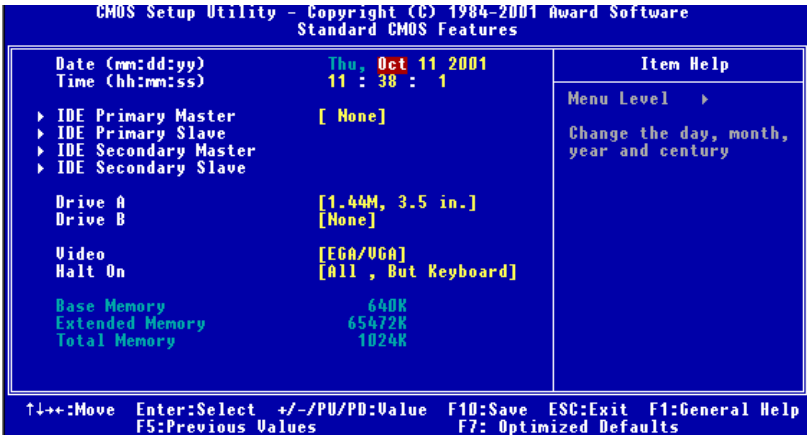

Figure 3.2: CMOS Features setup

3.2.3 Advanced BIOS Features setup

By choosing the Advanced BIOS Features Setup option from the Initial Setup Screen menu, the screen below is displayed. This sample screen contains the manufacturer's default values for the PCM-9340 Series.

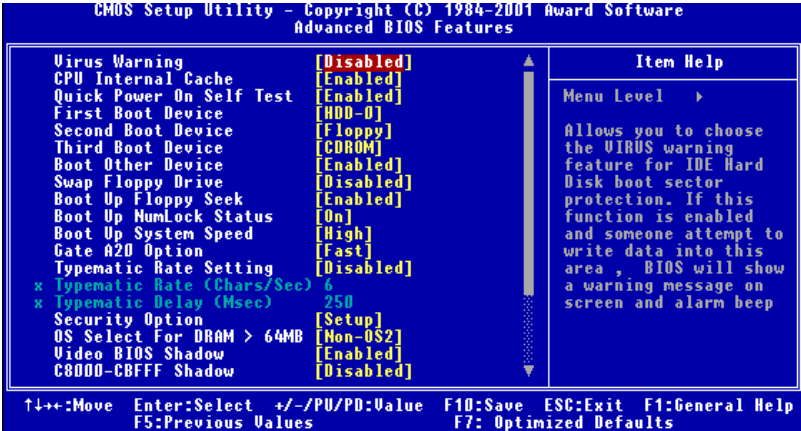

Figure 3.3: Advanced BIOS Features setup

3.2.4 Advanced Chipset Features setup

By choosing the Advanced Chipset Features option from the Initial Setup Screen menu, the screen below is displayed. This sample screen contains the manufacturer's default values for the PCM-9340 Series.

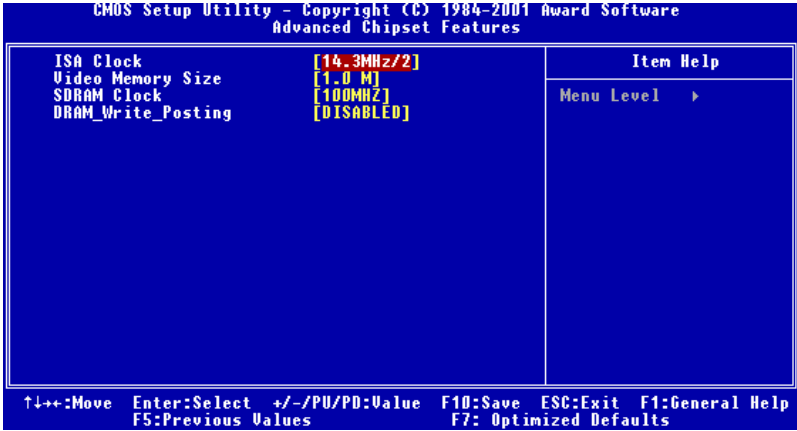

Figure 3.4: Advanced Chipset Features setup

3.2.5 Integrated Peripherals

Choosing the Integrated Peripherals option from the Initial Setup Screen menu should produce the screen below. Here we see the manufacturer's default values for the PCM-9340 Series. The PANEL TYPE by default supports a 18-bit 640 x 480 TFT LCD panel display.

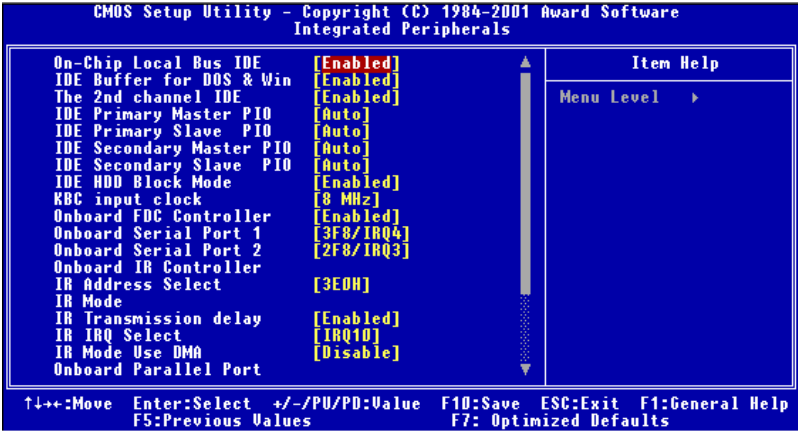

Figure 3.5: Integrated Peripherals

3.2.6 Power Management Setup

By choosing the Power Management Setup option from the Initial Setup Screen menu, the screen below is displayed. This sample screen contains the manufacturer's default values for the PCM-9340 Series.

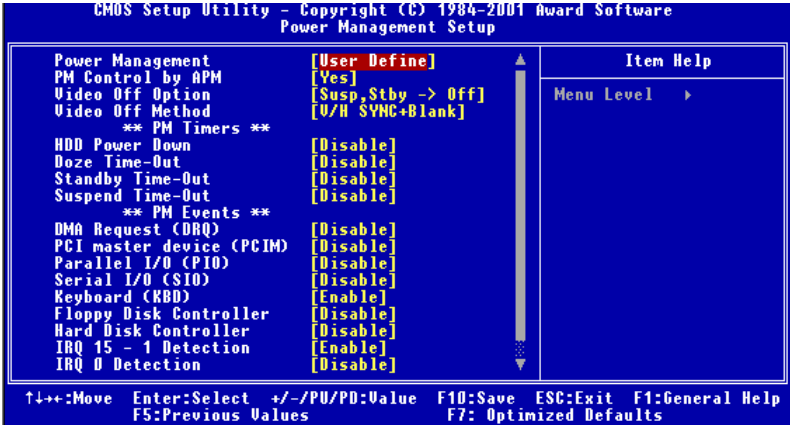

Figure 3.6: Power Management Setup

3.2.7 PnP/PCI Configurations

By choosing the PnP/PCI Configurations option from the Initial Setup Screen menu, the screen below is displayed. This sample screen contains the manufacturer's default values for the PCM-9340 Series.

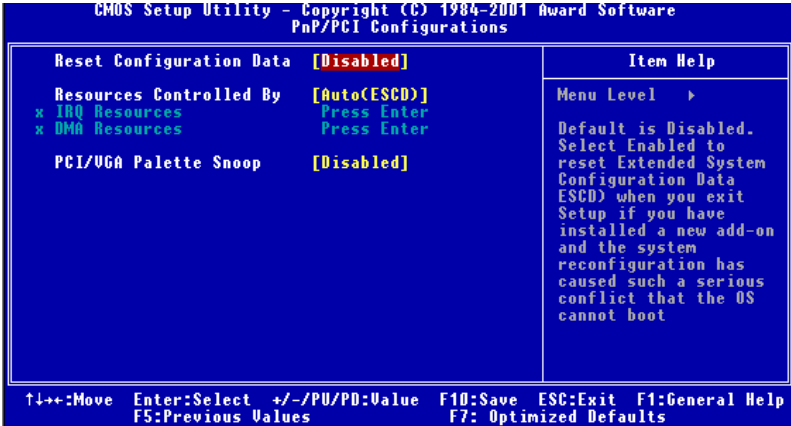

Figure 3.7: PnP/PCI Configurations

3.2.8 Load Optimized Defaults

Load Optimized Defaults loads the default system values directly from ROM. If the stored record created by the Setup program should ever become corrupted (and therefore unusable), these defaults will load automatically when you turn the PCM-9340 Series system on.

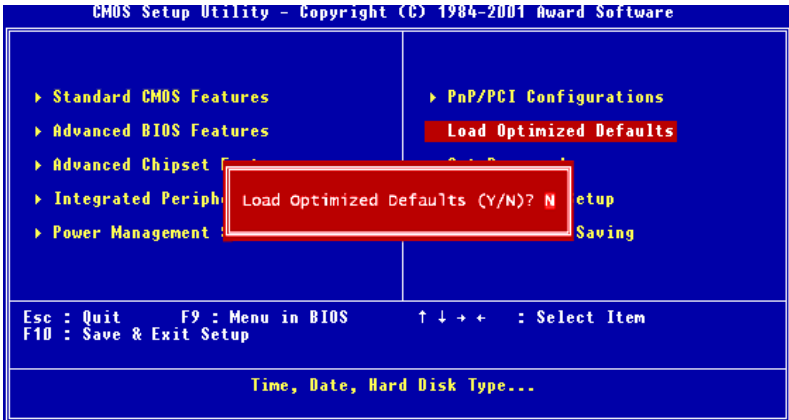

Figure 3.8: Load BIOS defaults screen

3.2.9 Set Password

Note *To enable this feature, you should first go to the Advanced BIOS Features menu, choose the Security Option, and select either Setup or System, depending on which aspect you want password protected. Setup requires a password only to enter Setup. System requires the password either to enter Setup or to boot the system.*

A password may be at most 8 characters long.

To Establish Password

1. Choose the Set Password option from the CMOS Setup Utility main menu and press <Enter>.
2. When you see “Enter Password,” enter the desired password and press <Enter>.

3. At the “Confirm Password” prompt, retype the desired password, then press <Enter>.
4. Select Save to CMOS and EXIT, type <Y>, then <Enter>.

To Change Password

1. Choose the Set Password option from the CMOS Setup Utility main menu and press <Enter>.
2. When you see “Enter Password,” enter the existing password and press <Enter>.
3. You will see “Confirm Password.” Type it again, and hit <Enter>.
4. Select Set Password again, and at the “Enter Password” prompt, enter the new password and press <Enter>.
5. At the “Confirm Password” prompt, retype the new password, and press <Enter>.
6. Select Save to CMOS and EXIT, type <Y>, then <Enter>.

To Disable Password

1. Choose the Set Password option from the CMOS Setup Utility main menu and press <Enter>.
 2. When you see “Enter Password,” enter the existing password and press <Enter>.
 3. You will see “Confirm Password.” Type it again, and hit <Enter>.
 4. Select Set Password again, and at the “Enter Password” prompt, don’t enter anything; just press <Enter>.
 5. At the “Confirm Password” prompt, again don’t type in anything; just press <Enter>.
- Select Save to CMOS and EXIT, type <Y>, then <Enter>.

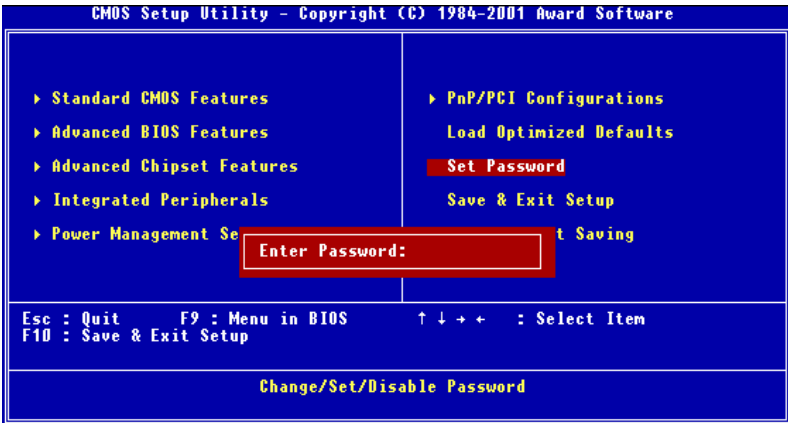

Figure 3.9: Set Password

3.2.10 Save & Exit Setup

If you select this option and press <Y> then <Enter>, the values entered in the setup utilities will be recorded in the chipset's CMOS memory. The microprocessor checks this every time you turn your system on and uses the settings to configure the system. This record is required for the system to operate.

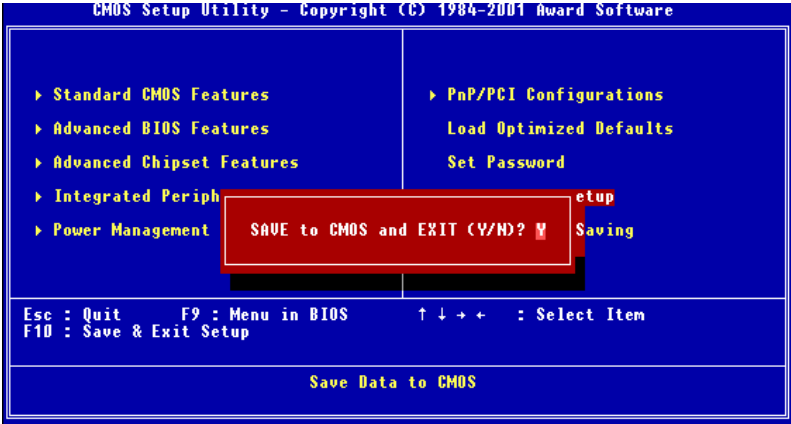

Figure 3.10: Save and Exit Setup

3.2.11 Exit Without Saving

Selecting this option and pressing <Enter> lets you exit the Setup program without recording any new values or changing old ones.

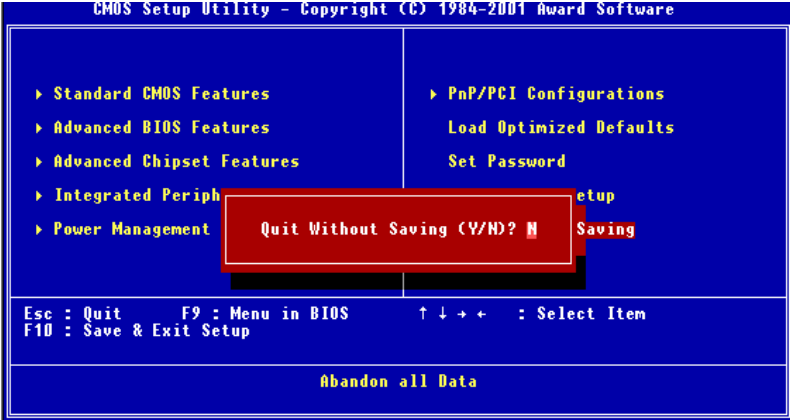

Figure 3.11: Exit without Saving

CHAPTER 4

SVGA Setup

- Introduction
- Installation of SVGA drivers
-for Windows 95/98/NT

Chapter 4 PCI SVGA Setup

4.1 Introduction

The PCM-9340 has an on-board LCD/VGA interface. The specifications and features are described as follows:

4.1.1 Chipset

The PCM-9340 uses a SMI LynxEM+ 712G chipset for its SVGA controller. It supports many popular 18-bit LCD displays and conventional analog CRT monitors. The VGA BIOS supports LCD. In addition, it also supports interlaced and non-interlaced analog monitors (color and monochrome VGA) in high-resolution modes while maintaining complete IBM VGA compatibility. Digital monitors (i.e. MDA, CGA, and EGA) are NOT supported. Multiple frequency (multisync) monitors are handled as if they were analog monitors.

4.1.2 Display memory

With 2MB shared memory, the VGA controller can drive CRT displays or color panel displays with resolutions up to 1280 x 1024 at 256 colors.

4.2 Installation of the SVGA Driver

Complete the following steps to install the SVGA driver.

Notes:

- 1. The windows illustrations in this chapter are intended as examples only. Please follow the listed steps, and pay attention to the instructions which appear on your screen.*
- 2. For convenience, the CD-ROM drive is designated as "D" throughout this chapter.*
- 3. When you are using a CRT display, please make sure that your resolution settings (in the BIOS setup) are the same as your VGA resolution settings (in Windows). Otherwise your display may behave strangely.*

4.2.1 Installation for Windows 95

1. In the Windows 95 Main screen, click on "Start," select "Settings," then "Control Panel." Double click the "Display" icon.



2. Select the "Settings" tab, then click the "Advanced Properties" button.

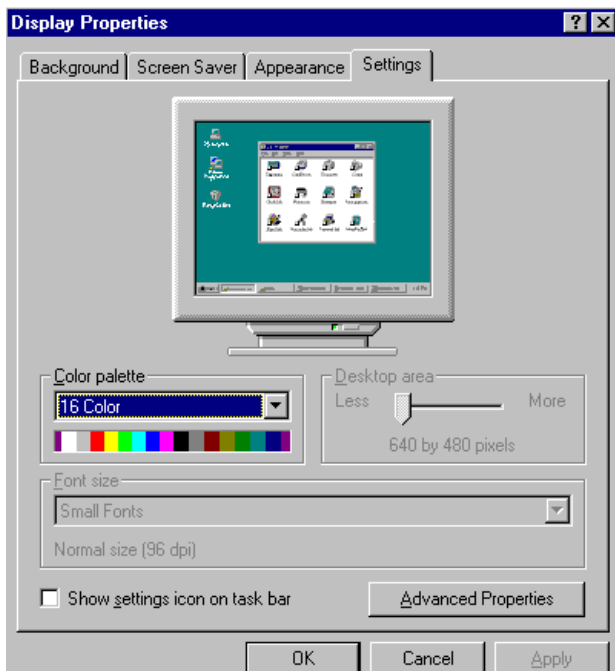

3. Choose the "Adapter" tab, then press the "Change..." button.

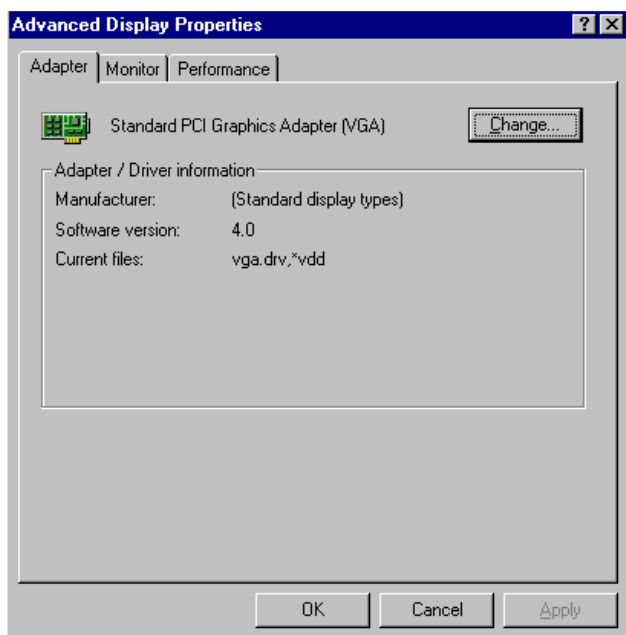

4. Press the "Have Disk" button.

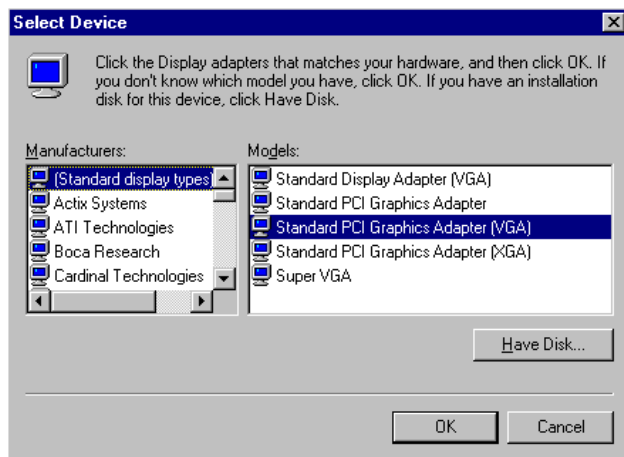

5. Direct the path to the SMI VGA driver in the CD and click "OK" to install the driver.



6. Select the highlighted item, and click the "OK" button.

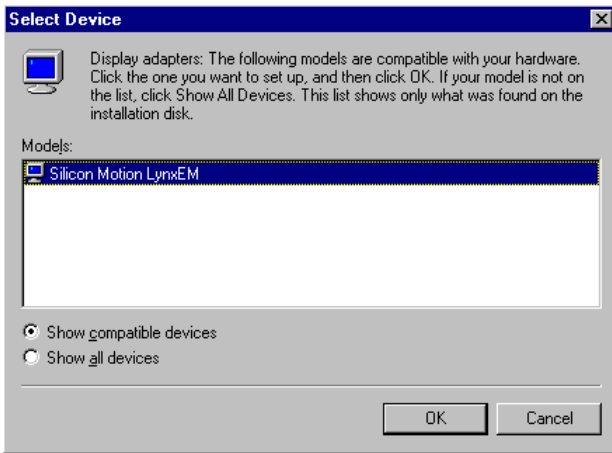

7. “Silicon Motion LynxEM” appears under the adapter tab. Click the “Apply” button, then the “OK” button.

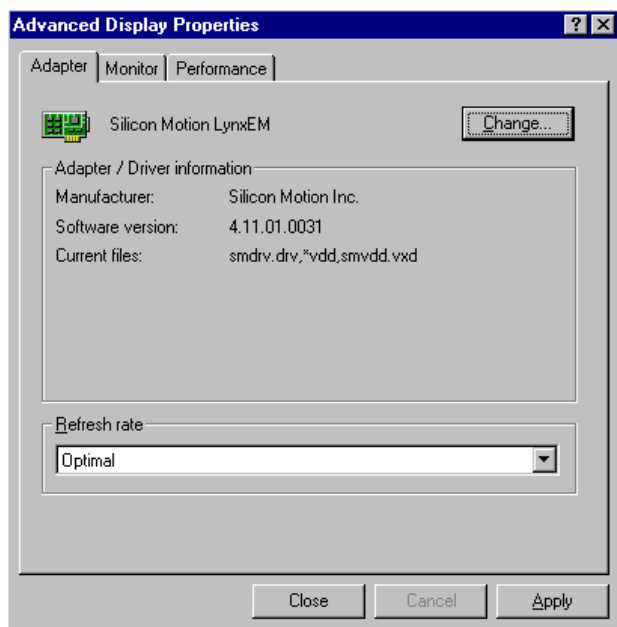

8. Press “Yes” to reboot.

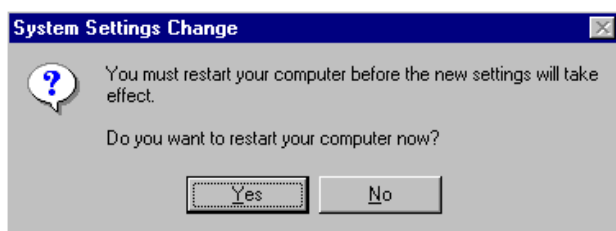

4.2.2 Installation for Windows 98

1. Select "Start", "Settings", "Control Panel", double click "Display", press "Settings," then press the "Advanced..." button.

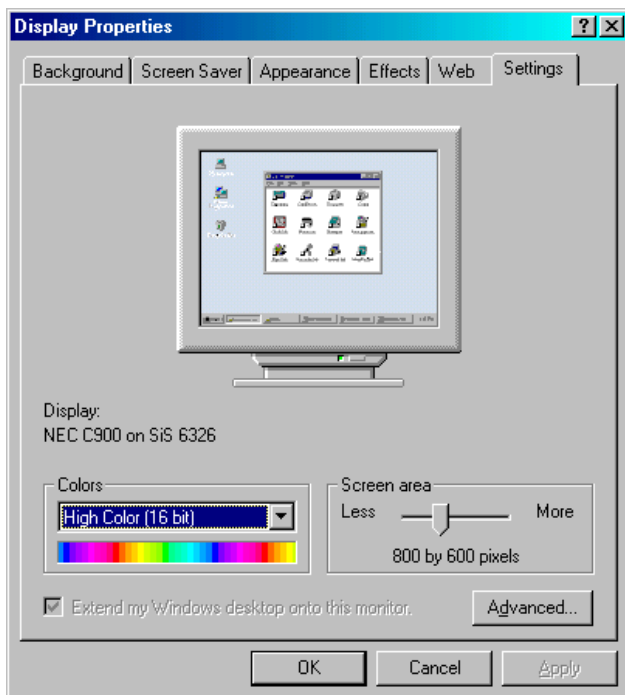

2. Select “Adapter,” then “Change.”

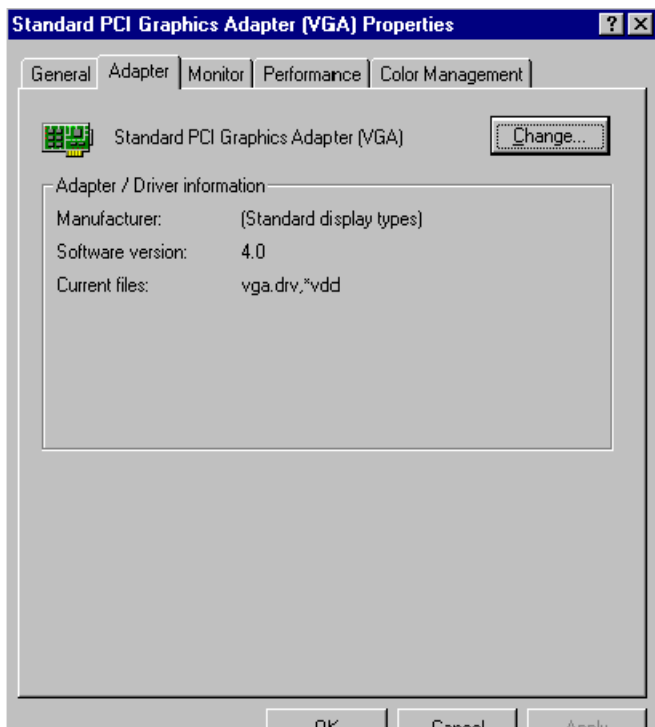

3. Select “Display a list of all...” and press “Next.”



4. Press the “Have disk...” button.

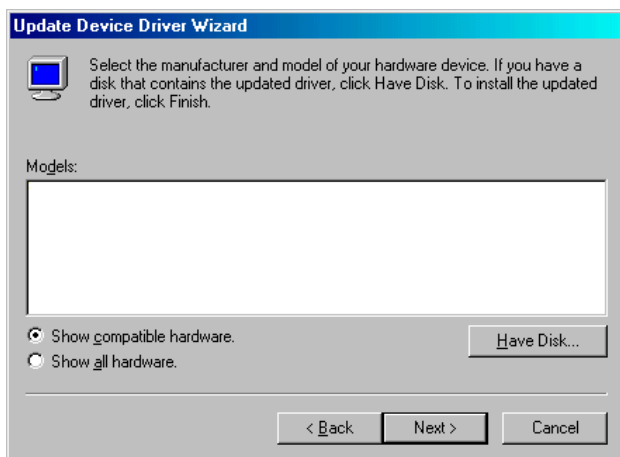

5. Insert the CD into the CD-ROM drive. Type in the path to the CD-ROM, then press “OK”



6. Select the highlighted item, then click “OK.”

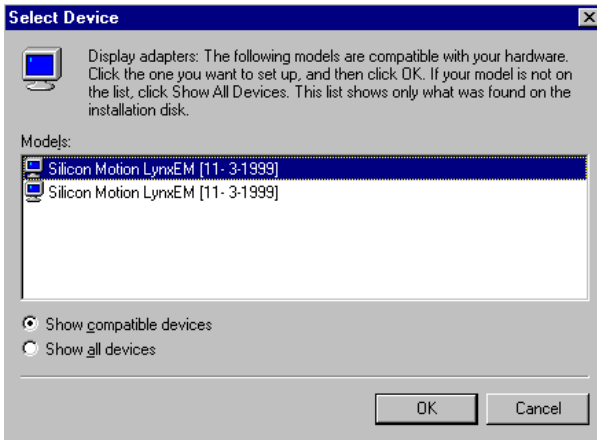

7. "Silicon Motion LynxEM" appears under the adapter tab. Click the "Apply" button.

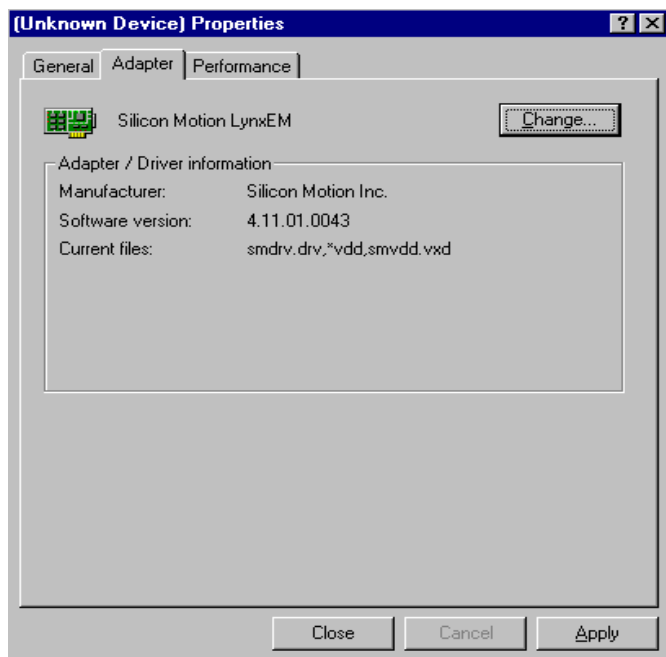

8. Press "Yes" to reboot.

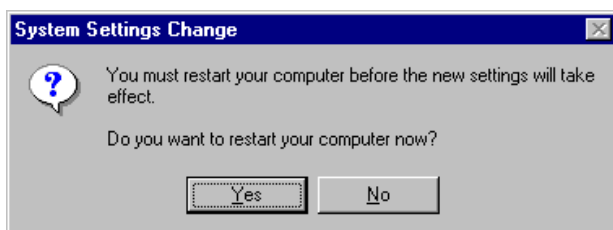

4.2.3 Installation for Windows NT

1. Select "Start", "Settings", "Control Panel" and double click the "Display" icon.

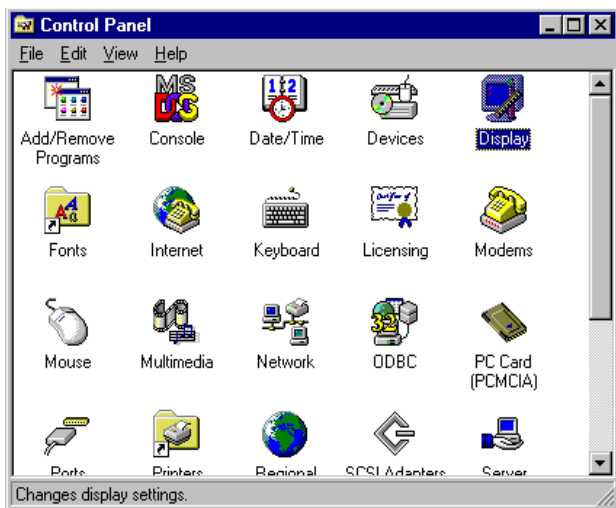

2. Choose the "Settings" tab, and press the "Display Type" button.

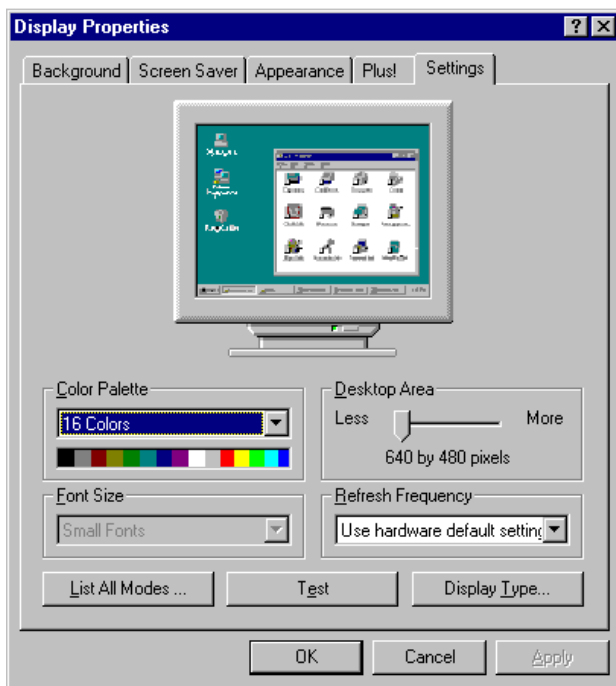

3. Press the "Change..." button.

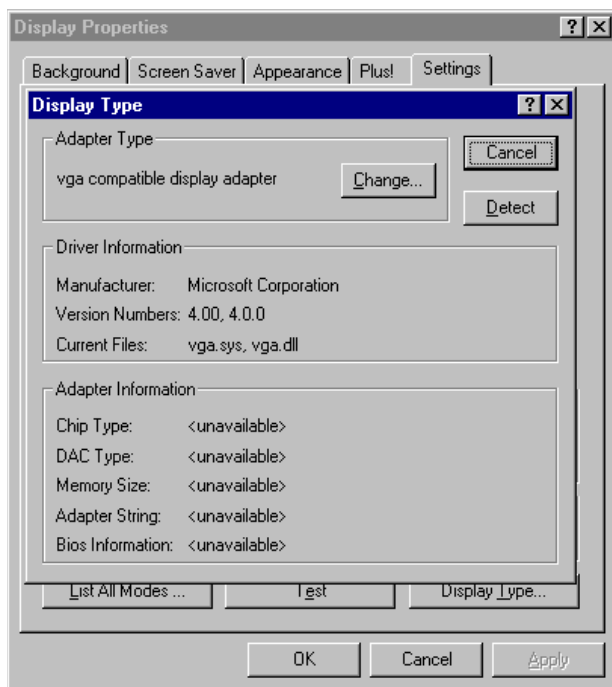

4. Click the "Have Disk..." button.

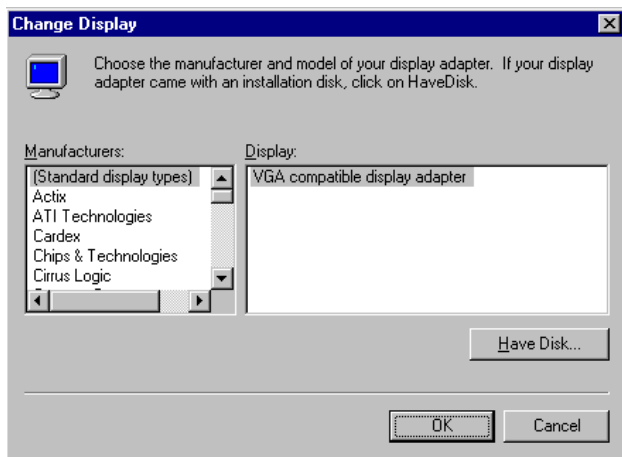

5. Type the path to the CD-ROM, and press the "OK" button.



6. Select the highlighted item, and click the "OK" button.

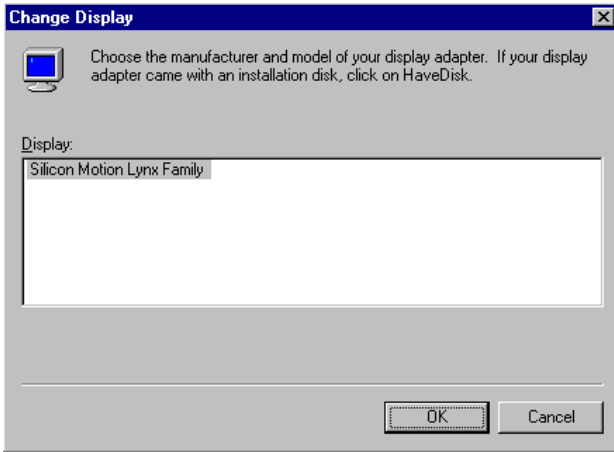

7. Press "Yes" to proceed.

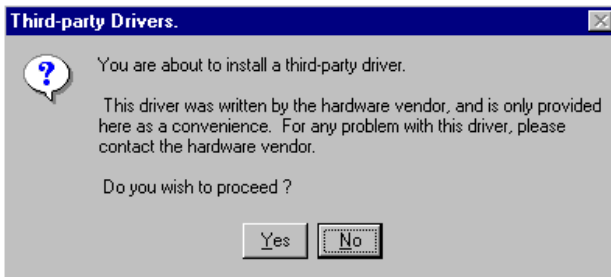

8. Press "OK" to reboot.

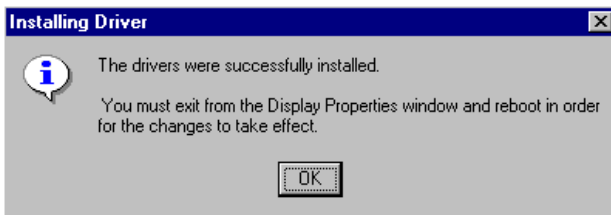

4.3 Further Information

For further information about the AGP/SVGA installation in your PCM-9340, including driver updates, troubleshooting guides and FAQ lists, visit the following web resources:

VIA website: www.via.com.tw

EMAC website: www.emacinc.com

PCI Bus Ethernet Interface

This chapter provides information on
Ethernet configuration.

Introduction

Installation of Ethernet drivers for
Windows 95/98/NT

Further information

Chapter 5 PCI Bus Ethernet Interface

5.1 Introduction

The PCM-9340 is equipped with a high performance 32-bit Ethernet chipset which is fully compliant with IEEE 802.3 100 Mbps CSMA/CD standards. It is supported by major network operating systems. It is also both 100Base-T and 10Base-T compatible. The medium type can be configured via the RSET8139.exe program included on the utility disk.

The Ethernet port provides a standard RJ-45 jack onboard (CN6). The network boot feature can be utilized by incorporating the boot ROM image files for the appropriate network operating system. The boot ROM BIOS files are combined with system BIOS, which can be enabled/disabled in the BIOS setup.

5.2 Ethernet Driver Installation

Before installing the Ethernet driver, note the procedures below. You must know which operating system you are using in your PCM-9340 Series, and then refer to the corresponding installation steps. You will quickly and successfully complete the installation, even if you are not familiar with instructions for MS-DOS or Windows.

Note: *The windows illustrations in this chapter are examples only. Follow the steps and pay attention to the instructions which appear on your screen.*

5.2.1 Installation for Windows 95

1.
 - a. Select "Start", "Settings", "Control Panel"
 - b. Double click "System".

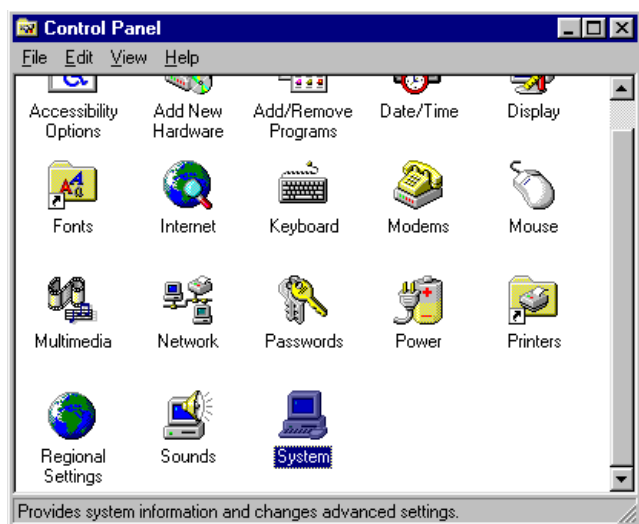

2. Click "Device Manager" folder, then double click "PCI Ethernet Controller."

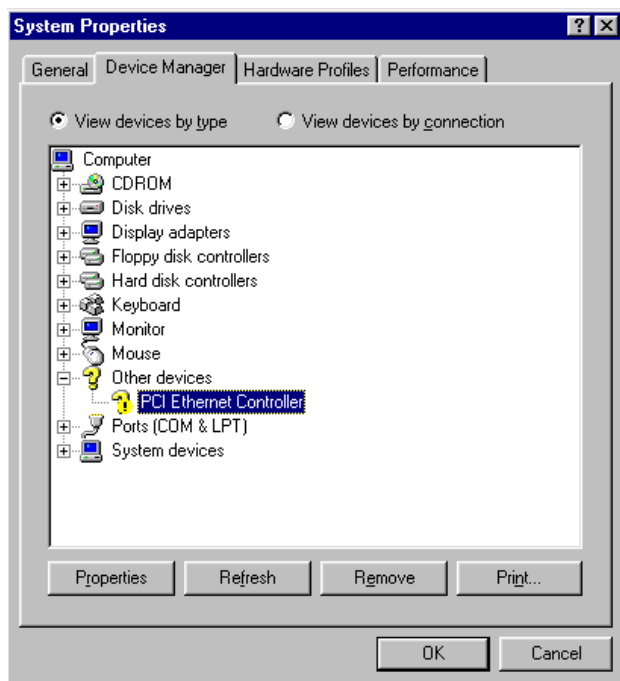

3. Select the "Driver" tab, then click "Update Driver ..."



4. Select "No, select driver from list," and click the "NEXT" button.



5. Highlight "Network Adapters" then click the "NEXT" button.

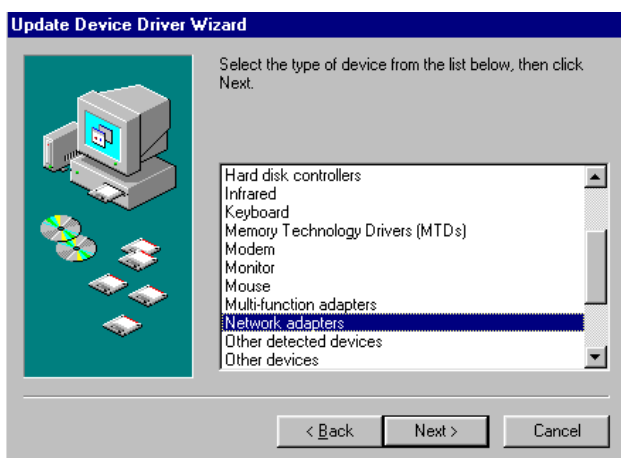

- Click "Have Disk..." to update the LAN driver.

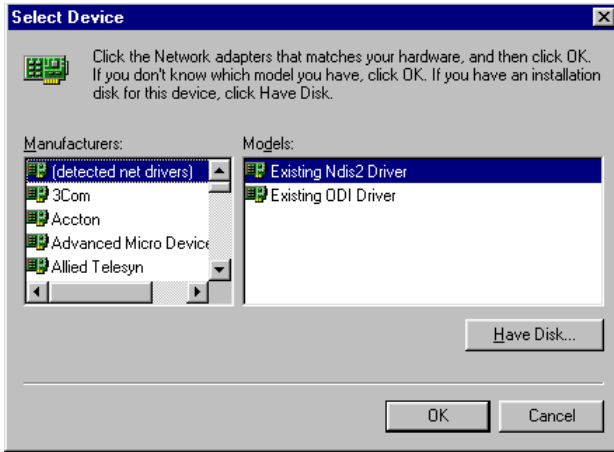

- Direct the path to the LAN driver to install it.

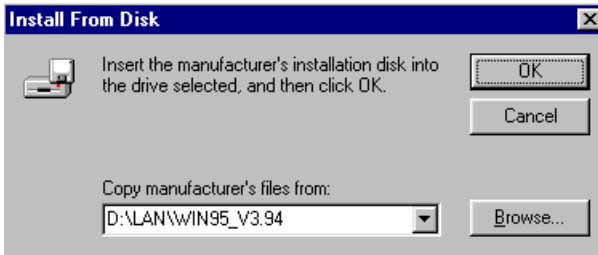

- Insert the Windows 95 CD and click "OK."

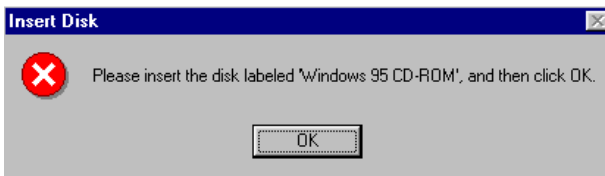

9. Reboot the system.

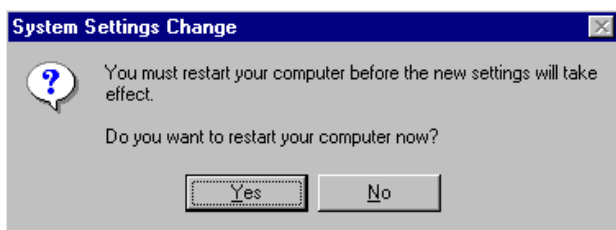

5.2.2 Installation for Windows 98

1.
 - a. Select "Start", "Settings", "Control Panel".
 - b. Double click on the "System" icon.



2. Click the "Device Manager" tab, then highlight "PCI Ethernet Controller"

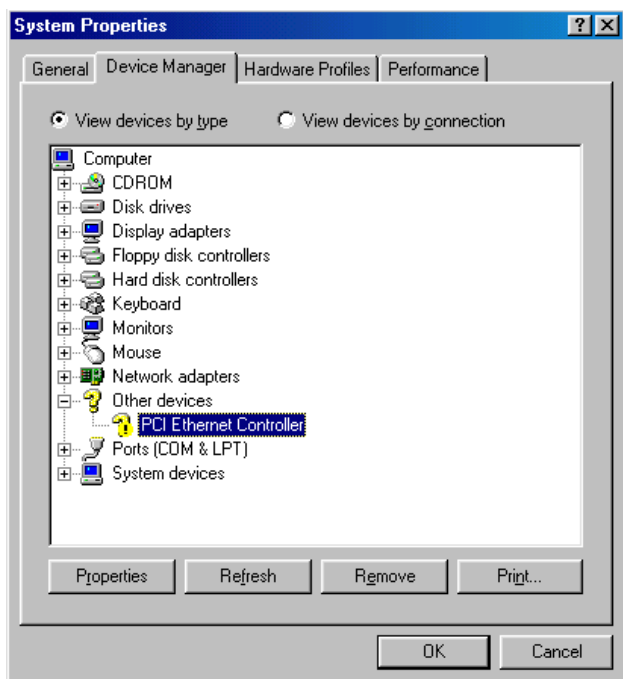

3. Click on "Properties," select the "Driver" tab, then "Update Driver..."



4. Select "Display a list of all the...." then hit "NEXT."

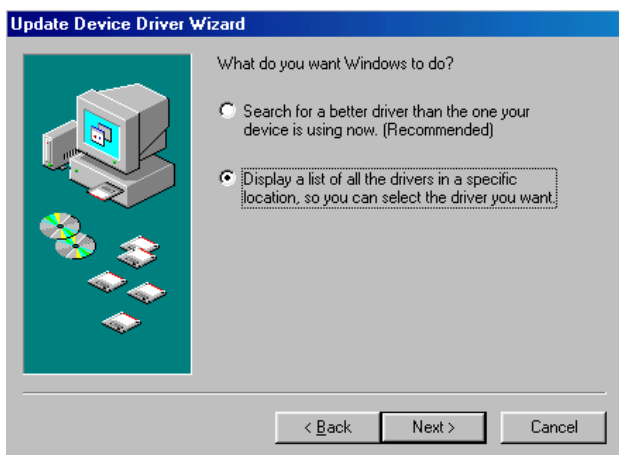

5. Select "Network adapters," and click the "NEXT" button.

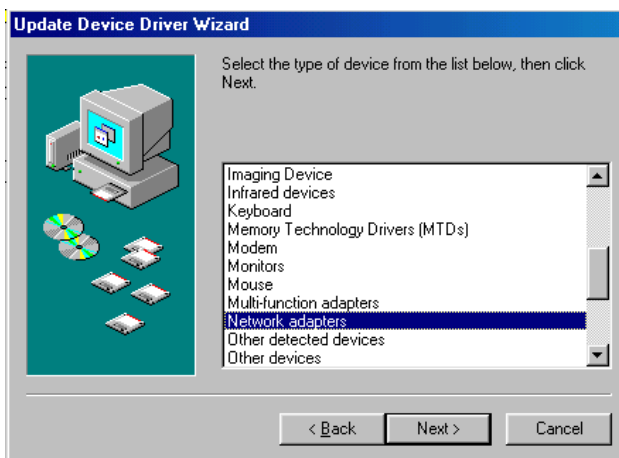

6. Click the "Have Disk..." button.

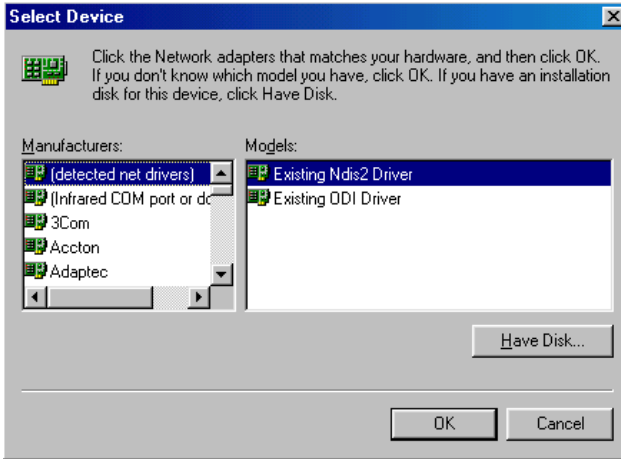

7.
 - a. Insert the CD ROM.
 - b. Type "D:\LAN\WIN98_V3.94" (where D: represents your CDROM drive).
 - c. Click "OK".

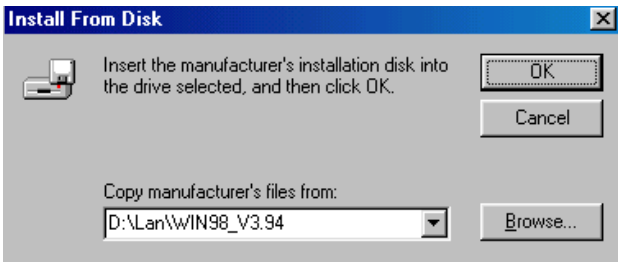

8. The system will now install the driver.

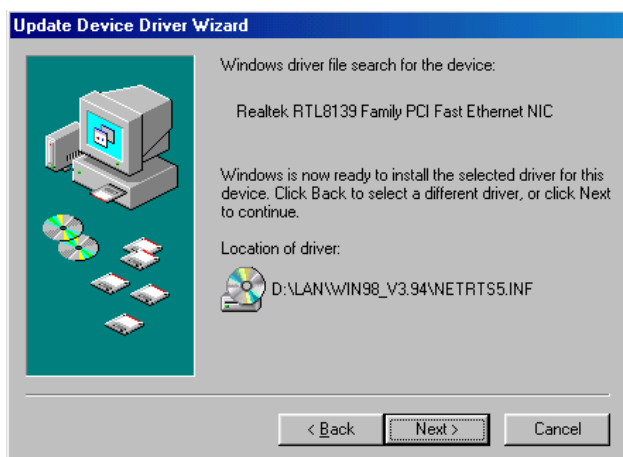

9. Insert the Windows 98 CD in the CDROM drive.

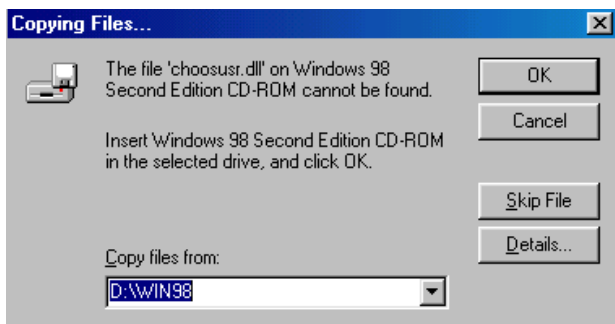

10. Reboot the system.

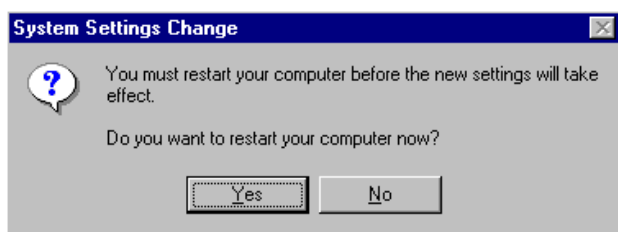

5.2.3 Installation for Windows NT

1. a. Select "Start," "Settings," and "Control Panel."
b. Double click "Network".

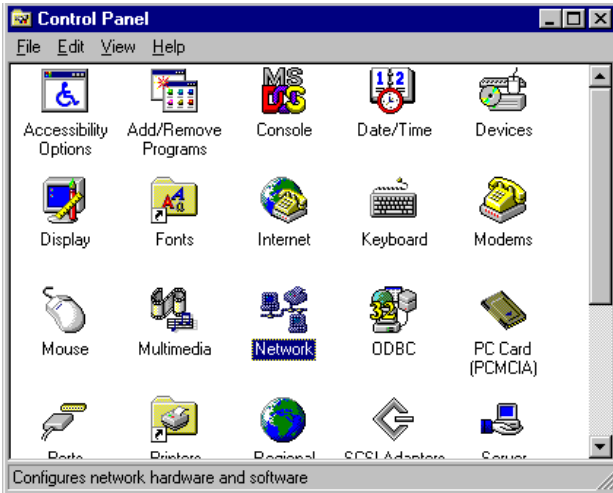

2. Click on "Select from list."

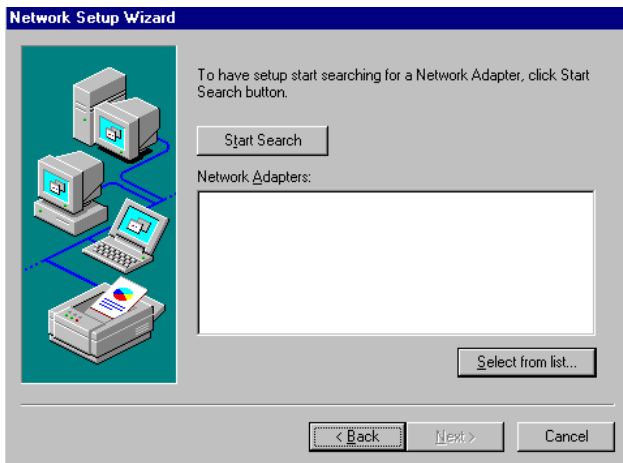

3. Click "Have Disk..."

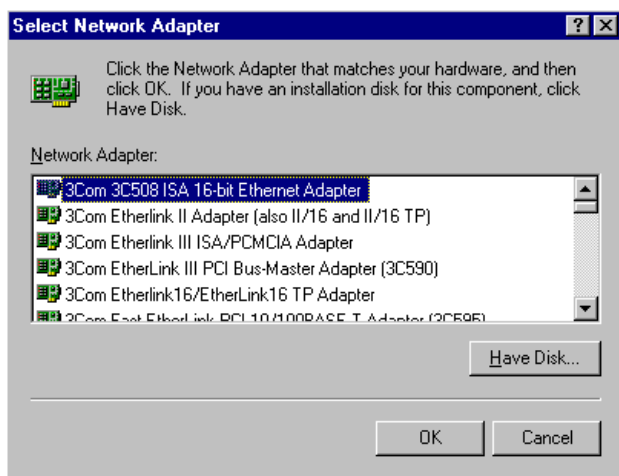

4. Type in the path, then click "OK."

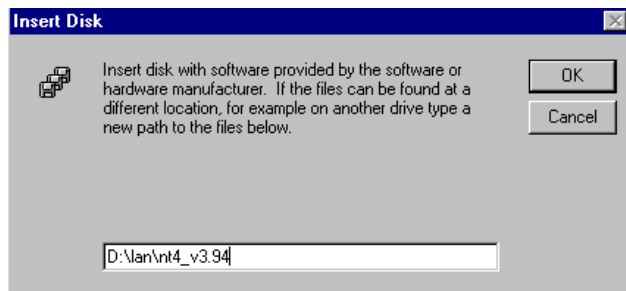

5. Insert the Windows NT CD.

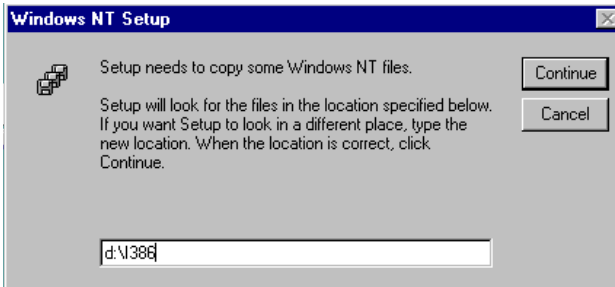

6. Reboot.

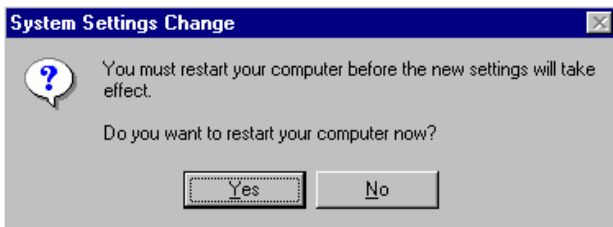

5.3 Further information

Realtek website: www.realtek.com.tw

EMAC website: www.emacinc.com

CHAPTER 6

Audio Setup

The PCM-9340 is equipped with an audio interface that records and plays back CD-quality audio. This chapter provides instructions for installing the software drivers for Windows 95/98/NT

Chapter 6 Audio Setup

6.1 Introduction

The PCM-9340 on-board audio interface provides high-quality stereo sound and FM music synthesis (ESFM) by using the ES1373 audio controller from Creative Technology Ltd. The audio interface can record, compress, and play back voice, sound, and music with a built-in mixer control. The PCM-9340's on-board audio interface also supports the Plug and Play (PnP) standard and provides PnP configuration for audio, FM, and MPU-104 logical devices. It is compatible with AC97 version 2.0, voice, and music functions. The ESFM synthesizer is register compatible with the OPL3 and has extended capabilities.

6.2 Audio Driver Installation

Before installing the audio driver, please take note of the procedures detailed below. You must know which operating system you are using in your PCM-9340, and then refer to the corresponding installation flow chart. Just follow the steps in the flow chart. You can quickly and successfully complete the installation, even though you are not familiar with instructions for Windows.

Notes:

1. *The CD-ROM drive is designated as "D" throughout this chapter.*

2. *For Windows 98, in step 1 the path is:*

D:/Biscuit/9340/audio/Win98/setup.exe.

For Windows 2000, in step 1 the path is:

D:/Biscuit/9340/audio/win2k/setup.exe.

For Windows NT, in step 1 the path is:

D:/Biscuit/9340/audio/winnt/setup.exe.

6.2.1 Installation for Windows 95/98/NT

1.
 - a. Select "Start", "Run"
 - b. Type in the correct path
D:\Biscuit\9340\Audio\Winxx\
D:\biscuit\9340\audio\Win95\
D:\biscuit\9340\audio\Win95
 - c. Click the "OK" button.

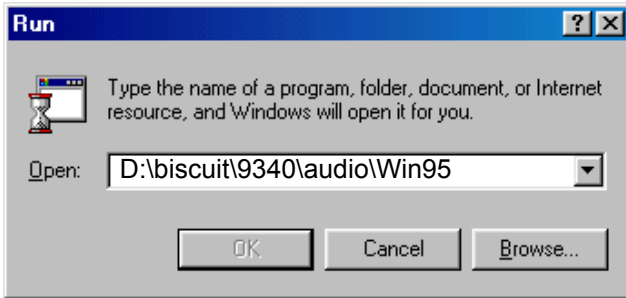

2.
 - a. Click "Yes" to accept the agreement.
 - b. On the next page, read the Readme file, then click "Next."

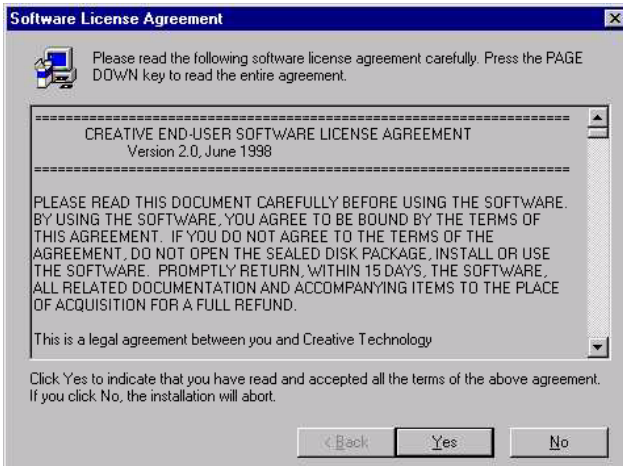

3. a. Click "Next" to continue
b. Follow the procedure which appears on your screen.



4. After installation, select "Yes" and click "Finish" to restart the computer.



Programming the Watchdog Timer

The PCM-9340 is equipped with a watchdog timer that resets the CPU or generates an interrupt if processing comes to a standstill for any reason. This feature ensures system reliability in industrial standalone or unmanned environments.

Appendix A Programming the Watchdog Timer

A.1 Supported Input Timing Modes

In order to program the watchdog timer, you must write a program which writes I/O port address 443 (hex). The output data is a value of time interval. The value range is from 01 (hex) to 3E (hex), and the related time interval is 1 sec. to 62 sec.

Data	Time Interval
01	1 sec.
02	2 sec.
03	3 sec.
04	4 sec.
	.
	.
	.
3E	62 sec.

After data entry, your program must refresh the watchdog timer by rewriting the I/O port 443 (hex) while simultaneously setting it. When you want to disable the watchdog timer, your program should read I/O port 443 (hex).

The following example shows how you might program the watchdog timer in BASIC:

```
10      REM Watchdog timer example program
20      OUT &H443, data  REM Start and restart the
      watchdog
30      GOSUB 1000  REM Your application task #1
40      OUT &H443, data  REM Reset the timer
50      GOSUB 2000  REM Your application task #2
60      OUT &H443, data  REM Reset the timer
70      X=INP (&H443)  REM Disable the watchdog timer
80      END

1000   REM  Subroutine #1, your application task
      .
      .
      .
1070   RETURN
2000   REM  Subroutine #2, your application task
      .
      .
      .
2090   RETURN
```

Appendix **B**

Installing PC/104 Modules

This appendix gives instructions for installing PC/104 modules.

Appendix B Installing PC/104 Modules

B.1 Installing PC/104 Modules

The PCM-9340's PC/104 connectors give you the flexibility to attach PC/104 modules.

Installing these modules on the PCM-9340 is quick and simple. The following steps show to mount the PC/104 modules:

1. Remove the PCM-9340 from your system, paying particular attention to the safety instructions mentioned previously.
2. Make any jumper or link changes required to the biscuit SBC now. Once the PC/104 module is mounted, you may have difficulty in accessing these.
3. Normal PC/104 modules have male connectors and mount directly onto the main card. (Refer to the diagram on the following page.)
4. Mount the PC/104 module onto the biscuit SBC by pressing the module firmly but carefully onto the mounting connectors.
5. Secure the PC/104 module onto the biscuit SBC using the four mounting spacers and screws.

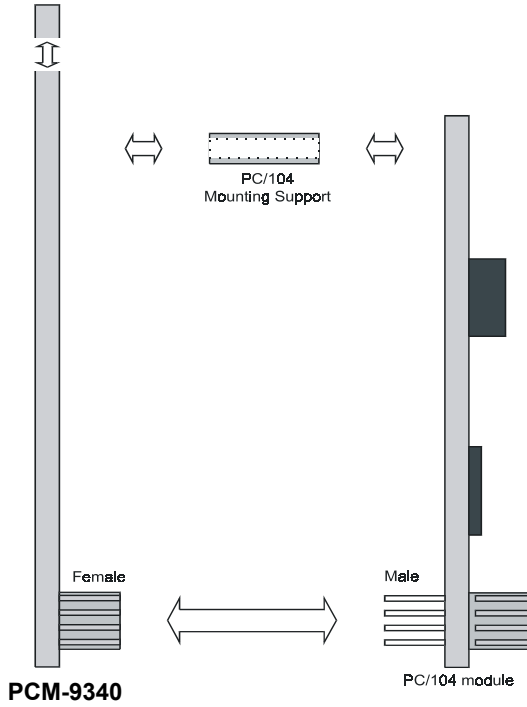

Figure B.1: PC/104 module mounting diagram

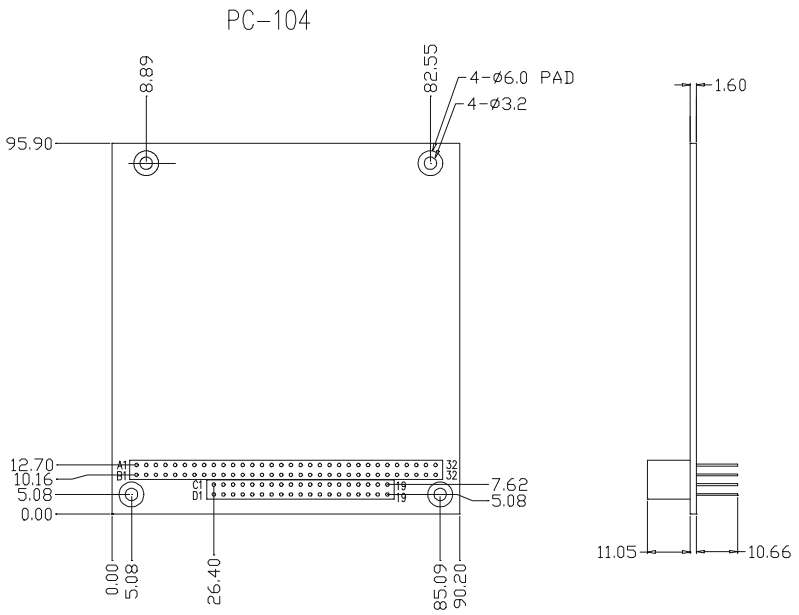

Figure B.2: PC/104 module dimensions (mm) (± 0.1)

Pin Assignments

This appendix contains information of a detailed or specialized nature. It includes:

- CPU Fan connector
- COM3/COM4 connector
- COM2 connector
- COM1 connector
- Ethernet connector
- PS/2 Keyboard PS/2 Mouse connector
- IR connector
- IDE hard drive connector
- CRT display connector
- Audio connector (optional)
- Backlight connector
- ATX feature connector
- Floppy disk connector
- Ext. flat panel connector
- Main power connector (+5 V, +12 V)
- CD Audio in
- Parallel port connector
- Flat panel connector
- GPIO connector
- Auxiliary power connector (-5 V, -12 V)
- ATX power button

Appendix C Pin Assignments

C.1 CPU fan power connector (CN1)

Table C.1: CPU fan power connector (CN1)

Pin	Signal
1	+5V
2	GND
3	+12V



C.2 COM 3, COM 4 connector (CN2)

Table C.2: COM Port Connector (CN2)

Pin	Signal	Pin	Signal
1	RLSD1 (DCD1)	2	DSR1
3	RX1	4	RTS1
5	TX1	6	CTS1
7	DTR1	8	RI1
9	GND	10	GND
11	RLSD2 (DCD2)	12	DSR2
13	RX2	14	RTS2
15	TX2	16	CTS2
17	DTR2	18	RI2
19	GND	20	GND

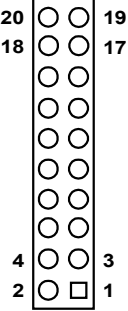

C.3 COM 2 connector (CN3)

Table C.3: COM2 RS-232/422/485 series port (CN3)

Pin	RS-232 port	RS-422 port	RS-485 port
1	DCD	N/C	N/C
2	DSR	N/C	N/C
3	RxD	N/C	N/C
4	RTS	N/C	N/C
5	TxD	N/C	N/C
6	CTS	N/C	N/C
7	DTR	N/C	N/C
8	RI	N/C	N/C
9	GND	N/C	N/C
10	N/C	N/C	N/C
11	N/C	TxD+	DATA+
12	N/C	TxD-	DATA-
13	N/C	RxD+	N/C
14	N/C	RxD-	N/C

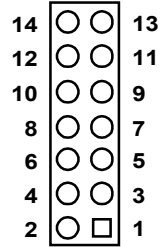

C.4 COM 1 RS-232 connector (CN4)

Table C.4: COM1 RS-232 connector

Pin	Signal
1	DCD
2	RXD
3	TXD
4	DTR
5	GND
6	DSR
7	RTS
8	CTS
9	RI

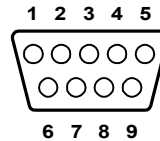

C.5 PC/104 Connector (CN5)

CN5 (ISA bus long side)

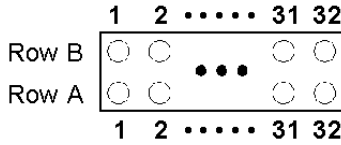

CN5 (ISA bus short side)

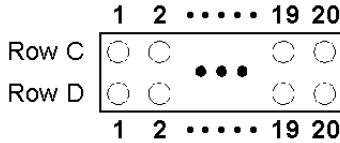

Table C.5: PC/104 connectors (CN5)

Pin	Signal			
Number	Row A	Row B	Row C	Row D
0	—	—	0V	0 V
1	IOCHCHK*	0 V	SBHE*	MEMCS16*
2	SD7	RESETDRV	LA23	IOCS16*
3	SD6	+5 V	LA22	IRQ10
4	SD5	IRQ9	LA21	IRQ11
5	SD4	-5 V	LA20	IRQ12
6	SD3	DRQ2	LA19	IRQ15
7	SD2	-12 V	LA18	IRQ14
8	SD1	ENDXFR*	LA17	DACK0*
9	SD0	+12 V	MEMR*	DRQ0
10	IOCHRDY	N/C	MEMW*	DACK5*
11	AEN	SMEMW*	SD8	DRQ5
12	SA19	SMEMR*	SD9	DACK6*
13	SA18	IOW*	SD10	DRQ6
14	SA17	IOR*	SD11	DACK7*
15	SA16	DACK3*	SD12	DRQ7
16	SA15	DRQ3	SD13	+5 V
17	SA14	DACK1*	SD14	MASTER*
18	SA13	DRQ1	SD15	0 V
19	SA12	REFRESH*	KEY	0 V

Table C.5: PC/104 connectors (CN5)

Pin Number	Signal			
	Row A	Row B	Row C	Row D
20	SA11	SYSCLK	—	—
21	SA10	IRQ7	—	—
22	SA9	IRQ6	—	—
23	SA8	IRQ5	—	—
24	SA7	IRQ4	—	—
25	SA6	IRQ3	—	—
26	SA5	DACK2*	—	—
27	SA4	TC	—	—
28	SA3	BALE	—	—
29	SA2	+5 V	—	—
30	SA1	OSC	—	—
31	SA0	0 V	—	—
32	0 V	0 V	—	—

* active low

C.6 Ethernet 10/100Base-T Connector (CN6)

Table C.6: Ethernet 10/100Base-T connector (CN6)

Pin	Signal
1	XMT+
2	XMT-
3	RCV+
4	N/C
5	N/C
6	RCV-
7	N/C
8	N/C

C.7 Keyboard and PS/2 Mouse Connector (CN7)

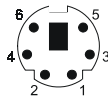



Table C.7: Keyboard and mouse connector (CN7)

Pin	Signal
1	KB DATA
2	MS DATA
3	GND
4	Vcc (+5V)
5	KB CLOCK
6	MS CLOCK

C.8 IR Connector (CN8)

Table C.8: IR Connector (CN8)

Pin	Signal
1	VCC (+5 V)
2	N.C.
3	IR receive
4	GND
5	IR transmit



C.9 IDE Hard Drive Connector (CN9)

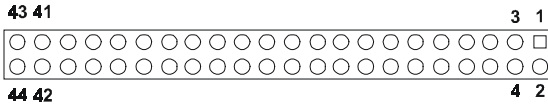

Table C.9: IDE HDD connector (CN9)

Pin	Signal	Pin	Signal
1	IDE RESET*	2	GND
3	DATA 7	4	DATA 8
5	DATA 6	6	DATA 9
7	DATA 5	8	DATA 10
9	DATA 4	10	DATA 11
11	DATA 3	12	DATA 12
13	DATA 2	14	DATA 13
15	DATA 1	16	DATA 14
17	DATA 0	18	DATA 15
19	SIGNAL GND	20	N/C
21	HDD 0	22	GND
23	IO WRITE	24	GND
25	IO READ	26	GND
27	HD READY	28	N/C
29	HDACK 0*	30	GND
31	IRQ14	32	N/C
33	ADDR 1	34	N/C
35	ADDR 0	36	ADDR 2
37	HARD DISK SELECT 0*	38	HARD DISK SELECT 1*
39	IDE ACTIVE*	40	GND
41	VCC	42	VCC
43	GND	44	N/C

* low active

C.10 CRT Display Connector (CN10)

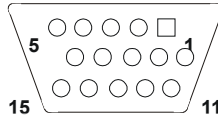

Table C.10: CRT Display Connector (CN10)

Pin	Signal	Pin	Signal
1	RED	9	VGA G
2	+5 V	10	H-sync signal
3	GREEN	11	VGA G
4	VGA G	12	V-sync signal
5	BLUE	13	VGA G
6	N/C	14	VGA CK
7	N/C	15	VGA G
8	VGA Data		

C.11 Audio Connector (optional) (CN11)

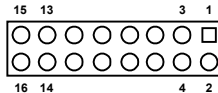

Table C.11: Audio connector (CN11)

Pin	Signal	Pin	Signal
1	SPEAKER OUT R+	2	SPEAKER OUT R-
3	SPEAKER OUT L+	4	SPEAKER OUT L-
5	LINE OUT R	6	LINE OUT L
7	GND	8	GND
9	LINE IN R	10	LINE IN L
11	GND	12	GND
13	NC	14	NC
15	MIC IN	16	GND

C.12 LCD Inverter Backlight Connector (CN12)

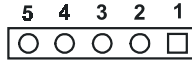

Table C.12: Backlight Connector (CN12)

Pin	Signal
1	+12 V
2	GND
3	Backlight on/off control
4	Backlight VR control
5	+5 V

C.13 ATX Power Feature Connector (CN13)

Table C.13: ATX Power Feature Connector (CN13)

Pin	Signal
1	5VSB (Stand by voltage)
2	GND
3	PS. ON#

Diagram showing the pin configuration for the ATX Power Feature Connector (CN13). The pins are labeled 3, 2, 1 from bottom to top. Pin 1 is represented by a square, and pins 2 and 3 are represented by circles.

C.14 Floppy Disk Drive Connector (CN14)

Table C.14: Floppy Disk Drive Connector (CN14)			
Pin	Signal	Pin	Signal
1	GND	2	DENSITY SELECT*
3	GND	4	N/C
5	GND	6	DRIVE TYPE
7	GND	8	INDEX*
9	GND	10	MOTOR 0*
11	GND	12	DRIVE SELECT 1*
13	GND	14	DRIVE SELECT 0*
14	GND	16	MOTOR 1*
17	GND	18	DIRECTION*
19	GND	20	STEP*
21	GND	22	WRITE DATA*
23	GND	24	WRITE GATE*
25	GND	26	TRACK 0*
27	GND	28	WRITE PROTECT*
29	GND	30	READ DATA*
31	GND	32	HEAD SELECT*
33	GND	34	DISK CHANGE*

*low active

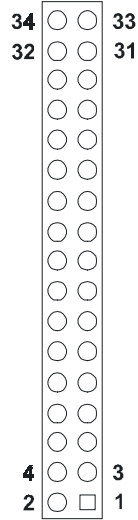

C.15 Extended Flat Panel Display Connector (CN15)

Table C.15: Extended Flat Panel Display Connector (CN15)

Pin	Signal	Pin	Signal
1	GND	2	GND
3	P24	4	P25
5	P26	6	P27
7	P28	8	P29
9	P30	10	P31
11	P32	12	P33
13	P34	14	P35
15	GND	16	GND
17	N/C	18	N/C
19	N/C	20	N/C

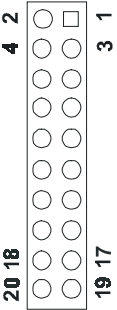

Note: *The model number of the CN15 socket is DF13A-20DP-1.25V (Hirose Electric Co., Ltd.)*

C.16 Main Power Connector (CN16)

Table C.16: Main Power Connector (CN16)

Pin	Signal
1	+12 V
2	GND
3	GND
4	+5 V



C.17 CD audio connector (CN17)

Table C.17: CD audio connector (CN17)

Pin	Signal
1	CD audio control L
2	GND
3	CD audio control R
4	GND



C.18 Parallel Port Connector (CN18)

Table C.18: Parallel Port Connector (CN18)

Pin	Signal	Pin	Signal
1	STROBE*	2	AUTOFD*
3	D0	4	ERR
5	D1	6	INIT*
7	D2	8	SLCTINI*
9	D3	10	GND
11	D4	12	GND
13	D5	14	GND
15	D6	16	GND
17	D7	18	GND
19	ACK*	20	GND
21	BUSY	22	GND
23	PE	24	GND
25	SLCT	26	GND

* low active

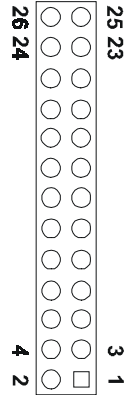

C.19 Flat Panel Connector (CN19)

Table C.19: Flat panel display connector (CN19)

Pin	Signal	Pin	Signal
1	+12 V	2	+12 V
3	GND	4	GND
5	VDD	6	VDD
7	ENAVEE	8	GND
9	P0	10	P1
11	P2	12	P3
13	P4	14	P5
15	P6	16	P7
17	P8	18	P9
19	P10	20	P11
21	P12	22	P13
23	P14	24	P15
25	P16	26	P17
27	P18	28	P19
29	P20	30	P21
31	P22	32	P23
33	GND	34	GND
35	SFK	36	FLM
37	DE (M)	38	LP
39	GND	40	ENABKL

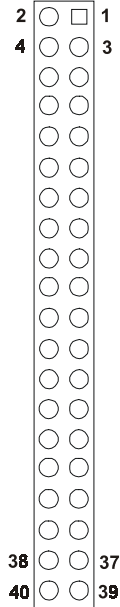

Note 1: The model number of the CN19 connector is DF13A-40DP-1.25V (Hirose Electric Co., Ltd.).

Note 2: The model number of the CN15 connector is DF13A-20DP-1.25V (Hirose Electric Co., Ltd.).

C.20 General Purpose Input Output (CN20)

Table C.20: GPIO connector (CN20)

Pin	Signal
1	GPIO bit 1
2	GPIO bit 5
3	GPIO bit 2
4	GPIO bit 6
5	GPIO bit 3
6	GPIO bit 7
7	GPIO bit 4
8	GPIO bit 8
9	NC
10	NC

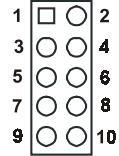

Default: Bit 1~bit 4 set to output; bit 5~bit 8 set to input.

C.21 Auxiliary power connector (CN21)

Table C.21: Aux Power Connector (CN21)

Pin	Signal
1	- 12 V
2	GND
3	- 5 V



C.22 ATX Power Button (CN22)

Table C.22: ATX Power Button (CN22)

Pin	Signal
1	power
2	GND



C.23 Reset Button Connector (SW1)

Table C.23: Reset Button Connector (SW1)

Pin	Signal
1	Reset signal input
2	GND



Appendix **D**

System Assignments

This appendix contains information of a detailed nature. It includes:

- System I/O ports
- DMA channel assignments
- Interrupt assignments
- 1st MB memory map

Appendix D System Assignments

D.1 System I/O Ports

Addr. range (Hex)	Device
000-01F	DMA controller
020-021	Interrupt controller 1, master
022-023	Chipset address
040-05F	8254 timer
060-06F	8042 (keyboard controller)
070-07F	Real-time clock, non-maskable interrupt (NMI) mask
080-09F	DMA page register,
0A0-0BF	Interrupt controller 2
0C0-0DF	DMA controller
0F0	Clear math co-processor
0F1	Reset math co-processor
0F8-0FF	Math co-processor
170-178	2nd fixed disk for CompactFlash
1F0-1F8	1st fixed disk
200-207	Game I/O
278-27F	Reserved
2E8-2EF	Series port 4
2F8-2FF	Serial port 2
300-31F	Ethernet**
360-36F	Reserved
378-37F	Parallel printer port 1 (LPT2)
380-38F	SDLC, bisynchronous 2
3A0-3AF	Bisynchronous 1
3B0-3BF	Monochrome display and printer adapter (LPT1)
3E8-3EF	Series port 3
3C0-3CF	Reserved
3D0-3DF	Color/graphics monitor adapter
3F0-3F7	Diskette controller
3F8-3FF	Serial port 1
443	Watchdog timer

** default setting

D.2 DMA channel assignments

Channel	Function
0	Available
1	Audio*
2	Floppy disk (8-bit transfer)
3	Parallel**
4	Cascade for DMA controller 1
5	Audio*
6	Available
7	Available

* Audio DMA default setting: DMA 1, 5

Audio High DMA select: DMA 1, 3

Audio Low DMA select: DMA 5, 6, 7

** Parallel port DMA default setting: DMA 3

Parallel port DMA select: DMA 1, 3

D.3 Interrupt assignments

Interrupt#	Interrupt source
NMI	Parity error detected
IRQ 0	Interval timer
IRQ 1	Keyboard
IRQ 2	Interrupt from controller 2 (cascade)
IRQ 8	Real-time clock
IRQ 9	Reserve
IRQ 10	Serial communication port 3*
IRQ 11	Reserved for watchdog timer
IRQ 12	PS/2 mouse
IRQ 13	INT from co-processor
IRQ 14	Preliminary IDE
IRQ 15	Secondary IDE for CompactFlash
IRQ 3	Serial communication port 2
IRQ 4	Serial communication port 1
IRQ 5	Serial communication port 4*
IRQ 6	Diskette controller (FDC)
IRQ 7	Parallel port 1 (print port)

*If optional Audio function is enabled, its default setting is IRQ5, Serial communication 4 can share IRQ10 with serial communication port 3

Note: USB and Ethernet IRQs are automatically set by the system

D.4 1st MB memory map

Addr. range (Hex)	Device
F000h - FFFFh	System ROM
E000 - EFFF	Unused
CC00 - DFFF	available
C800 - CBFF*	Ethernet ROM
C000h - C7FFh	VGA BIOS
B800h - BFFFh	CGA/EGA/VGA text
B000h - B7FFh	Reserved for graphic mode usage
A000h - AFFFh	EGA/VGA graphics
0000h - 9FFFh	Base memory

*default setting

D.5 DMA channel assignments

Channel	Function
0	Available
1	Available (audio)
2	Floppy disk (8-bit transfer)
3	Available (parallel port)
4	Cascade for DMA controller 1
5	Available
6	Available
7	Available

* Audio DMA select 1, 3, or 5

** Parallel port DMA select 1 (LPT2) or 3 (LPT1)

D.6 Interrupt assignments

Interrupt#	Interrupt source
IRQ 0	Interval timer
IRQ 1	Keyboard
IRQ 2	Interrupt from controller 2 (cascade)
IRQ 3	COM2
IRQ 4	COM1
IRQ 5	COM4
IRQ 6	FDD
IRQ 7	LPT1
IRQ 8	RTC
IRQ 9	Reserved (audio)
IRQ 10	COM3
IRQ 11	Reserved for watchdog timer
IRQ 12	PS/2 mouse
IRQ 13	INT from co-processor
IRQ 14	Primary IDE
IRQ 15	Secondary IDE for CFC

* Ethernet interface IRQ select: 9, 11, 15

* PNP audio IRQ select: 9, 11, 15

* PNP USB IRQ select: 9, 11, 15

* PNP ACPI IRQ select: 9, 11, 15

Appendix **E**

Mechanical Drawings

E.1 Mechanical Drawings

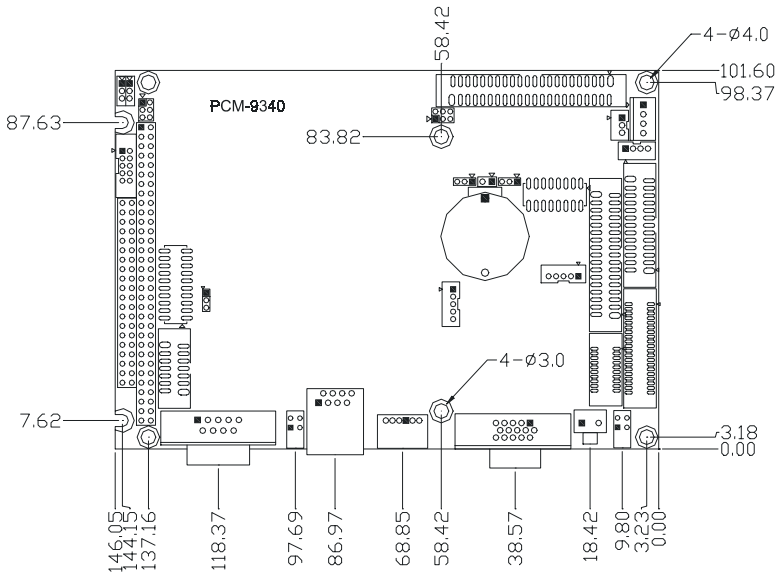

Figure E.1: Mechanical Drawing (component side)

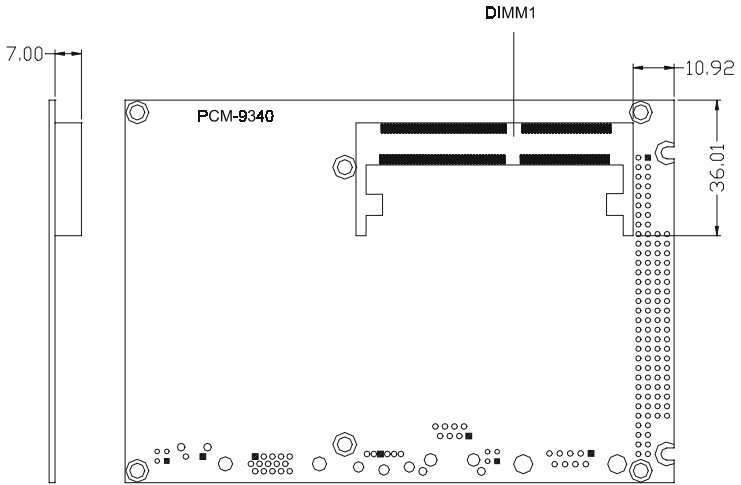

Figure E.2: PCM-9340 Mechanical Drawing (solder side)

