

PC/104 PCMCIA Module

PCM-3110

PCM-3111

PCM-3115B

PCM-3110B

PCM-3113

PCM-3114

Copyright Notice

This document is copyrighted, 1997. All rights are reserved. The original manufacturer reserves the right to make improvements to the products described in this manual at any time without notice.

No part of this manual may be reproduced, copied, translated or transmitted in any form or by any means without the prior written permission of the original manufacturer. Information provided in this manual is intended to be accurate and reliable. However, the original manufacturer assumes no responsibility for its use, nor for any infringements upon the rights of third parties which may result from its use.

Acknowledgments

Windows 3.1/95/NT, Flash File System (FFS) and MS-DOS are registered trademarks of Microsoft Corp.

True Flash File System (TFFS) is a registered trademark of M-Systems Flash Disk Pioneers

PC/AT is a registered trademark of IBM

CardWizard, CardSoft, CardWorks and SystemSoft are registered trademarks of SystemSoft Corporation

PCMCIA is a registered trademark of Personal Computer Memory Card Association

Pentium and Pentium Pro are registered trademarks of Intel Corporation

PC/104 and the PC/104 logo are trademarks of the PC/104 consortium

All other product names or trademarks are properties of their respective owners.

Packing list

Before you begin installing your module, make sure that the following materials have been shipped:

- 1 PC/104 PCMCIA module
- 1 user's manual (this document)
- 1 driver disk for Windows 3.1
- PC/104 module mounting supports

If any of these items are missing or damaged, contact your distributor or sales representative immediately.

Table of Contents

Preface

INTRODUCING PCMCIA CARDS

Introduction	i
What are PCMCIA Cards?	i
Type I Cards	ii
Type II Cards	ii
Type III Cards	ii
SRAM and Flash Memory Cards	ii
PCMCIA Memory Card Formatting Options	ii
Formatting SRAM Cards	iii
Formatting Flash Cards	iii
What is PC/104?	iv
Introduction	iv
Advantages of PC/104	iv

Chapter 1.

PRODUCT OVERVIEW

Introduction	1-1
Product Models	1-1
Common Specifications	1-2
Power consumption (typical)	1-2
Environmental specifications	1-2
Dimensions	1-2
System requirements	1-2
Addressing	1-2
PCM-3110	1-3
PCM-3110 Specifications	1-3
PCM-3111 (to be used with PCM-3110)	1-4
PCM-3111 Specifications	1-4
PCM-3115B	1-5
PCM-3115B Specifications	1-5
PCM-3110B	1-6
PCM-3110B Specifications	1-6
PCM-3113 (to be used with PCM-3110B)	1-7
PCM-3113 Specifications	1-7
PCM-3114 (to be used with PCM-3110B)	1-7
PCM-3114 Specifications	1-7
PC/104 PCMCIA Module Software	1-8

Chapter 2.

HARDWARE INSTALLATION

Introduction	2-1
System Requirements (All models)	2-1
Setting jumpers	2-2
PCM-3110 Hardware Installation	2-3
Package Contents Checklist	2-3
PCM-3110 Jumper Settings	2-4
Installation Procedure	2-5
PCM-3111 Hardware Installation	2-7
Package Contents Checklist	2-7
Installation Procedure	2-8
PCM-3115B Hardware Installation	2-9
Package Contents Checklist	2-9
PCM-3115B Jumper Settings	2-10
Installation Procedure	2-11
Socket Configuration on the PCM-3115B	2-11
PCM-3110B Hardware Installation	2-12
Package Contents Checklist	2-12
PCM-3110B Jumper Settings	2-13
Installation Procedure	2-14
PCM-3113 Hardware Installation	2-15
Package Contents Checklist	2-15
Installation Procedure	2-17
PCM-3114 Hardware Installation	2-19
Package Contents Checklist	2-19
Installation Procedure	2-20

Chapter 3.

SOFTWARE INSTALLATION

Introduction	3-1
Installing CardSoft 3.1 for DOS	3-2
SystemSoft CardSoft 3.1 & FFS Installation Guide	3-3
Installing CardWizard for Windows 3.1/3.11	3-5
System Requirements	3-5
CardWizard Installation	3-5
CONFIG.SYS Menu Partitions	3-6
Express Setup	3-6
Custom Installation	3-6
Typical System File Modifications	3-7
CONFIG.SYS	3-7
SYSTEM.INI	3-7
EMM386 Exclusions	3-8
Notes About Your CardWizard Software	3-8
Installing CardWorks for Windows 95	3-9
CardWorks Installation	3-9
Installing CardWizard-NT for Windows NT	3-10
How to Use CardWizard NT	3-10
Introduction	3-11

Chapter 4.

USING MEMORY CARDS

Introduction	4-1
Memory Card Drive Letter Assignments	4-1
Using SRAM Memory Cards	4-2
SRAM Card Beep Codes	4-3
Formatting SRAM Cards	4-3
Making SRAM Cards Bootable	4-3
Deleting Data on an SRAM Card	4-4
Using Flash Memory Cards	4-4
Flash Memory Card Beep Codes	4-5
Formatting Flash Memory Cards	4-5
Erasing Flash Memory Cards	4-6
Booting from Linear Flash Cards	4-7
Using M-Systems PCMCIA Flash Disk - TrueFFS	4-7
Installing M-Systems TrueFFS software	4-8
Formatting your Flash Card as a Bootable Flash Card	4-8

Chapter 5.

USING I/O CARDS

Introduction 5-1
I/O Card Beep Codes 5-2
PCMCIA I/O Card Types 5-2
 Modem and Fax/Modem Cards 5-2
 PCMCIA Network Cards 5-3
 PCMCIA LAN Card Software in General 5-5

Chapter 6.

USING ATA DISK DRIVE CARDS

Introduction 6-1
ATA Hard Disk Drive Beep Codes 6-1
ATA HDD Drive Letter Assignments (Non bootable) 6-2
Making ATA HDD/Flash Cards Bootable 6-4
 Bootable ATA Flash Card Letter Assignments 6-6

Appendix A

CardMaster-104 Pin Assignments

PC/104 Bus Connectors (PCM-3110, 3110B, 3111, 3115B) A-1
80-Pin Flat Cable (PCM-3110 and 3111) A-3
2 x 50-Pin Connectors (PCM-3110B, 3113 and PCM-3114) A-5
FDD Cable and FDD Power connector (PCM-3114) A-8
Floppy drive connector A-9
Power Connector A-9

Chapter 1.

PRODUCT OVERVIEW

Introduction

Until recently, the use of PCMCIA cards has been restricted to portable computers. Desktop systems rarely included a PCMCIA interface.

If you use a portable computer with a PCMCIA slot, any programs or data you have on PCMCIA memory cards have to be copied to diskette before being transferred to your desktop PC, which can be both time consuming and inconvenient. You may also be using a PCMCIA modem card, network card and/or ATA hard disk drive with your portable computer, none of which can be used on a standard desktop system, resulting in wasted resources and additional inconvenience.

The PC/104 PCMCIA Module series of products is designed to provide a PCMCIA card interface for desktop PCs in order to facilitate the transfer of data and sharing of devices between portable computers and desktop PCs. PC/104 PCMCIA Module complies fully with PCMCIA v.2.10 and JEIDA v.4.1. specifications, which define the industry standard for PCMCIA cards. By installing a PC/104 PCMCIA Module on your desktop system, you will be able to make full use of all data stored on PCMCIA memory cards and PCMCIA devices on both your portable and desktop systems.

Product Models

There are six models in the PC/104 PCMCIA Module series and this manual refers to all models. The hardware configuration of the models is different and separate instructions for hardware installation are given for each model. Note that the instructions on software installation and usage refer to all models. The key features of each model in the PC/104 PCMCIA Module series are described below.

Common Specifications

Power consumption (typical)

- Voltage: 5 V
- Operating voltage: 350 mA
- Flash voltage: 450 mA

Environmental specifications

- Operating temperature: 0° C to 70° C
- Storage temperature: -20° C to 85° C
- Relative humidity: £ 90%

Dimensions

- PC-104 controller card: 96 (L) x 90 (W) x 15 (H) mm
- Internal drive: standard 3.5" FDD form factor

System requirements

- PC/AT compatible computer with minimum 640 KB RAM
- MS-DOS 5.0 or newer
- Microsoft Windows 3.0 or newer

Addressing

I/O address:	3E0 - 3E1H
ROM address:	C8000 - CFFFF (32 KB)
	D8000 - DFFFF (32 KB)
	E0000 - E7FFF (32 KB)
	E8000 - EFFFF (32 KB)

Memory address: software adjustable, 16 KB mapping for each socket from D0000 - DFFFF

PCM-3110

The PCM-3110 model consists of a PC/104 (16-bit) interface module with one built-in PCMCIA card slot. The PC/104 interface module can be stacked with other PC/104 modules, mounted on a custom carrier board or stacked directly on a CPU card. The PCMCIA slot is built into the interface board. The PCM-3110 model is ideal for users who require a PCMCIA interface where easy accessibility to the PCMCIA drive is not required. The PCMCIA slot on the PCM-3110 provides full support for all Type I, Type II and Type III PCMCIA memory, I/O and ATA hard disk cards.

PCM-3110 Specifications

- Complies with PCMCIA v. 2.10 and JEIDA v.4.1
- Accepts Type I/II/III PCMCIA cards
- 16-bit data bus
- Supports secondary PCMCIA drive PCM-3111 (optional, see below)
- Programmable 8 KB SMD-type boot Flash BIOS
- Busy and battery status LED
- Single +5 V (@ 70 mA) power supply
- Supports reading/writing Flash cards using FTL and TFFS
- Supports bootable function from linear Flash, ATA hard disk and ATA Flash cards and SRAM cards

PCM-3111 (to be used with PCM-3110)

The PCM-3111 model consists of a PC/104 (16-bit) interface module with one built-in PCMCIA card slot. It can be stacked with the PCM-3110, with connections being maintained with the 104-pin bus connector. It can also be mounted on a custom carrier board to form a separate stand-alone unit. The PCMCIA slot is built into the interface card. The PCMCIA slot on the PCM-3111 provides full support for all Type I, Type II and Type III PCMCIA memory, I/O and ATA hard disk cards.

PCM-3111 Specifications

- Complies with PCMCIA v. 2.10 and JEIDA v.4.1
- Accepts Type I/II/III PCMCIA cards
- 16-bit data bus
- 80-pin mini connector connects to PCM-3110
- Single +5 V (@ 70 mA) power supply
- Supports all the functions of the PCM-3110

PCM-3115B

The PCM-3115B model consists of a PC/104 (16-bit) interface module with two built-in PCMCIA card slots. The PC/104 interface module can be stacked with other PC/104 modules, mounted on a custom carrier board or stacked directly on a CPU card. Two PCMCIA slots are built into the interface board. The PCM-3115B is ideal for users who require two PCMCIA interface slots where easy accessibility to the PCMCIA slots is not required. The PCMCIA slots on the PCM-3115B provides full support for all Type I, Type II and Type III PCMCIA memory, I/O and ATA hard disk cards.

PCM-3115B Specifications

- Complies with PCMCIA v. 2.10 and JEIDA v.4.1
- Accepts Type I/II/III PCMCIA cards
- 16-bit data bus
- Features two PCMCIA drives
- Programmable 32 KB SMD-type boot EEPROM BIOS
- Bootable from linear Flash card or ATA Flash, ATA HDD and SRAM cards
- Busy status LED
- Single +5 V (@ 70 mA) power supply

PCM-3110B

The PCM-3110B model consists of a PC/104 (16-bit) interface module with one built-in PCMCIA card slot. The PC/104 interface module can be stacked with other PC/104 modules, mounted on a custom carrier board or stacked directly on a CPU card. The PCMCIA slot is built into the interface board. The PCM-3110B also features two 50-pin connectors to interface with optional PCMCIA drives that fit in a 3.5" FDD bay (see PCM-3113 and PCM-3114 below). The PCM-3110B model is ideal for users who require both an inaccessible PCMCIA drive and an interface with a second PCMCIA drive that is mounted in a computer's FDD bay. The PCMCIA slot on the PCM-3110B provides full support for all Type I, Type II and Type III PCMCIA memory, I/O and ATA hard disk cards.

PCM-3110B Specifications

- Complies with PCMCIA v. 2.10 and JEIDA v.4.1
- Accepts Type I/II/III PCMCIA cards
- 16-bit data bus
- Supports secondary PCMCIA drives PCM-3113 and PCM-3114 through two 50-pin connectors (optional, see below)
- Programmable 32 KB SMD-type boot Flash BIOS
- Busy status LED
- Single +5 V (@ 70 mA) power supply
- Supports reading/writing Flash cards using FTL and TFFS
- Supports bootable function from linear Flash, ATA hard disk drive, ATA Flash cards and SRAM cards

PCM-3113 (to be used with PCM-3110B)

The PCM-3113 is a PCMCIA reader/writer that fits in a 3.5" FDD bay and can be connected to the PCM-3110B with a 2 x 50-pin flat cable. It gives you a second PCMCIA slot with the convenience of mounting it on the front of your case for easy accessibility. All Type I SRAM and Flash memory cards, Type II I/O device cards and Type III ATA hard disk drive cards can be used in both slots.

PCM-3113 Specifications

- Same functions as PCM-3110B
- Fits in a 3.5" FDD bay in your computer case

PCM-3114 (to be used with PCM-3110B)

The PCM-3114 is a combination PCMCIA reader/writer and a 1.44 MB floppy disk drive that fits in your computer's 3.5" FDD bay. It connects with the PCM-3110B with a 2 x 50-pin flat cable. The PCM-3114 is ideal for users that require both a PCMCIA and 3.5" FDD interface to be mounted within their computer's 3.5" FDD bay.

PCM-3114 Specifications

- Complies with PCMCIA v. 2.10 and JEIDA v.4.1
- Accepts Type I/II/III PCMCIA cards
- Provides one 1.44 FDD drive and one PCMCIA slot within a housing that mounts in your computer's 3.5" FDD bay
- Supports SRAM, Flash, ATA Flash, ATA HDD and I/O cards
- Supports reading/writing Flash cards using FTL and TFFS

PC/104 PCMCIA Module Software

All of the above models are bundled with your choice of one of the following PCMCIA software packages from SystemSoft Corporation:

- **Cardsoft 3.1** for DOS 5.0 or higher
- **CardWizard** for Windows 3.1 or higher (default)
- **CardWorks** for Windows 95
- **CardWizard-NT** for Windows NT

Additional software is available for purchase separately.

SystemSoft **Cardsoft/CardWizard/CardWorks** software includes all the necessary drivers and utilities to enable you to take full advantage of the capabilities offered by all types of PCMCIA cards. The software comes with its own install program which automatically configures your computer to support all functions.

Chapter 2.

HARDWARE INSTALLATION

Introduction

As we have mentioned, there are six models in the PC/104 PCMCIA Module series: PCM-3110, PCM-3111, PCM-3115B, PCM-3110B, PCM-3113 and PCM-3114. The components and hardware installation procedures are different for all the models, and separate instructions are provided in this chapter.

Please check to see which model you have purchased before reading these instructions. Read only the instructions referring to the model you have purchased and ignore the other instructions.

System Requirements (All models)

Please note that all models in the PC/104 PCMCIA Module series require a system conforming to the following specifications:

- IBM PC/AT, including all 80286, 80386, 80486, Pentium and Pentium Pro processor-based computers
- Hard disk drive
- MS-DOS 5.0 or above, Windows 3.1, Windows 95 or Windows NT
- One PC/104 connector
- One empty 3.5" floppy disk drive bay (PCM-3113 and PCM-3114 only)

Setting jumpers

The PCM-3110, PCM-3115B and PCM-3110B requires you to set jumpers in order to configure the module for your specific application. A jumper consists of two metal pins and a small metal clip (often protected by a plastic cover) that slides over the pins to connect them, thus completing an electric circuit. Closing a jumper means connecting the pins with the metal pin, while opening the jumper requires you to remove the pin.

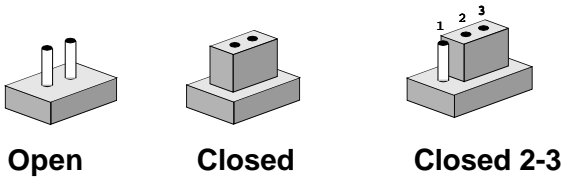

The jumper settings are represented in this manual with the following diagrams:



A pair of nonmagnetic, needle-nosed pliers may be helpful when working with jumpers. In order to prevent an unused jumper from getting lost, you may leave it inserted on a single jumper pin.

PCM-3110 Hardware Installation

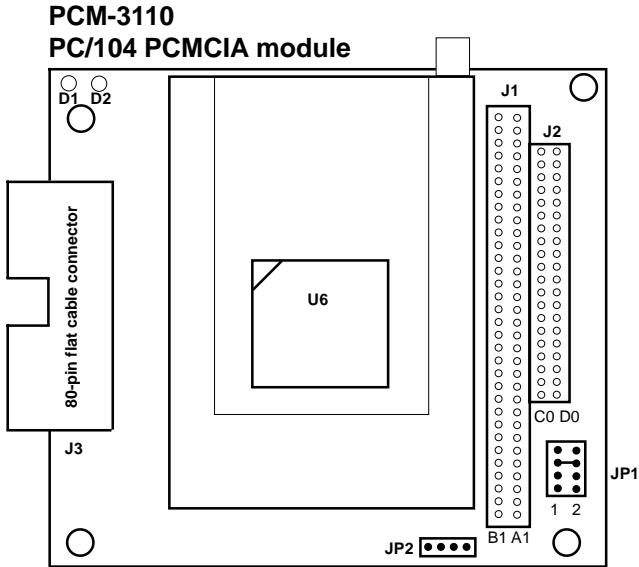

D1 LED: Battery LED (Yellow)

D2 LED: Busy LED (Red)

I/O Address: 3E0h/3E1h

IRQ: Interrupt steering for the card status change interrupt

JP2: External power connector

Package Contents Checklist

When you open your PCM-3110 for the first time, first check that all the following items are present:

- One PCM-3110 PCMCIA module
- Your choice of one of the following PCMCIA software packages from SystemSoft Corporation: Cardsoft 3.1 for DOS 5.0 or higher, CardWizard for Windows 3.1 or higher, CardWorks for Windows 95, Cardwizard-NT for Windows NT. Additional software is available for purchase separately.
- Spacer and screw
- This user's manual.

If any of the above items is missing or appears to be damaged in any way, please consult with the dealer from whom you purchased your unit immediately.

PCM-3110 Jumper Settings

The PCM-3110 includes one jumper JP1 that must be set before installation. These jumpers control the BIOS address:

Read from Boot ROM*

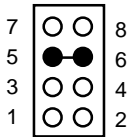

JP1

Write to Boot ROM

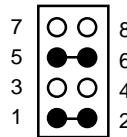

JP1

The settings for JP1 are as follows:

- Close pins 1-2: Write data to Flash ROM (28C64)
- Close pins 3-4: Set BIOS address CA000 - CB000 (8KB)
- *Close pins 5-6: Set BIOS address CC000 - CD000 (8KB)
- Close pins 7-8: Set BIOS address CE000 - CF000 (8KB)
- Close pins 5-6/7-8: Disable Boot ROM function

Note: * denotes default setting (shown above, at left)

Installation Procedure

To install the PCM-3110 in your system, follow the instructions below.

1. Turn off the power to your PC and all peripherals connected to your system.
2. Open your system case. This procedure will vary according to the particular system you own and you should consult with the relevant user's manual for details.
3. Set the jumpers as shown previously.
4. Mount the PCM-3110 in your system as required. You may stack the PCM-3110 on another PC/104 module using the supports, plug the PCM-3110 into a custom carrier board, or else mount it directly on a CPU card with PC/104 connector. The two PC/104 connectors (i.e. the 64-pin J1 and the 40-pin J2) on the bottom of the board fit into the sockets on the device on which you are mounting
5. Your PCM-3110 is now installed. Proceed with the software installation.
6. If you have purchased the PCM-3111 secondary PCMCIA drive, proceed with the instructions in the following section.
7. Close your system case.

Your PCM-3110 is now installed in your system and you should proceed with your software installation.

PCM-3111
PC/104 PCMCIA module

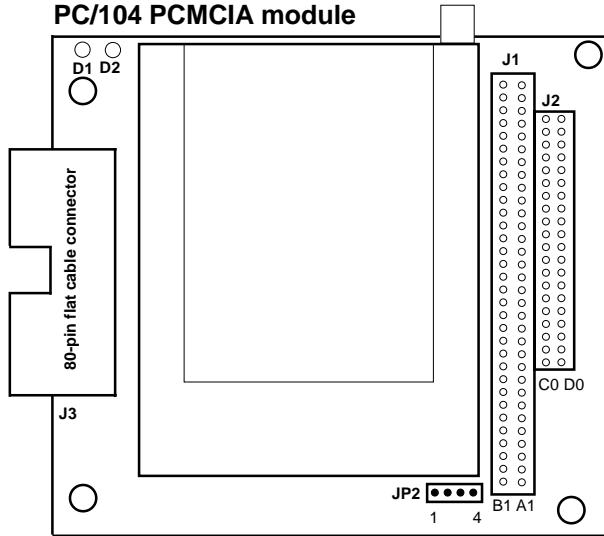

PCM-3110
PC/104 PCMCIA module

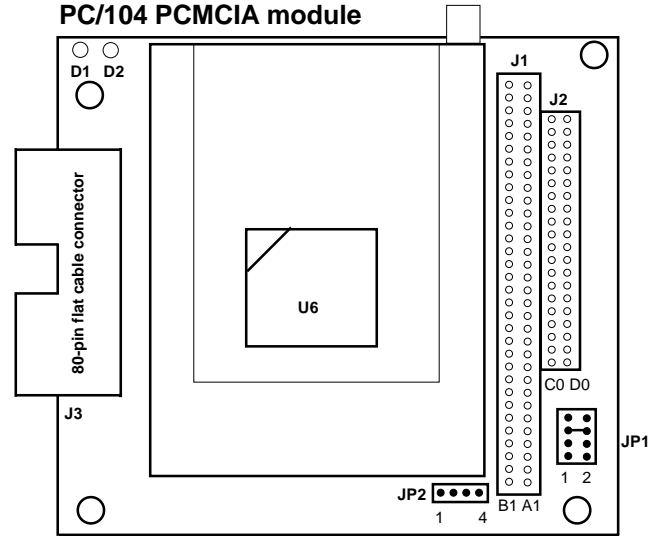

Connect connectors J3 with 80-pin flat cable (align red line with pin 1)

D1 LED: Battery LED (Yellow)

D2 LED: Busy LED (Red)

I/O Address: 3E0h/3E1h

IRQ: Interrupt steering for the card status change interrupt

PCM-3111 Hardware Installation

Package Contents Checklist

When you open your PCM-3111 for the first time, first check that all the following items are present:

- One PCM-3111 PCMCIA module
- Your choice of one of the following PCMCIA software packages from SystemSoft Corporation: Cardsoft 3.1 for DOS 5.0 or higher, CardWizard for Windows 3.1 or higher, CardWorks for Windows 95, Cardwizard-NT for Windows NT. Additional software is available for purchase separately.
- 80-pin flat cable
- Spacer and screw
- This user's manual.

If any of the above items is missing or appears to be damaged in any way, please consult with the dealer from whom you purchased your unit immediately.

The PCM-3111 does not have any jumpers to set.

Installation Procedure

To install the PCM-3111 in your system, follow the instructions below.

1. Turn off the power to your PC and all peripherals connected to your system.
2. Open your system case. This procedure will vary according to the particular system you own and you should consult with the relevant user's manual for details.
3. Install your PCM-3110 according to the directions in the previous section.
4. Mount the PCM-3111 in your system as required. The PCM-3111 cannot be used by itself; it must be used in conjunction with PCM-3110. You may stack the PCM-3111 on another PC/104 module (such as your PCM-3110) using the supports, plug the PCM-3111 into a custom carrier board, or else mount it directly on a PC/104 CPU card. The two PC/104 connectors (i.e. the 64-pin J1 and the 40-pin J2) on the bottom of the board fit into the sockets on the device on which you are mounting
5. Connect an 80-pin flat cable between connectors J3 on your PCM-3110 and PCM-3111. Make sure that pin 1 of PCM-3110 is connected to pin 1 of PCM-3111.
6. Your PCM-3111 is now installed. Proceed with the software installation.
7. Close your system case.

Your PCM-3111 is now installed in your system and you should proceed with your software installation.

PCM-3115B Hardware Installation

PCM-3115B 2-slot PC/104 PCMCIA module

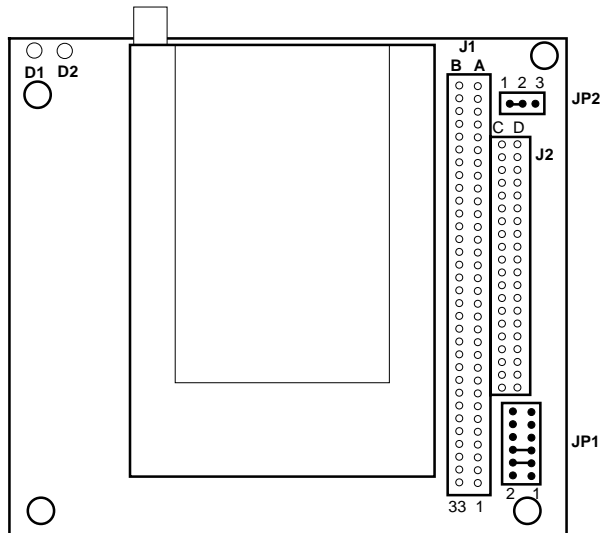

D1 LED: Busy LED (Red)

D2 LED: Busy LED (Red)

I/O Address: 3E0h/3E1h

IRQ: Interrupt steering for the card status change interrupt

Package Contents Checklist

When you open your PCM-3115B for the first time, first check that all the following items are present:

- One PCM-3115B, 2-slot PCMCIA module
- Your choice of one of the following PCMCIA software packages from SystemSoft Corporation: Cardsoft 3.1 for DOS 5.0 or higher, CardWizard for Windows 3.1 or higher, CardWorks for Windows 95, Cardwizard-NT for Windows NT. Additional software is available for purchase separately.
- Spacer and screw
- This user's manual.

If any of the above items is missing or appears to be damaged in any way, please consult with the dealer from whom you purchased your unit immediately.

PCM-3115B Jumper Settings

The PCM-3115B includes two jumpers, JP1 and JP2, that must be set before installation. These jumpers control the BIOS address (Boot ROM function):

Read from Boot ROM*

Write Data to Boot ROM

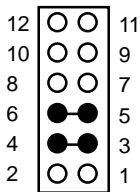

JP1

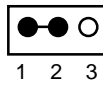

JP2

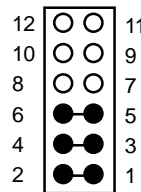

JP1

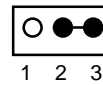

JP2

JP2 controls the ability to write data to the Boot ROM. Closing pins 2-3 enables writing. Using the Boot ROM requires pins 1-2 to be closed.

The settings for JP1 are as follows. To enable the Boot ROM function pins 3-4 must be closed:

Close pins 1-2

*Close pins 3-4

*Close pins 5-6:

Close pins 7-8:

Close pins 9-10:

Close pins 11-12:

Load data to Flash ROM (28F1000)

Enable Boot ROM*

Set BIOS address C8000-CFFF(32KB)

Set BIOS address D8000-DFFF(32KB)

Set BIOS address E0000-E7FFF(32KB)

Set BIOS address E8000-EFFFF(32KB)

Note: * denotes default setting (shown above at left)

Installation Procedure

To install the PCM-3115B in your system follow the instructions below.

1. Turn off the power to your PC and all peripherals connected to your system.
2. Open your system case. This procedure will vary according to the particular system you own and you should consult with the relevant user's manual for details.
3. Set the jumpers as shown previously.
4. Mount the PCM-3115B in your system as required. You may stack the PCM-3115B on another PC/104 module using the supports, plug the PCM-3115B into a custom carrier board, or else mount it directly on a PC/104 CPU card. The two PC/104 connectors (i.e. the 64-pin J1 and the 40-pin J2) on the bottom of the board fit into the sockets on the device on which you are mounting.
5. Your PCM-3115B is now installed. Proceed with the software installation.
6. Close your system case.

Your PCM-3115B is now installed in your system and you should proceed with your software installation.

Socket Configuration on the PCM-3115B

It is important to note that with two PCMCIA sockets, one is always Socket 1 and Socket 2. The socket configuration for the PCM-3115B is as follows:

Lower socket= Socket 1
Upper socket = Socket 2

PCM-3110B Hardware Installation

Package Contents Checklist

When you open your PCM-3110B for the first time, first check that all the following items are present:

- One PCM-3110B PCMCIA module
- Your choice of one of the following PCMCIA software packages from SystemSoft Corporation: Cardsoft 3.1 for DOS 5.0 or higher, CardWizard for Windows 3.1 or higher, CardWorks for Windows 95, Cardwizard-NT for Windows NT. Additional software is available for purchase separately.
- Spacer and screw
- This user's manual.

If any of the above items is missing or appears to be damaged in any way, please consult with the dealer from whom you purchased your unit immediately.

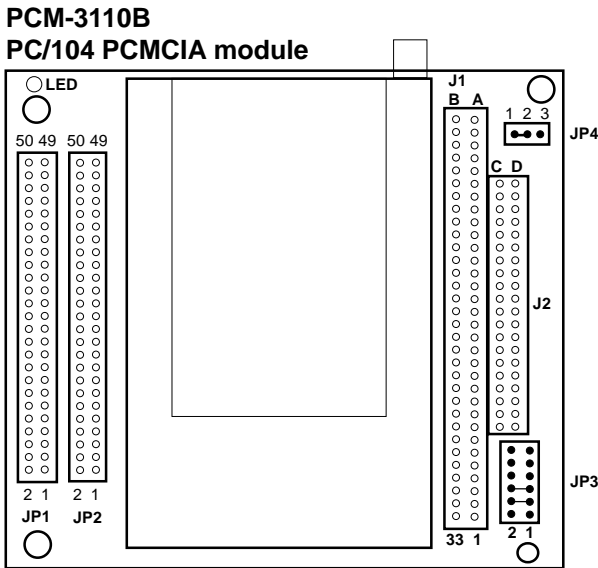

I/O Address: 3E0h/3E1h
IRQ: Interrupt steering for the card status change interrupt
LED: Busy LED (Red)

PCM-3110B Jumper Settings

The PCM-3110B includes two jumpers JP3 and JP4 that must be set before installation. These jumpers control the BIOS address:

Read from Boot ROM*

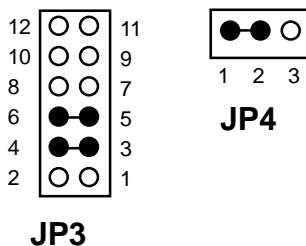

Write to Boot ROM

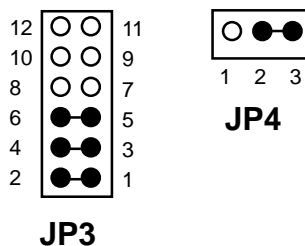

JP4 controls the ability to write data to the Boot ROM. Closing pins 2-3 enables writing. Using the Boot ROM requires pins 1-2 to be closed.

To enable the Boot ROM function, pins 3-4 must be closed. The settings for JP3 are as follows:

Close pins 1-2	Load data to Flash ROM (28F1000)
*Close pins 3-4	Enable Boot ROM
*Close pins 5-6	Set BIOS address C8000-CFFFF (32KB)
Close pins 7-8:	Set BIOS address D8000-DFFFF (32KB)
Close pins 9-10:	Set BIOS address E0000-E7FFF (32KB)
Close pins 11-12:	Set BIOS address E8000-EFFFF (32KB)

Note: * denotes default setting (shown above at left)

Installation Procedure

To install the PCM-3110B in your system follow the instructions below.

1. Turn off the power to your PC and all peripherals connected to your system.
2. Open your system case. This procedure will vary according to the particular system you own and you should consult with the relevant user's manual for details.
3. Set the jumpers as shown previously.
4. Mount the PCM-3110B in your system as required. You may stack the PCM-3110B on another PC/104 module using the supports, plug the PCM-3110B into a custom carrier board, or else mount it directly on a PC/104 CPU card. The two PC/104 connectors (i.e. the 64-pin J1 and the 40-pin J2) on the bottom of the board fit into the sockets on the device on which you are mounting
5. Your PCM-3110B is now installed. Proceed with the software installation.
6. If you have purchased the PCM-3113 secondary PCMCIA drive or the PCM-3114 dual 3.5" FDD/PCMCIA drive, proceed with the instructions in the following section.
7. Close your system case.

Your PCM-3110B is now installed in your system and you should proceed with your software installation.

PCM-3113 Hardware Installation

Package Contents Checklist

When you open your PCM-3113 for the first time, first check that all the following items are present:

- One PCM-3113 PCMCIA module
- 2 x 50-pin flat cable
- Mounting screws
- This user's manual.

If any of the above items is missing or appears to be damaged in any way, please consult with the dealer from whom you purchased your unit immediately.

There are no jumpers to set on the PCM-3113.

PCM-3113
PCMCIA drive with 3.5" FDD form factor

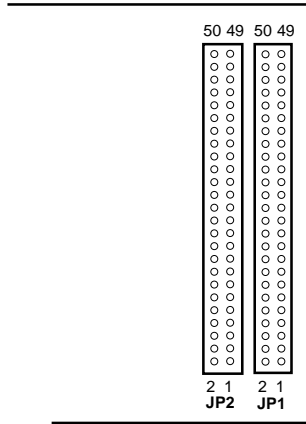

PCM-3110B
PC/104 PCMCIA module

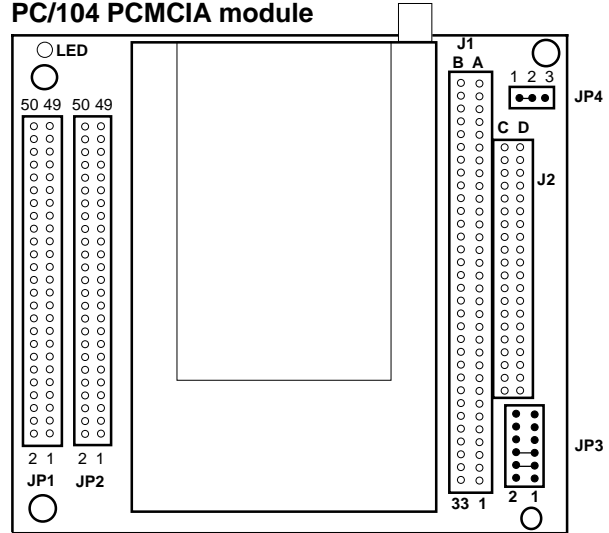

Connect with 2 x 50-pin flat cable (align red line with pin 1)

I/O Address: 3E0h/3E1h

IRQ: Interrupt steering for the card status change interrupt

PCM-3113

PCM-3110B

D1 LED: Power LED (Green)

LED: Busy LED (Red)

D2 LED: Battery LED (Yellow)

D3 LED: Busy LED (Red) {Not shown}

Installation Procedure

To install the PCM-3113 in your system follow the instructions below.

1. Turn off the power to your PC and all peripherals connected to your system.
2. Open your system case. This procedure will vary according to the particular system you own and you should consult with the relevant user's manual for details.
3. Install the PCM-3110B according to the previous instructions.
4. Mount the PCM-3113 in a free 3.5" FDD bay, normally found on the front of your computer.
5. Connect a 2 x 50-pin flat cable between connectors JP1 and JP2 on your PCM-3110B and PCM-3113. Make sure that pin 1 of PCM-3110B is connected to pin 1 of PCM-3113. Align the red line on the flat cable with pin 1.
6. Close your system case.

Your PCM-3113 is now installed in your system.

PCM-3114
Dual FDD/PCMCIA combination drive

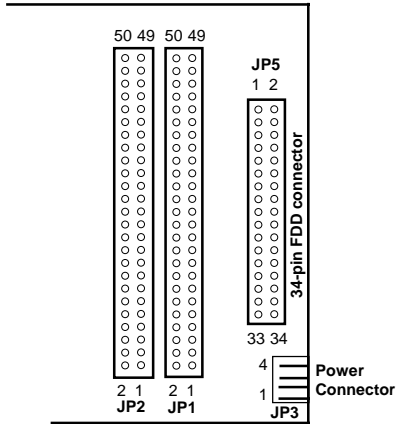

PCM-3110B
PC/104 PCMCIA module

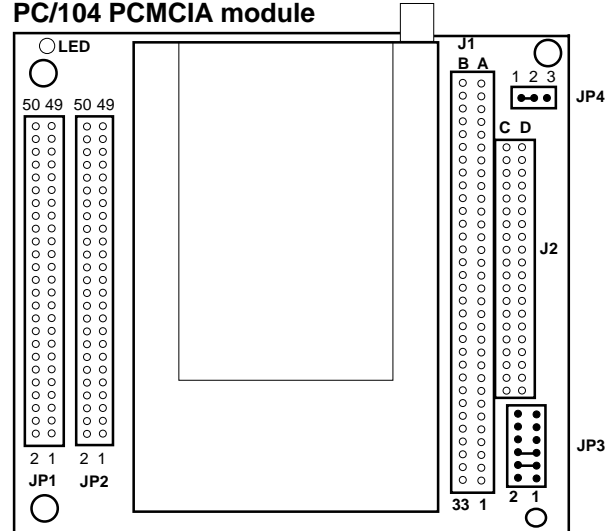

Connect with 2 x 50-pin flat cable (align red line with pin 1)

I/O Address: 3E0h/3E1h

IRQ: Interrupt steering for the card status change interrupt

PCM-3114

PCM-3110B

LED: Busy LED (Red)

LED: Busy LED (Red)

PCM-3114 Hardware Installation

Package Contents Checklist

When you open your PCM-3114 for the first time, first check that all the following items are present:

- One PCM-3114 combination PCMCIA module and 3.5" FDD drive
- 2 x 50-pin flat cable
- Mounting screws
- This user's manual.

If any of the above items is missing or appears to be damaged in any way, please consult with the dealer from whom you purchased your unit immediately.

There are no jumpers to set on the PCM-3114

Installation Procedure

To install the PCM-3114 in your system follow the instructions below.

1. Turn off the power to your PC and all peripherals connected to your system.
2. Open your system case. This procedure will vary according to the particular system you own and you should consult with the relevant user's manual for details.
3. Install the PCM-3110B according to the previous instructions.
4. Mount the PCM-3114 in a free 3.5" FDD bay, normally found on the front of your computer.
5. Connect a 2 x 50-pin flat cable between connectors JP1 and JP2 on your PCM-3110B and PCM-3114. Make sure that pin 1 of PCM-3110B is connected to pin 1 of PCM-3114. Align the red line on the flat cable with pin 1.
6. Connect a 34-pin FDD cable between connector JP5 on your PCM-3114 and the FDD controller on your system's main board. Consult your main board's user's manual for the location of the FDD connector.
7. Connect a 4-pin mini power cable to the power connector on the PCM-3114. This supplies power to the 3.5" FDD drive.
6. Close your system case.

Your PCM-3114 is now installed in your system and you should proceed with your software installation.

Chapter 3.

SOFTWARE INSTALLATION

Introduction

Your PC/104 PCMCIA Module is supplied with your choice of one of the following bundled software packages from SystemSoft Corporation:

- Cardsoft 3.1 for DOS 5.0 or higher
- CardWizard for Windows 3.1 or higher & FTL
- CardWorks for Windows 95 or higher
- CardWizard-NT for Windows NT

Additional software is available for purchase separately.

Note

This chapter is intended to be a “Quick Start” guide to installing SystemSoft PCMCIA card software. All of the bundled programs provides extensive documentation, and we recommend that you consult the on-line documentation and README files for detailed information about using the Cardsoft/CardWizard/CardWorks software.

Before you can use any PCMCIA card with your PC/104 PCMCIA Module unit, you must install the software provided. All PCMCIA cards require certain device drivers to be installed before you can use them and you should not attempt to use any type of PCMCIA card before the software has been correctly installed.

Because the original PC configuration did not include support for PCMCIA devices, your system will not be able to recognize such devices before the software has been installed. The SystemSoft **Cardsoft/CardWizard/CardWorks** PCMCIA software provides all the drivers necessary to allow you to use SRAM and Flash memory cards and Type II and Type III I/O devices including modems, fax/modems, LAN cards and ATA hard disk drives.

The software includes automatic installation programs which will make the necessary modifications to your CONFIG.SYS file to allow you to access your PCMCIA card slots. Please follow the instructions in this chapter carefully in order to ensure that the software is correctly installed.

Installing CardSoft 3.1 for DOS

Installing the **CardSoft 3.1** for DOS on your hard disk drive is a simple procedure thanks to the automatic installation program provided with CardSoft. To install the **CardSoft 3.1** PCMCIA drivers proceed as follows:

1. Insert the 3.5" **CardSoft** software diskette into the A: floppy disk drive.
2. Make the A: drive the current drive by typing A: at the DOS prompt.
3. At the DOS prompt, type:

```
A>INSTALL
```

The installation program will start and guide you through the installation procedure. The installation program will ask you information regarding your system.

Note that **CardSoft** must always be copied to the C: hard disk drive and you may not specify a different drive.

The automatic installation program will copy the **CardSoft** PCMCIA driver files to the C: hard disk drive and amend the CONFIG.SYS file to ensure the PCMCIA drivers are loaded at boot up.

That is all you have to do to install the PC/104 PCMCIA Module software, but before proceeding please read the next section on the CONFIG.SYS file to ensure that your CONFIG.SYS is correctly configured to enable the PC/104 PCMCIA Module drivers to be loaded.

SystemSoft CardSoft 3.1 & FFS Installation Guide

1. Install all cables to your PC/104 PCMCIA Module
2. Insert **CardSoft 3.1** and **FFS** diskette into your floppy disk drive.
Type install
3. Insure that your config.sys file appears as follows:

```
DEVICE = C:\DOS\SETVER.EXE           (TYPE BY YOURSELF)
DEVICE = C:\DOS\HIMEM.SYS           (TYPE BY YOURSELF)
DOS = HIGH, UMB                      (TYPE BY YOURSELF)
DEVICE = C:\CARDSOFT\SSVADEM.EXE
DEVICE = C:\CARDSOFT\CS.EXE
DEVICE = C:\CARDSOFT\CSALLOC.EXE
DEVICE = C:\CARDSOFT\ATADRV.EXE
DEVICE = C:\CARDSOFT\MTAA.EXE
DEVICE = C:\CARDSOFT\MTAB.EXE
DEVICE = C:\CARDSOFT\MTI1.EXE
DEVICE = C:\CARDSOFT\MTI2P.EXE
DEVICE = C:\CARDSOFT\MTSRAM.EXE
DEVICE = C:\CARDSOFT\MTDDR.V.EXE
DEVICE = C:\CARDSOFT\SSMFLSH.SYS
DEVICE = C:\CARDSOFT\CARDID.EXE
```

Note

Install original DOS software to insure proper operation

4. Note the following details regarding memory card installation (where IDE HDD = C):
 - a. SRAM cards are bootable, readable and writeable. Drive letter assignments are first slot F and second slot G
 - b. Flash cards are readable, writeable but not bootable. Drive letter assignments are first slot F, second slot G. Format your Flash card before initial reading/writing by executing MCFORMAT.EXE.
 - c. ATA HDD/ATA Flash cards are bootable, readable and writeable. Drive letter assignments are first slot D, second slot E.

- d. When you use a PCMCIA drive with Boot ROM V. 2.0x with ATA HDD or ATA Flash cards, boot the system from drive C if the capacity of the card is greater than 15 MB. Boot from drive A if the the size of the PCMCIA card is less than 15 MB.
- e. If the address of any PCMCIA I/O card (fax/modem, network card) conflicts with the port address of any other cards, execute CONFIG.EXE under c:\cardsoft to correct the situation.

Installing CardWizard for Windows 3.1/3.11

CardWizard is a utility that assists with PCMCIA configuration and automatically diagnoses and resolves the most common PCMCIA and system problems.

System Requirements

The following items are the minimum requirements for **CardWizard**:

- Windows 3.1/3.11
- DOS 5.0 or later
- 1 or more PCMCIA slots
- 32 KB of DOS memory
- 4 MB RAM
- 4 MB of hard drive storage space

Note

Before installing the CardWizard software, remove any PCMCIA cards that may be in the slots of your PC/104 PCMCIA Module.

CardWizard Installation

The **CardWizard** installation must be done within Windows. **CardWizard** installs all DOS and Windows PCMCIA support in addition to the Windows **CardWizard** interface.

Insert the installation disk into the proper disk drive. For example, if drive A: is to be used:

From the Windows Program Manager:

1. choose Run from the file menu.
2. type: A:\SETUP

From the Windows File Manager:

1. choose Run from the File menu.
2. type: A:\SETUP

or select the A: drive then double click on SETUP.EXE file.

CONFIG.SYS Menu Partitions

If you wish to customize the handling of the CONFIG.SYS partitions, it is recommended that you choose Custom Installation. Choosing Custom will allow you greater flexibility in how you setup your CONFIG.SYS file. The Express Installation path will follow a pre-defined path as described in the next paragraph.

Express Setup

The Setup Utility will create a new menu item and menu section in the CONFIG.SYS file. Upon rebooting, you will be presented with a new option called "SystemSoft CardWizard." In the case that you are upgrading from a previous version of SystemSoft's PCMCIA software, the older software will be replaced with the newer **CardWizard** version and no new menu item will be created. The Setup Utility will de-install any other vendor's software it encounters.

Custom Installation

On a Custom Installation, the Setup Utility will present you with a screen that displays all of the different menus found in the CONFIG.SYS file. By clicking on the "Setup" button, you can inform the Setup Utility as to which menu sections you wish to install the drivers. Also, you can specify which cards you prefer to support in each menu.

Typical System File Modifications

Typical system file modifications are shown below:

CONFIG.SYS

```
DEVICEHIGH=C:\WINDOWS\EMM386.EXE NOEMS
X=D000-D7FF
DEVICEHIGH=C:\CARDWIZ\SSVADEM.EXE /SKT:2
DEVICEHIGH=C:\CARDWIZ\CS.EXE /POLL:1
DEVICE=C:\CARDWIZ\CSALLOC.EXE
DEVICEHIGH=C:\CARDWIZ\ATADRV.EXE /S:2
DEVICEHIGH=C:\CARDWIZ\MTI1.EXE
DEVICEHIGH=C:\CARDWIZ\MTI2P.EXE
DEVICEHIGH=C:\CARDWIZ\MTAA.EXE
DEVICEHIGH=C:\CARDWIZ\MTAB.EXE
DEVICEHIGH=C:\CARDWIZ\MTATM.EXE
DEVICEHIGH=C:\CARDWIZ\MTHB2.EXE
DEVICEHIGH=C:\CARDWIZ\MTDDRV.EXE
DEVICEHIGH=C:\CARDWIZ\MTSRAM.EXE
DEVICEHIGH=C:\CARDWIZ\FTL.EXE
DEVICEHIGH=C:\CARDWIZ\CARDID.EXE
```

SYSTEM.INI

[386Enh] {This is the only section changed}

```
EMMEXCLUDE=D000-D7FF
DEVICE=*VCD {This line is remarked, or
commented, out}
DEVICE=C:\CARDWIZ\PCCARD.386
DEVICE=C:\CARDWIZ\SSVRDD.386
DEVICE=C:\CARDWIZ\SSVCD311.386 (Windows
for Workgroups)
```

EMM386 Exclusions

The **CardWizard** Setup Utility looks for EMM386.EXE in the CONFIG.SYS file. If this driver is not in CONFIG.SYS, then the “EmmExclude=D000-D7FF” parameter is added in SYSTEM.INI to ensure that there are 32 KB of memory which can be used by CardWizard.

If EMM386 is installed in CONFIG.SYS, then the Setup Utility will check its memory exclusion range. If less than 32 KB are excluded, then the installation program will expand the exclusion range to 32 KB.

Notes About Your CardWizard Software

This version currently handles one Memory Manager (EMM386.EXE). It does not correct for memory conflicts that result from the presence of QEMM, 386MAX, or other memory managers.

CardWizard cannot correct problems for cards that require proprietary card services clients. It can, however, report any resource conflicts if the driver is installed properly. For example, if you have a PC card which has more than one function (i.e. Ethernet and Modem), you will need to load the additional driver which is provided with the card on top of the **CardWizard** software.

When running the **CardWizard** application in the minimized view format, there are two ways to maximize the window; you can double click on the icon with the mouse button; or you can use the <Alt>-<Space> key sequence. The icon will not maximize by using the <Enter> key.

Installing CardWorks for Windows 95

CardWorks is a Windows 95 software suite that includes SystemSoft's industry leading **CardSoft** & **CardWizard** PCMCIA card software to enhance the functionality of PCMCIA card technology in Windows 95. **CardWorks** is intended to make PCMCIA card use simple and straightforward, while affording the greatest compatibility in the computer industry.

CardWorks Installation

1. Turn on your computer and start Windows 95.
2. Insert the 3.5" **CardWorks** software diskette into the A: floppy disk drive.
3. Choose Start from the Windows 95 taskbar, and then choose Run.
4. Type a:setup and click OK

The InstallShield Wizard starts and guides you through the installation process.

Note

Windows 95 can support PCMCIA ATA HDD, ATA Flash and I/O cards. Windows 95 includes drivers for these devices. You must install CardWorks if you want to use SRAM or Flash cards.

Installing CardWizard-NT for Windows NT

This release of **CardWizard-NT** for Windows NT requires “Windows NT version 4.0 Golden” or a later release of Window NT version 4.0. You **MUST** have administrator privileges in order to install **CardWizard-NT** for Windows NT. From the Start Menu, the Explorer, or from a DOS prompt, run Setup.exe.

You will be presented with a list box of socket services to choose from. Select the Socket Services that is appropriate for your controller. Make sure that all other Socket Services are de-selected. For Intel 365 (and compatible) controllers, select the “SSIntel” option.

Note: The contents of the installation diskette can be copied to a directory on your hard disk, and setup can be run from this directory. We suggest if you do this that you create a new (empty) directory for this purpose. For example:

```
mkdir \WizInstall  
  
cd \WizInstall  
  
copy a:*. * .  
  
setup [optional step]
```

Setup can also be run from a network drive.

How to Use CardWizard-NT

CardWizard-NT is SystemSoft’s PC card support application to increase ease of use and provide seamless integration for users to configure PC cards.

Introduction

SystemSoft's **CardWizard-NT** is a Microsoft Windows NT application that creates a new standard for improving PC card ease of use. **CardWizard-NT** allows you to view PC card slots, trouble-shoot card configuration problems, resolve resource conflicts, receive notification of card activity and launch PC applications upon card insertion.

CardWizard-NT features an expert system that addresses advanced configuration issues. The expert system assumes the role of a computer-based technical support advisor. It will guide you through dialog boxes to diagnose and resolve many common PC compatibility problems.

CardWizard-NT for Windows NT supports hot-swapping of ATA PC cards and fax/modem cards. It also supports hot insertion (but not removal) of network PC cards. **CardWizard-NT** for Windows NT also currently supports boot timer insertion of SCSI PC cards. Boot time insertion requires that you shut down your system, insert the PC card, then reboot your system.

CardWizard-NT for Windows NT also works with the PowerProfiler Power Management system.

Chapter 4.

USING MEMORY CARDS

Introduction

PC/104 PCMCIA Module supports the use of the two main kinds of memory cards - SRAM cards and Flash memory cards. Though both these types of cards have the same function, i.e. to store data, the way in which they are formatted and used to store data is different. In this chapter we detail how to prepare SRAM and Flash memory cards to store data, and the relative merits of these two types of memory card.

Memory Card Drive Letter Assignments

Before you go on to learn how to use memory cards with PC/104 PCMCIA Module, it is important to understand how the drive letters are assigned to the PCMCIA slots. In particular you should note that the drive letter of the PCMCIA slot varies depending on whether the device inserted is a memory card or an ATA hard disk drive. This is different from a hard disk drive which is always fixed as C: or D:, etc.

After you have installed PC/104 PCMCIA Module in your system, when using memory cards the drive letter of the first PCMCIA socket (the PCM-3110, PCM-3111 and PCM-3110B models have only one socket) will become the drive after the last hard disk drive. For example, if you have one C: hard disk drive with one partition, then the 1st PCMCIA socket becomes the D: drive and the second (if present) is the E: drive. If you have two hard disk drives with two partitions each, i.e. C:, D:, E: and F:, then the first PCMCIA socket becomes the G: drive and the second the H: drive.

The memory card assignments when you install PC/104 PCMCIA Module devices is summarized as follows:

Single PCM-3110: Assigned as socket 1

PCM-3110 and PCM-3111: PCM-3110 is socket 1 and PCM-3111 is socket 2

PCM-3115B: Bottom socket is socket 1, top socket is socket 2

Single PCM-3110B: PCM-3110B is socket 1

PCM-3110B and PCM-3113: PCM-3110B is socket 1 and PCM-3113 is socket 2

PCM-3110B and PCM-3114: PCM-3110B is socket 1 and PCM-3114 is socket 2

Refer to the SystemSoft 3.1 & FFS Installation Guide on page 3-3 for detailed information about PCMCIA drive letter assignments.

Using SRAM Memory Cards

SRAM cards are the simplest PCMCIA medium for data storage, functioning in much the same way as floppy diskettes. They are easy to format and data can be written to and erased from the card as many times as needed. In general, SRAM cards are ideal for storing data files which may need to be frequently updated and/or deleted, since there is no restriction on the way in which, or the number of times, data can be deleted. Note that SRAM cards are available from a number of different manufacturers though the basic method of usage is always the same.

SRAM Card Beep Codes

When you insert any kind of PCMCIA card into a socket you will hear an audible beep which will inform you of the status of the card. All PCMCIA cards have two types of audible message that tell you about the status of your card and your system:

Single low pitched beep = Card not inserted properly, defective card, software improperly installed or, for SRAM cards, low battery

Two high-pitched beeps (second has higher pitch than first) = Hardware and software is correctly installed and everything is working fine

Formatting SRAM Cards

SRAM cards can be formatted with the DOS File Allocation Table (FAT) just like floppy diskettes. To format SRAM cards, follow the instructions below:

1. Insert the SRAM card in the PCMCIA slot. You should hear the two high-pitched beeps to indicate that everything is working fine.
2. At the DOS prompt type:

```
C:\> FORMAT d:/U
```

where d: is the drive letter of the socket in which the card is inserted. You should add the /U (Unconditional) switch when formatting PCMCIA cards to ensure correct formatting.

3. Your SRAM card will be formatted and you may now proceed to copy data to the card.

Making SRAM Cards Bootable

Just like floppy disk drives, SRAM cards can be made bootable. To do this, simply add the /S switch to the FORMAT command to transfer the DOS system files to the SRAM card. Thus you should type:

```
C:\> FORMAT d:/U/S
```

where d: is the drive letter of the socket in which the card is inserted.

Note that you must transfer the system using the format command and **cannot** use the SYS command to transfer the system to a pre-formatted SRAM card as you can with a floppy diskette.

After transferring the system to the card with the FORMAT command, you must then copy the PC/104 PCMCIA Module drivers and the DOS files HIMEM.SYS and SETVER.EXE from your internal hard disk drive to the SRAM card. Create a CONFIG.SYS file on the card which loads the PC/104 PCMCIA Module drivers and includes the other statements necessary to load HIMEM.SYS and SETVER.EXE, and set DOS = HIGH with UMBs, as detailed in Chapter 3. If you do not do this, though you will be able to boot from the SRAM card, the PC/104 PCMCIA Module slots will not be activated for any other device since the drivers that are needed to enable the system to recognize PC/104 PCMCIA Module have not been loaded.

Deleting Data on an SRAM Card

You can copy data to and delete data from SRAM cards as many times as you want using the standard DOS COPY and DELETE commands. Since SRAM cards are formatted with the DOS FAT system, they function exactly like floppy diskettes and there is no restriction on deleting data from them.

Using Flash Memory Cards

Using the DOS File Allocation Table (FAT) is very rough and is not a very useful or efficient way of formatting Flash memory cards. Most users find that using specialized software (like **CardWizard**, **CardSoft**, **CardWorks**) or the **Flash File System (FFS)** is a much better way to format their cards.

Flash memory cards can be formatted to be both readable and writable. This is done by using using the MCFORMAT.EXE utility program that is provided with your PC/104 PCMCIA Module unit.

CardWizard includes specialty software called File Translation Layer (FTL) that can format Flash cards and make them readable and writable.

Flash Memory Card Beep Codes

The beep codes for Flash memory cards are the same as for SRAM cards:

Single low pitched beep = Card not inserted properly, defective card, software improperly installed or, for SRAM cards, low battery

Two high-pitched beeps (second has higher pitch than first) = Hardware and software is correctly installed and everything is working fine

Formatting Flash Memory Cards

The utility software that comes with your PC/104 PCMCIA Module unit includes File Translation Layer (FTL) software for formatting linear Flash cards. The following examples show the process of formatting linear Flash cards under DOS.

Flash memory cards can be formatted using MCFORMAT.EXE.

1. Insert the Flash card in the PCMCIA slot. You should hear the single tone audible beep to indicate the card is unformatted
2. At the DOS prompt type:

```
C:\CARDWIZ> MCFORMAT
```

Follow the prompts in MCFORMAT.EXE to format your Flash memory card.

```
PC Memory Card Formatter
(C) 1994-1995 INTEL Corporation
Copyright 1994-1995 SystemSoft Corp. All Rights Reserved.
Version 1.07(2413-03)F

MCFORMAT options

Choose one of the following:

1. Create and format a new partition
2. Format an existing partition
3. Erase a partition
4. Display partition information

Enter your choice.      [1]

To quit MCFORMAT, press [ESC]
```

Create and format a new partition.

<u>Drive</u>	<u>Beg address</u>	<u>End address</u>	<u>Type</u>	<u>Status</u>	<u>Size</u>
D	0	2097151	Free	Unformatted	2048 K

Which drive would you like to select?

Drive = d

Would you like to format entire card with FLASH(1) OR FTL(2)
(1/2)? [2]

Erasing Flash Memory Cards

If you cannot successfully complete formatting a Flash card, you must erase the Flash card and try again.

PC Memory Card Formatter
(C) 1994-1995 INTEL Corporation
Copyright 1994-1995 SystemSoft Corp. All Rights Reserved.
Version 1.07 (2413-03)F

MCFORMAT options

Choose one of the following:

1. Create and format a new partition.
2. Format an existing partition.
3. Erase a partition.
4. Display partition information.

Enter your choice. [3]

To quit MCFORMAT, press [ESC].

Erase a partition.

<u>Drive</u>	<u>Beg address</u>	<u>End address</u>	<u>Type</u>	<u>Status</u>	<u>Size</u>
D	0	2097151	Free	Unformatted	2048 K

Which drive would you like to select?

Drive = d

This command will erase drive D: entirely.

Do you want to continue(Y)/(N)? [Y]

Your Flash card will be formatted and you may now proceed to read and write data to the card.

Booting from Linear Flash Cards

PCM-3110B and PCM-3115B provide you with the capability to boot from linear Flash cards. Booting from a linear Flash requires the following:

- IBM PC compatible system
- PCM-3110B or PCM-3115B with system boot software loaded in its Flash EPROM
- A linear Flash card formatted with M-System's True FFS PCMCIA software

If you want to order PCMCIA card drives with the above functions, you must inform us prior to ordering and buy a BTRM-FMS BootROM chip. The following instructions will enable you to create a bootable PCMCIA device.

Using M-Systems PCMCIA Flash Disk - TrueFFS

The following instructions permit you to use M-System's TrueFFS software to format Flash memory cards and enable the auto-boot feature of the PCM-3110B and PCM-3115B models.

You must first set the jumpers on your PCM-3110B and PCM-3115B to enable the BootROM function. Consult the jumper settings in Chapter 2 Installation.

Installing M-Systems TrueFFS software

1. Insert the M-Systems TrueFFS installation diskette into your disk drive and make the disk drive active.
2. Type (we will assume that drive A contains the installation diskette)

```
A>install
```

3. The installation program will prompt you for information about your system. Press Enter to confirm each of the following questions:

```
Do you have a color display [Y]
Continue Installation? [Y]
Enter the source drive letter [A:]
Enter the destination drive letter [C:]
/WINDOW=D000
/DRIVE=C
/SIZE=4096
BOOT C:\
Exit
```

Make sure that the contents of your CONFIG.SYS file contains the following commands:

```
DEVICE=C :\PCICSS.COM
DEVICE=C:\TFFS.COM /WINDOW=D000 /DRIVE=C /
SIZE=4096
```

Formatting your Flash Card as a Bootable Flash Card

1. Insert a floppy disk into your A: FDD drive and type

```
FORMAT A: /S/U
```
2. Copy SYS.COM, ROMIMAGE.ROM, PCICSS.COM, TFFS.COM, TFORMAT.COM and CONFIG.SYS to this working floppy disk

3. Insure that the CONFIG.SYS file includes the following lines:

```
DEVICE=A:\PCICSS.COM  
DEVICE=A:\TFFS.COM /WINDOW=D000 /DRIVE=C /  
SIZE=4096
```

4. Reboot your system and run your BIOS setup. Disable the IDE hard disk drive. This is usually done by pressing the Delete key immediately after your computer boots. Change the boot-up sequence to A, C which is usually found in the BIOS features setup menu.
5. Insert the working floppy disk drive in drive A: and boot from your floppy disk.
6. Insert your Flash card into the PCMCIA module and format the Flash card by typing:

```
TFORMAT C: /USE:99 /S:A:\ROMIMAGE.ROM
```

7. Reboot your computer from A:
8. Type A:\SYS C: and press Enter
9. Reboot your system and run the BIOS setup. Enable the IDE hard disk drive by changing the drive boot-up sequence back to C, A.
10. Remove the working floppy disk from A:, reboot your system from the Flash card (Flash Card = C, IDE HDD = D)

Chapter 5.

USING I/O CARDS

Introduction

Unlike SRAM and Flash memory cards, I/O (Input/Output) cards are not used to store data but are actually devices to perform some special function. I/O devices are instruments that control incoming and outgoing data flow. Traditional I/O devices for desktop PCs come in the form of interface cards that are plugged into the slots on the mainboard of the computer and include such devices as network cards, modems and fax modems.

In order to support portable computers, which do not support the installation of interface cards, these devices were designed as PCMCIA cards which could be plugged into the standard PCMCIA slot used for memory cards. I/O PCMCIA cards are usually Type II cards, i.e. cards of 5mm thickness. In this chapter we explain how to use I/O PCMCIA cards with the PC/104 PCMCIA Module. Note that we do not deal with Type II solid state hard disk drive cards, which are explained in detail in the next chapter.

Note

Configuring PCMCIA cards used to be an arduous process that often required intensive troubleshooting. SystemSoft's Cardsoft / CardWizard / CardWorks software greatly simplifies configuration and setup. Consult the on-line help in these software programs for detailed information about configuration.

Generally speaking , configuring I/O cards requires two main steps:

1. Install the hardware driver
2. Set the COM port or I/O address and IRQ settings

I/O Card Beep Codes

Just as with memory cards, when an I/O card is inserted in the PC/104 PCMCIA Module slot, an audible beep is issued to inform you of the status of the card. There are two kinds of audible message with I/O cards, which is:

Single low pitched beep = Card not inserted properly, defective card, software improperly installed or, for SRAM cards, low battery

Two high-pitched beeps (second has higher pitch than first) = Hardware and software is correctly installed and everything is working fine

PCMCIA I/O Card Types

As we have mentioned, there are a number of different types of PCMCIA I/O cards and the key points regarding their use with PC/104 PCMCIA Module are given here. Note, that in order to be able to use PCMCIA I/O cards, you must have installed the PC/104 PCMCIA Module drivers as detailed in Chapter 3. Although this type of PCMCIA card is not used to store data, and therefore requires no formatting, the PC/104 PCMCIA Module drivers must have been correctly installed in order to allow your system to recognize the PC/104 PCMCIA Module slot.

Modem and Fax/Modem Cards

Automatic COM Port Assignment

When installing an internal or external serial modem or fax modem, the device must be assigned a COM port. PCMCIA modems and fax modems are no different, and the correct COM port must be assigned in order for the devices to function correctly.

When you insert a modem or fax/modem in a PC/104 PCMCIA Module slot, the following COM port assignments are made:

- If no COM port is being used, the PCMCIA modem is automatically assigned to COM 1.
- If COM 1 is being used, the PCMCIA modem is automatically assigned to COM 2.
- If COM 1 & COM 2 are being used, the PCMCIA modem is automatically assigned to COM 3.

If for example, you have a mouse connected to COM 1 and you insert a PCMCIA modem card in Socket 1 or Socket 2, the modem is automatically assigned to COM2. Although the hardware COM port assignment is automatic, in your communication software, you must specify that your communication device is connected to COM2.

PCMCIA Network Cards

After fax/modem and modem cards, the most commonly available PCMCIA I/O device is a Local Area Network (LAN) card, which allows your system to be hooked into a network. The PC/104 PCMCIA Module hardware and software is fully compatible with most popular PCMCIA LAN cards, including those from IBM, National Semiconductor (NS) and D-Link, Accton, Svec and Socket Communications Inc.'s Socket EA card. These cards can be used with PC/104 PCMCIA Module with no further configuration. Intel's Ethernet card can also be used, though please note the section below on using Intel's PCMCIA Ethernet Card.

Using Intel's PCMCIA Ethernet Card

If you wish to use Intel's PCMCIA ethernet card, it is necessary to make certain adjustments to ensure correct operation. Intel's PCMCIA card comes with a complete software package which is installed on the hard disk drive. The Intel installation program will modify your CONFIG.SYS file and your AUTOEXEC.BAT files. The following statements are added to the AUTOEXEC.BAT file:

```
C:\CARDMGR\CCMGR.EXE
C:\INTELAN\LSL.COM
C:\INTELAN\INTEL595.COM
C:\INTELAN\IPXODI.COM
C:\INTELAN\NETX.EXE
```

No change need to be made to these statements.

The following statements will be added to the CONFIG.SYS file by SystemSoft CardSoft:

```
DEVICE=C:\CARDSOFT\SSVADEM.EXE
(Socket Services Driver)
DEVICE=C:\CARDSOFT\CS.EXE
(Card Services Driver)
DEVICE=C:\CARDSOFT\CSALLOC.EXE
DEVICE=C:\CARDSOFT\CARDID.EXE
```

The first thing you must do is check that the above statements appear **after** the statements used to load the PC/104 PCMCIA Module drivers which are detailed on page 3-5. If they do not, use any text editor to edit your CONFIG.SYS file and move the statements below the PC/104 PCMCIA Module statements.

The first two statements load SystemSoft's Socket services and Card Services software drivers which are used by Intel. Because your PC/104 PCMCIA Module software already provides its own socket services and card services drivers these statements should be removed or disabled to prevent conflict. To disable these two statements, simply add the REM (remark) statement in front of them.

To do this, use any text editor to call up the CONFIG.SYS file and edit the statements as below:

```
REM DEVICE=C:\CARDSOFT\SSVADEM.EXE  
REM DEVICE=C:\CARDSOFT\CS.EXE
```

Adding the REM statement will disable these two lines. You could also delete these two statements completely, though adding REM ensures they are still there for reference in case you need to use them in the future.

Disabling these two statements will ensure that your Intel PCMCIA Ethernet card will function perfectly with PC/104 PCMCIA Module and you can use all the other features. Note that if you delete the PC/104 PCMCIA Module socket services and card services drivers and use those provided with Intel's software, you will be able to use your Intel card but will not be able to access the second PCMCIA slot or use any other device.

PCMCIA LAN Card Software in General

Due to the complicated nature of LAN card configuration, most PCMCIA LAN cards come with their own software. It will usually be advisable to run this software to make sure you have the full range of configuration options available. In addition to allowing you to configure the LAN card, most PCMCIA LAN card software includes a complete set of PCMCIA drivers which may be installed in the CONFIG.SYS file in place of the PC/104 PCMCIA Module drivers. Since some LAN cards are not designed totally according to the PCMCIA standards and include proprietary technology, it may be the case that such cards will run better if the drivers provided with the card are installed.

Note that the PC/104 PCMCIA Module hardware fully supports PCMCIA drivers from third parties.

Chapter 6.

USING ATA DISK DRIVE CARDS

Introduction

PCMCIA ATA hard disk drives represent a major technological breakthrough in terms of portability and exchangeability of large amounts of data. Two main types are available: solid-state devices such as the Sundisk ATA card which is a Type II device and rotating media ATA hard disk drive cards which are Type III devices. Both types are supported by all models of PC/104 PCMCIA Module. Both types of devices function in the same way and all instructions in this chapter apply to both types.

These devices make large capacity hard disk drives as convenient to use as floppy diskettes. With PC/104 PCMCIA Module installed on your desktop, you have instant access to the ATA hard disk drive you use in your notebook. This will save you hours in wasted time copying data to diskettes to transfer data between your portable computer and your desktop, and provides an easy way to install a second hard disk drive without having to open up your system and mess around with cables and connectors.

The PC/104 PCMCIA Module sockets provide full support for all brands of ATA hard disk drives, including the ability to boot from such devices. If you already have two hard disk drives installed on your system, with PC/104 PCMCIA Module models you can expand your system to three or four hard disk drives.

ATA Hard Disk Drive Beep Codes

Just as with memory cards and I/O cards, when an ATA HDD card is inserted in the PC/104 PCMCIA Module slot, an audible beep is issued to inform you of the status of the card.

Single low pitched beep = Card not inserted properly, defective card, software improperly installed or, for SRAM cards, low battery

Two high-pitched beeps (second has higher pitch than first) = Hardware and software is correctly installed and everything is working fine

This signal tells you that the ATA card is working correctly. If you fail to hear this beep signal when you insert the card, this may indicate that the card is faulty or damaged.

ATA HDD Drive Letter Assignments (Non bootable)

The drive letter assigned to an ATA HDD card will depend on the configuration of your system. The basic rules for drive letter assignment are:

The first two drive letters above those existing on the system are reserved for memory cards in Socket 1 and Socket 2. The next four drive letters are reserved for an ATA HDD in Socket 1 and an ATA HDD card in Socket 2.

In order to make this understandable, it is best to take some actual examples to illustrate the driver letter assignments when using **Cardsoft/Cardworks/Cardwizard** software.

Example 1

If your system has two floppy drives and one hard disk drive formatted into two partitions, the drive letter assignments when running **Cardsoft 3.1** will be as follows:

- Floppy disk drive 1 - A: (no change)
- Floppy disk drive 2 - B: (no change)
- Internal hard disk drive partition 1 - C: (no change)
- Internal hard disk drive partition 2 - D: (no change)
- ATA HDD/ATA Flash card in PC/104 PCMCIA Module Socket 1-E:
- ATA HDD/ATA Flash card in PC/104 PCMCIA Module Socket 2- F:
- Memory card in PC/104 PCMCIA Module Socket 1 - G:
- Memory card in PC/104 PCMCIA Module Socket 2 - H:

Example 2

If your system has two floppy drives and two hard disk drives both formatted into two partitions, the drive letter assignment when running **CardSoft 3.1** will be as follows:

- Floppy disk drive 1 - A: (no change)
- Floppy disk drive 2 - B: (no change)
- Internal hard disk drive 1 partition 1 - C: (no change)
- Internal hard disk drive 2 partition 1 - D: (no change)
- Internal hard disk drive 1 partition 2 - E: (no change)
- Internal hard disk drive 2 partition 2 - F: (no change)
- ATA HDD/ATA Flash card in PC/104 PCMCIA Module Socket 1-G:
- ATA HDD/ATA Flash card in PC/104 PCMCIA Module Socket 2- H:
- Memory card in PC/104 PCMCIA Module Socket 1 - I:
- Memory card in PC/104 PCMCIA Module Socket 2 - J:

Example 3

If your system has two floppy disk drives (A and B) and one hard disk drive with a single partition (C), the drive letter assignments for your PC/104 PCMCIA Module drives under **Cardsoft 3.1** will be the following:

- ATA HDD/ATA Flash card in PC/104 PCMCIA Module Socket 1- D:
- ATA HDD/ATA Flash card in PC/104 PCMCIA Module Socket 2-E:
- SRAM/Flash card in PC/104 PCMCIA Module Socket 1 - F:
- SRAM/Flash card in PC/104 PCMCIA Module Socket 2 - G:

Example 4

If your system has two floppy disk drives (A and B) and one hard disk drive with a single partition (C), the drive letter assignments for your PC/104 PCMCIA Module drives under **Cardwizard** will be the following:

- All cards in PC/104 PCMCIA Module Socket 1 - D:
- All cards in PC/104 PCMCIA Module Socket 2 - E:

Making ATA HDD/Flash Cards Bootable

The PC/104 PCMCIA Module hardware includes a Boot ROM which allows you to boot from both memory cards and ATA hard disk drive cards. The procedure for making memory cards bootable is carried out using the standard DOS FORMAT /U/S command, as detailed in Chapter 4.

The step-by-step procedure for making ATA HDDs bootable with **Cardsoft 3.1** or **Cardwizard** is as follows:

1. Run **Cardsoft/Cardwizard** PCMCIA software.
2. Insert your ATA HDD/ATA Flash card into your PC/104 PCMCIA Module socket.
3. **Cardsoft/Cardwizard** will analyze your card upon the first insertion and return the number of cylinders, heads, sectors and tracks.
4. Run ATAINIT.EXE. The software will display the following:

```
SystemSoft ATAINIT Utility Version 1.12 (2178-14)
Copyright 1992-1995 SystemSoft Corporation. All Rights Reserved
Hit <ESC> or <Q> to exit or <F1> for help.

What letter do you want to init?
```

Choose D for the first PCMCIA socket, or E for the second socket.

5. ATAINIT.EXE performs a scan of your card and returns the same information that was presented in step 3.

```
Fixed Cylinders: 1008
                Heads: 15          <F1> - Help
Physical Sectors/track: 17      <ESC> - Quit
```

Here are the parameters that were returned, examine them carefully to insure they match what was expected.

Hit ENTER to accept and continue or <P> to prompt. [ENTER]

6. ATAINIT.EXE will display the following message:

```
Do you want a compact format?
```

Enter Yes and ATAINIT.EXE will wipe the BPB boot sector

7. At the DOS prompt, type:

```
FORMAT E:/S/U OR FORMAT D:/S/U
```

8. You should now copy the PC/104 PCMCIA Module drivers and the DOS files HIMEM.SYS and SETVER.EXE from your internal hard disk drive to the ATA drive. Create a CONFIG.SYS file on the drive which loads the PC/104 PCMCIA Module drivers and includes the other statements necessary to load HIMEM.SYS and SETVER.EXE, and set DOS = HIGH with UMBs, as detailed in Chapter 3. If you do not do this, though you will be able to boot from the ATA drive, the PC/104 PCMCIA Module slots will not be activated for any other device since the drivers that are needed to enable the system to recognize PC/104 PCMCIA Module have not been loaded.

Note

When using an ATA HDD or ATA Flash card with Boot ROM v.2.0x, the size of the card determines whether it boots as drive A or drive C. If the card is less than 15 MB, it will boot as drive A and the floppy disk will become B; if greater than 15 MB it will boot as drive C and your hard drive will become D. This means that Flash cards (which are typically less than 15 MB) will boot as A, and ATA HDD cards (typically greater than 15 MB) will boot as drive C.

Reboot your system and run the BIOS setup. An ATA disk drive card that is less than 15 MB will be designated as drive A:. Change the boot-up sequence to A, C which is usually found in the BIOS features setup menu.

If you need to recover your floppy disk drive as A, simply remove the PCMCIA card from its slot and type DIR A:. The floppy drive will then reassigned as drive A.

Bootable ATA Flash Card Letter Assignments

If you boot from an ATA Flash card the drive letter assignment of your entire system is changed. After boot up, the bootable drive will become the A: drive, as shown by the A> DOS prompt.

In this case the original A: floppy disk drive becomes the B: drive. If you have a second floppy disk drive on your system, this will be inaccessible. To rearrange the entire drive letter assignment back to normal and have access to the second floppy drive, proceed as follows:

1. Boot up from the ATA Flash card.
2. Disconnect the ATA Flash card by pulling it halfway out of the socket.
3. Insert any floppy diskette in the A: floppy disk drive.
4. At the DOS prompt, type A>DIR. The A: directory of the A: floppy disk drive will be displayed.
5. The A: floppy is now restored as A: and the B: floppy can be accessed on B: as normal. All other drive letter assignments are as described in the section above.
6. Re-insert the ATA Flash card in the socket.

Note

If ATA Flash card has been configured with the **CardWizard** driver software, the letter assignments will be the following:

First slot: A: drive becomes D: drive

Second slot: A: drive becomes E: drive

If you did not install the CardWizard driver software, the letter assignments will be as follows:

ATA Flash cards \leq 15 MB: A:

ATA Flash cards \geq 15 MB: C:

Appendix A

PC/104 PCMCIA Module Pin Assignments

PC/104 Bus Connectors (PCM-3110, 3110B, 3111, 3115B)

The PC/104 PCMCIA Module PCM-3110, PCM-3111, PCM3115B and PCM-3110B all feature PC/104 bus connectors. These two connectors replace the “golden finger” edge connectors that are found on ISA or PCI-bus devices. The PC/104 connectors appear as follows:

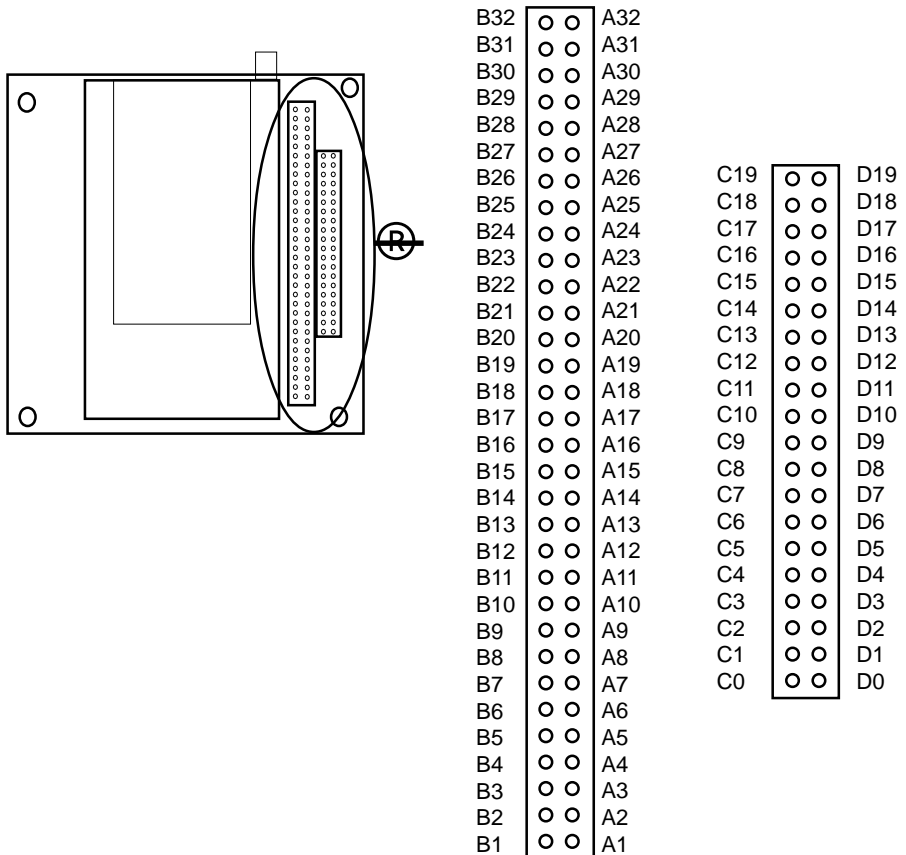

PC/104 Connectors

Pin Number	Connector J1		Connector J2	
	RowA	RowB	RowC	RowD
0	—	—	GND	GND
1	IOCK#	GND	SBHE#	MEM16
2	SD7	RESETDRV	LA23	IO16#
3	SD6	+5V	LA22	IRQ10
4	SD5	IRQ9	LA21	IRQ11
5	SD4	-5V	LA20	IRQ12
6	SD3	DRQ2	LA19	IRQ15
7	SD2	-12V	LA18	IRQ14
8	SD1	OWS#	LA17	DACK0#
9	SD0	+12V	MEMR#	DRQ0
10	IOCHRDY	GND	MEMW#	DACK5#
11	AEN	SMEMW#	SD8	DRQ5
12	SA19	SMEMR#	SD9	DACK6#
13	SA18	IOW#	SD10	DRQ6
14	SA17	IOR#	SD11	DACK7#
15	SA16	DACK3#	SD12	DRQ7
16	SA15	DRQ3	SD13	+5V
17	SA14	DACK1#	SD14	MASTER#
18	SA13	DRQ1	SD15	GND
19	SA12	REFRESH#	—	GND
20	SA11	ATCLK#	—	—
21	SA10	IRQ7	—	—
22	SA9	IRQ6	—	—
23	SA8	IRQ5	—	—
24	SA7	IRQ4	—	—
25	SA6	IRQ3	—	—
26	SA5	DACK2#	—	—
27	SA4	T/C	—	—
28	SA3	BALE	—	—
29	SA2	+5V	—	—
30	SA1	OSC	—	—
31	SA0	GND	—	—
32	GND	GND	—	—

80-Pin Flat Cable (PCM-3110 and PCM-3111)

The PCM-3110 and PCM-3111 are connected together by using an 80-pin flat cable. When making the connection, make sure that pin 1 on PCM-3110 is connected to pin 1 on PCM-3111.

A40	○ ○	B40
A39	○ ○	B39
A38	○ ○	B38
A37	○ ○	B37
A36	○ ○	B36
A35	○ ○	B35
A34	○ ○	B34
A33	○ ○	B33
A32	○ ○	B32
A31	○ ○	B31
A30	○ ○	B30
A29	○ ○	B29
A28	○ ○	B28
A27	○ ○	B27
A26	○ ○	B26
A25	○ ○	B25
A24	○ ○	B24
A23	○ ○	B23
A22	○ ○	B22
A21	○ ○	B21
A20	○ ○	B20
A19	○ ○	B19
A18	○ ○	B18
A17	○ ○	B17
A16	○ ○	B16
A15	○ ○	B15
A14	○ ○	B14
A13	○ ○	B13
A12	○ ○	B12
A11	○ ○	B11
A10	○ ○	B10
A9	○ ○	B9
A8	○ ○	B8
A7	○ ○	B7
A6	○ ○	B6
A5	○ ○	B5
A4	○ ○	B4
A3	○ ○	B3
A2	○ ○	B2
A1	○ ○	B1

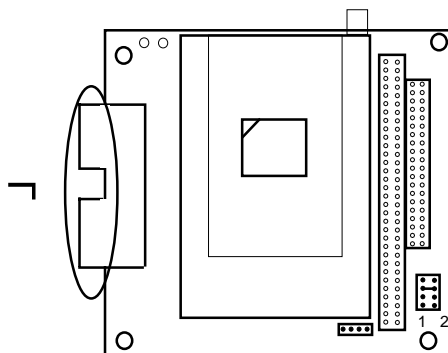

80-Pin Flat Cable Connectors

Pin No.	Function	Pin No.	Function
A1	VPPB	B1	VCC
A2	VPPB	B2	VCC
A3	VPPB	B3	VCC
A4	GND	B4	VCC
A5	B-CA12	B5	GND
A6	B-CA25	B6	SD0
A7	B-CA13	B7	SD15
A8	B-CA24	B8	SD1
A9	B-CA14	B9	SD14
A10	GND	B10	GND
A11	B-CA23	B11	SD2
A12	B-CA15	B12	SD13
A13	B-CA22	B13	SD3
A14	B-CA16	B14	SD12
A15	B-CA21	B15	GND
A16	GND	B16	SD4
A17	B-CA17	B17	SD11
A18	B-CA20	B18	SD5
A19	B-CA18	B19	SD10
A20	B-CA19	B20	GND
A21	GND	B21	SD6
A22	SA0	B22	SD9
A23	SA1	B23	SD7
A24	SA2	B24	SD8
A25	SA3	B25	GND
A26	GND	B26	B-*CE1
A27	SA4	B27	B-*OE
A28	SA5	B28	B-*IORD
A29	SA6	B29	B-*REG
A30	SA7	B30	GND
A31	GND	B31	B-*IOWR
A32	SA8	B32	B-*WE
A33	SA9	B33	B-*CE2
A34	SA10	B34	B-RESET
A25	SA11	B35	GND
A36	GED	B36	B-WP
A37	B-*ENABLE	B37	B-BVD2
A38	EXTDIR	B38	B-*CD2
A39	B-*CD1	B39	B-*WAIT
A40	B-BVD1	B40	B-RDY

2x50-Pin Connectors (PCM-3110B, PCM-3113, PCM-3114)

The PCM-3113 and PCM-3114 provides an additional PCMCIA drive with a 3.5" FDD form factor for customers that have purchased a PCM-3110B. The PCM-3114 also provides a 3.5" FDD drive. Connections with the PCM-3110B are made with 2 x 50-pin flat cables.

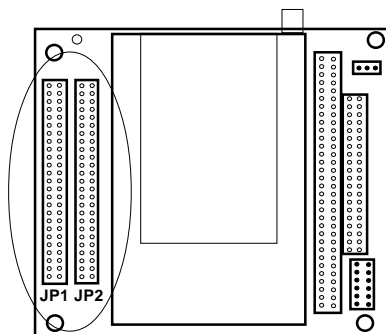
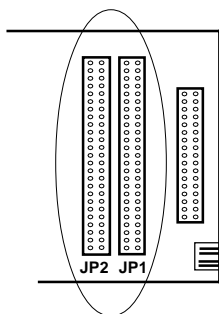

JP1		JP2	
50	○ ○	49	○ ○
48	○ ○	47	○ ○
46	○ ○	45	○ ○
44	○ ○	43	○ ○
42	○ ○	41	○ ○
40	○ ○	39	○ ○
38	○ ○	37	○ ○
36	○ ○	35	○ ○
34	○ ○	33	○ ○
32	○ ○	31	○ ○
30	○ ○	29	○ ○
28	○ ○	27	○ ○
26	○ ○	25	○ ○
24	○ ○	23	○ ○
22	○ ○	21	○ ○
20	○ ○	19	○ ○
18	○ ○	17	○ ○
16	○ ○	15	○ ○
14	○ ○	13	○ ○
12	○ ○	11	○ ○
10	○ ○	9	○ ○
8	○ ○	7	○ ○
6	○ ○	5	○ ○
4	○ ○	3	○ ○
2	○ ○	1	○ ○

2 x 50-Pin Flat Cable Connectors

Connector JP1

Pin No.	Function	Pin No.	Function
1	GND	2	A0
3	A1	4	A2
5	A3	6	GND
7	A4	8	A5
9	A6	10	A7
11	GND	12	A8
13	A9	14	A10
15	A11	16	GND
17	GND	18	B-CA12
19	B-CA13	20	B-CA14
21	B-CA15	22	GND
23	B-CA16	24	B-CA17
25	B-CA18	26	B-CA19
27	GND	28	B-CA20
29	B-CA21	30	B-CA22
31	B-CA23	32	GND
33	B-CA24	34	B-CA25
35	GND	36	GND
37	B-*ENABLE	38	EXTDIR
39	GND	40	GND
41	VCC	42	VCC
43	VCC	44	VCC
45	GND	46	GND
47	VPPB	48	VPPB
49	VPPB	50	VPPB

Connector JP2

Pin No.	Function	Pin No.	Function
1	GND	2	D0
3	D1	4	GND
5	D2	6	D3
7	GND	8	D4
9	D5	10	GND
11	D6	12	D7
13	GND	14	D8
15	D9	16	GND
17	D10	18	D11
19	GND	20	D12
21	D13	22	GND
23	D14	24	D15
25	GND	26	GND
27	B-*WAIT	28	B-*CD1
29	B-*CD2	30	B-BVD1
31	B-BVD2	32	B-WP
33	B-RDY/*BSY	34	GND
35	B-*IORD	36	B-*IOWR
37	B-*WE/PRGM	38	B-*OE
39	GND	40	B/*REG
41	B-*CE1	42	B-*CE2
43	B-RESET	44	LEDB
45	GND	46	GND
47	VCC	48	VCC
49	VCC	50	VCC

FDD Cable and FDD Power connector (PCM-3114)

The PCM-3114 combination 3.5" FDD/PCMCIA drive includes a 34-pin FDD cable and a 4-pin mini power connector for the 3.5" FDD. Connect the FDD cable to your computer's main board and the power connector to your computer's power supply.

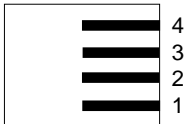
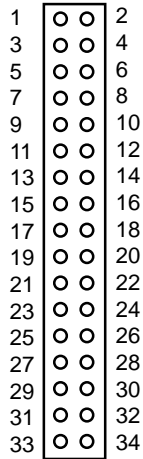
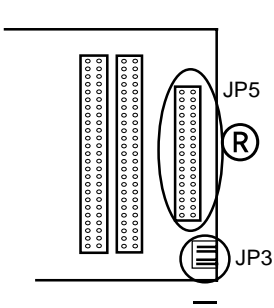

Floppy drive connector

Connector JP5

Pin	Signal	Pin	Signal
1	GND	2	DENSITY SELECT
3	GND	4	N/C
5	GND	6	N/C
7	GND	8	INDEX
9	GND	10	MOTOR 0
11	GND	12	DRIVE SELECT 1
13	GND	14	DRIVE SELECT 0
15	GND	16	MOTOR 1
17	GND	18	DIRECTION
19	GND	20	STEP
21	GND	22	WRITE DATA
23	GND	24	WRITE GATE
25	GND	26	TRACK 0
27	GND	28	WRITE PROTECT
29	GND	30	READ DATA
31	GND	32	HEAD SELECT
33	GND	34	DISK CHANGE

Power Connector

Connector JP3

Pin	Signal	Pin	Signal
1	12V	2	GND
3	GND	4	5V

Preface

INTRODUCING PCMCIA CARDS

Introduction

If you are unfamiliar with PCMCIA cards, then we suggest you read this preface to gain an overall understanding of the various types and configurations before you attempt to install your PC/104 PCMCIA Module. If you have used PCMCIA cards before, it is not necessary to read this section and you should proceed directly to the main body of the manual.

What are PCMCIA Cards?

PCMCIA stands for the Personal Computer Memory Card International Association, an organization which sets the technical standards according which all related devices are designed. PCMCIA cards (also known as PC cards, and incorrectly, as IC cards) are rapidly replacing floppy diskettes as the storage medium of choice for computer users. They are small, compact, have a large capacity and offer a flexible range of options for both storage of data and implementation of devices.

PCMCIA cards come in 3 thicknesses (all of them have the same length and width dimensions):

- Type I cards are 3.3 mm thick
- Type II cards are 5 mm thick
- Type III cards are 10.5 mm thick

Though the Type number refers to the thickness of the card rather than to its function, the cards available in each category generally fall into the following three groups:

Type I Cards

Memory cards for storing data. These include two main types - SRAM memory cards and Flash memory cards.

Type II Cards

Type II cards are I/O cards including modem cards, fax/modem cards, Ethernet LAN cards and solid-state ATA hard disk drive cards.

Type III Cards

Type III cards are ATA hard disk drive cards with rotating media.

The PC/104 PCMCIA Module series of products supports some or all of these card types depending on the model.

SRAM and Flash Memory Cards

As we have mentioned, there are two types of memory cards; SRAM and Flash. These types are not interchangeable but both can be used as data storage devices. Note that although SRAM cards are generally Type I devices, Flash memory cards may be either Type I or II, depending on their density. The difference between these two types is as follows:

- SRAM cards can be used to store and load data. Data on these cards can be written and erased many times just like the data on a floppy diskette. SRAM cards can also be made bootable.
- Flash cards can be used to store and load data. Depending on the formatting process used, Flash cards are either WORM (Write Once Read Many times) or full read/write. These cards can also be made bootable.

PCMCIA Memory Card Formatting Options

Memory cards can be formatted with either SystemSoft's Flash Translation Layer (FTL), M-System's True Flash File System (TFFS) or with the DOS File Allocation Table (FAT).

Formatting SRAM Cards

The FAT System is the same as that used by standard floppy diskettes and hard disks and provides a straight forward option for uncomplicated formatting. SRAM cards should always be formatted with the FAT system which will allow them to be used in exactly the same way as floppy diskettes with full read/write capability.

Formatting Flash Cards

For Flash memory cards, the formatting choice depends on the usage intended for the Flash card, and also whether you intend to use the card on some other system, since not all systems support all formats. Flash cards can be formatted using the standard DOS FAT system but this has the disadvantage that they become WORM (Write Once Read Many times) devices.

SystemSoft's Flash Translation Layer (FTL) and M-Systems True Flash File System (TFFS) are special purpose software that organize the data on a Flash card allowing you to use a Flash card in much the same way as a SRAM card. Any application can write data to a Flash card prepared with FTL or TFSS just as easily as writing to a diskette.

You will have to purchase FTL software and/or TFSS software before you will be able to format cards in these formats and read cards already formatted with FTL or TFSS.

What is PC/104?

Introduction

The PC/104 standard is a compact version of the IEEE P996 (PC and PC/AT) bus. The specifications were drafted for the unique requirements of embedded systems and PC/104 is gaining wide acceptance in the field of industrial computing. There are 104 signal contacts on the two PC/104 bus connectors: P1 has 64 pins and P2 has 40 pins

Advantages of PC/104

PC/104 has several advantages over conventional, i.e. ISA/VESA/PCI, bus systems:

- A self-stacking bus eliminates the need for backplanes and card cages
- The 40 and 64-pin connectors are durable and replace typical PC edge connectors
- A small form factor of 3.55" x 3.775" (90.17 mm x 95.89 mm)
- Lower bus drive requirements (6 mA) lowers power consumption to 1~2 watts per card

PC/104 acts as the bridge for using PC technology in industrial applications. It enables system integrators to capitalize on a wide variety of standard PC hardware and software in designing their embedded systems.