

VTX-6071

PC/104 Embedded Vortex86™ CPU Module

128MB/4S/2USB/CRT/LCD/Audio/LAN

User's Manual

(Revision 1.0)

● **Copyright**

The information in this manual is subject to change without notice for continuous improvement in the product. All rights are reserved. The manufacturer assumes no responsibility for any inaccuracies that may be contained in this document. And makes no commitment to update or to keep current the information contained in this manual.

No part of this manual may be reproduced, copied, translated or transmitted, in whole or in part, in any form or by any means without the prior written permission of the manufacturer.

©Copyright 2002

Manual No. IUM6071000-01 Ver. 1.0 All rights reserved.

● 1st issue date: July 31, 2003

● **Trademarks Acknowledgment**

Other brand names or product names appearing in this document are the properties and registered trademarks of their respective owners. All names mentioned herewith are served for identification purpose only.

Table of Contents

Table of Contents	iii
Chapter 0 Startup	1
0.1 Packing List.....	1
0.2 Option Accessory	1
0.3 Specification	2
Chapter 1 Introduction	5
1.1 Features	5
1.2 Specifications.....	6
1.3 VGA Interface	7
1.4 Audio Interface	7
1.5 Network Interface	7
Chapter 2 Installation	8
2.1 Board Outline	8
2.1.1 By Function	8
2.1.2 By Location	9
2.2 Connectors & Jumpers Summary	10
2.3 Pin Assignments & Jumper Settings	111
J1 : VGA Connector	11
J2 : RESET	11
J3 : USB Connector	11
J4 : PS/2 Keyboard Connection.....	11
J6 : Speaker	12
J7 : PS/2 Mouse Connection	12
J8 : LCD Connector	13
J5 : LCD Volts Selection	13
J9 : LAN Connection	14
J10 : IDE Connector	14
J11 : Power Connector	15
J12 : CPU FAN	15

J13 : RS232/RS485 Select	15
J14 : FDD Connector	16
J15 : COM1 Connection	16
J16 : COM2 Connection	17
J17 : Printer Connector	17
J18 : RS485 Connection	17
J19 : PC/104 Connector	178
J20 : PC/104 Connector	18
J21 : Line-in Connector	19
J22 : Line-out Connector	20
J23 : Mic-in Connector	20
J24 : COM3 Connection	20
J25 : COM4 Connection	20
2.4 Watchdog Timer	21
Chapter 3 SVGA Setup	25
3.1 Introduction	25
3.1.1 SoC Chipset	25
3.1.2 Display memory	25
3.2 Flat Panel BIOS Wiring	26
Chapter 4 Network Interface	30
4.1 Introduction	30
4.2 Software Support	30
Warranty	31

Chapter 0

Startup

Packing List

Product Name	Function	Package
VTX-6071	PC/104 Embedded Vortex86™ CPU Module	<ul style="list-style-type: none">● VTX-6071 PC/104 Embedded Vortex86™ CPU Module● Manual & Drivers CD x 1 (Optional)● FDD cable x 1● HDD cable x 1● VGA cable x 1● LAN cable x 1● USB cable x 1● Audio cable x 3● RS232 cable x 4● Printer cable x 1● PS2 cable for Keyboard and Mouse x 2

0.3 Specification

Features	VTX-6071
Processor Chipset	DM&P(SiS)Vortex86™ System-on-Chip CPU-200MHz Real Time Clock with Lithium Battery Backup
Bus Interface	PC/104 Standard Compliant
Memory	Onboard 128MB SDRAM
BIOS	AMI BIOS
Multi I/O	<ul style="list-style-type: none"> ● Enhanced IDE interface ● RS232 port x3 ● RS232/485 port x1 ● Parallel port x1 ● FDD interface x1 ● USB port x1 ● Line-in port x1 ● Line-out port x1 ● Mic-in port x1
Video Display	<ul style="list-style-type: none"> ● AGP Rev.2.0 Compliant ● Shared system memory area up to 16MB. ● Resolution up to 1,920Cx 1,440 true colors ● CRT/LCD display
LAN	<ul style="list-style-type: none"> ● Realtek 8100B single chip ● Full-duplex transfer mode, doubles effective bandwidth 16KB RAM buffer ● Throughput 10/100Mbps

Connectors	<ul style="list-style-type: none"> ● 2.0mm 44-pin box header for IDE ● 2.0mm 10-pin box header for RS-232 x3 ● 2 pin header for RS-485 ● 2.0mm 26-pin box header for Printer ● 2.0mm 34-pin box header for FDD ● 2.0mm 10-pin box header for USB ● 2.0mm 10-pin box header for VGA ● 2.0mm 8-pin header for Ethernet ● 2.0mm 44-pin box header for LCD connector ● 2.0mm 4-pin header for Line-in ● 2.0mm 4-pin header for Line-out ● 2.0mm 4-pin header for Mic-in ● 5-pin box header for AT-Keyboard connector ● 5-pin header for PS/2 Mouse
Watchdog Timer	<ul style="list-style-type: none"> ● Software Watchdog Timer ● Three 8254 Compatible Programmable 16-bit Counters.
Power Requirement	Single Voltage +5V @1.2 A
Board Weight	100g
Board Size	90mm X 96mm
Operating Temperature	-20°C ~ +70°C

This page is intentionally left blank.

Chapter 1

Introduction

1.1 Features

- PC/104 Embedded *Vortex86™* CPU Module (90 x 96 mm)
- DM&P *Vortex86™* System-On-Chip
- CRT and Flat Panel Display interface
- Onboard 128MB SDRAM
- Enhanced IDE devices and FDD interface
- One Bi-directional Parallel Port
- RS-232/485 interface
- Watchdog timer
- Onboard Keyboard & Mouse connector
- Onboard Audio connector
- Onboard Ethernet
- Single voltage +5V power connector
- Operating temperature from $-20^{\circ}\text{C} \sim +70^{\circ}\text{C}$
- Board Support Package for Windows CE.NET
- Accept custom modification

1.2 Specifications

- **Embedded CPU:** DM&P *Vortex86™* System-on-Chip CPU – 200MHz, Realtime clock, and watchdog timer.
- **BIOS:** Y2K compliant AMI system BIOS
- **System Memory:** Onboard 128MB SDRAM
- **Bus Interface:** PC/104 ISA Bus Interface
- **Data Bus:** 64-bit
- **Bus Speeds:** PCI Bus – 33MHz
- **DMA Channels:** 7
- **Interrupt Levels:** 15
- **Enhanced IDE:** supports one port and up to two hard drives or Enhanced IDE devices of PIO mode 4. BIOS enabled/disabled
- **Watchdog Timer:** generates either a RESET, NMI or an IRQ when your application loses control over the system. Optionally the watchdog can trigger a user specified interrupt.
- **Real-time Clock:** included in *Vortex86™* SOC with onboard lithium battery backup. CMOS data backup of BIOS setup and BIOS default.
- **Keyboard and Mouse Connectors:** supports PS/2 Keyboard and mouse
- **Serial ports:** Supports high speed RS-232 port, high speed RS-232/485 port (jumper selectable).
- **Floppy Disk Drive Interface:** supports up to two floppy drives, 5¼" (360 KB or 1.2 MB) and 3½" (720 KB, 1.44 MB). BIOS enabled / disabled
- **Bi-directional Parallel Port:** supports SPP, EPP and ECP mode. BIOS enabled/disabled
- **Audio port:** AC97 CODEC, includes line-in, line out, mic-in functions.
- **Power Requirements:** single voltage +5 V @ 1.2A
- **Board Dimensions:** 90 (L) x 96 (W) mm.
- **Board Weight:** 100 g
- **Extended Operating Temperature:** -20°C ~+70 °C

1.3 VGA Interface

- **Chipset:** DM&P *Vortex86™* SOC
- **Memory:** Shared system memory up to 128MB
- **System Bus:** 33-bit PCI bus
- **Panel Data Bus:** 24-bit
- **Display:** CRT and LCD Flat Panel
- **Compliance:**
 - AGP 2.0 / 4X Compliant / Fully DirectX 8 Compliant
 - Cooperates with "Video Bridge" to support Digital LCD/CRT Monitor
- **Digital Output:**
 - Supports VESA Standard Super High Resolution Graphic Modes
- **Supported Flat Panels:**
 - PVI 6.4" TFT LCD panel P/N: V16C6448AC
 - SHARP 6.4" TFT LCD panel P/N: LQ64D341 (HIROSE DF9BA-31P-1V)
 - NEC 6.5" TFT Color LCD panel P/N: NL6448BC20-08 (HIROSE DF9B-31P-1V)
 - AU 8.4" LVDS Color LCD panel P/N: B084SN01
 - AU 10.4" LVDS Color LCD panel P/N: B104SN01
 - AU 13.3" LVDS Color LCD panel P/N: UB133X01

1.4 Audio Interface

- **Chipset:** Realtek ALC202
- **Compliance:** AC97 CODEC
- **Support:** Line-in/Line-out/Mic out

1.5 Network Interface

- **Chipset:** Realtek 8100B single chip
- **Type:** 10/100BASE-T
- **Transfer Mode:** Full duplex, doubles effective bandwidth
- **Buffer:** Built-in 16KB RAM Buffer.
- **Connectors:** 8-pin male header, pitch 2.0mm
- **Monitoring LEDs:** network ready indicator, network activity indicator

Chapter 2

Installation

2.1 Board Outline

2.1.1 By Function

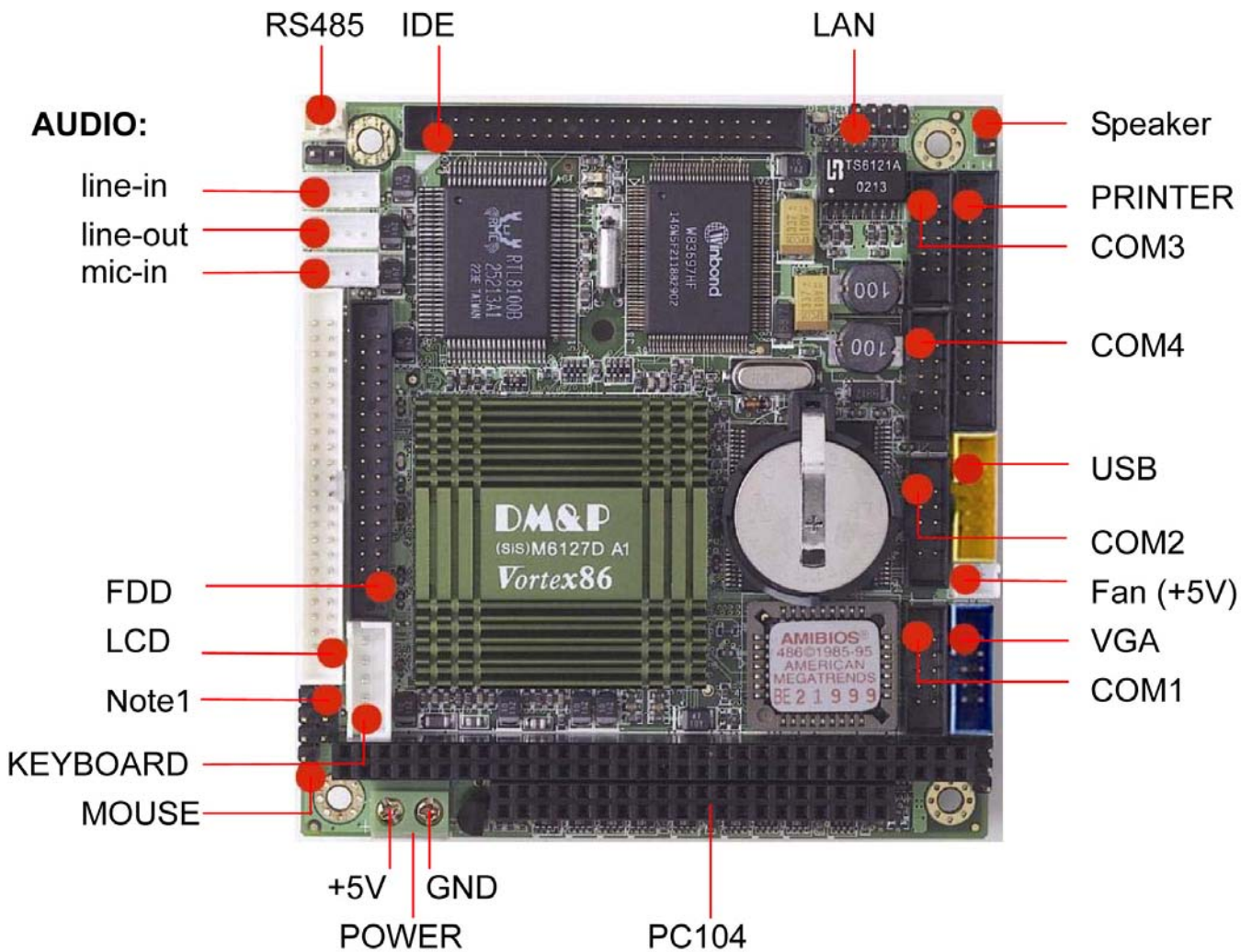

Note1: LCD Voltage Select

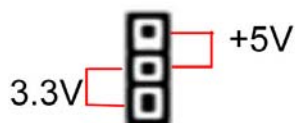

2.1.1 By Location

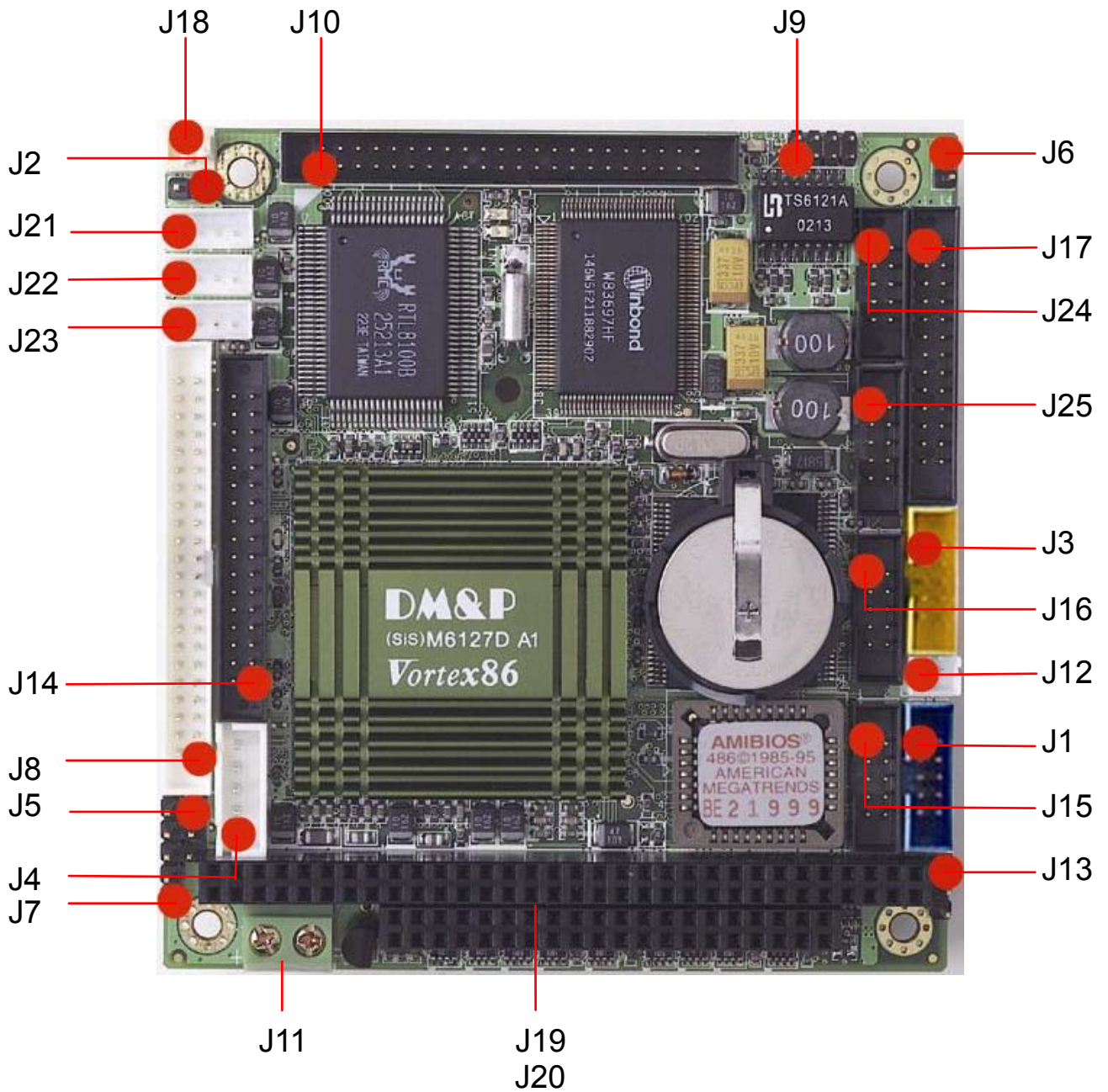

● The red dot indicates the first pin of each connector

Chapter 2

Installation

2.1 Board Outline

2.1.1 By Function

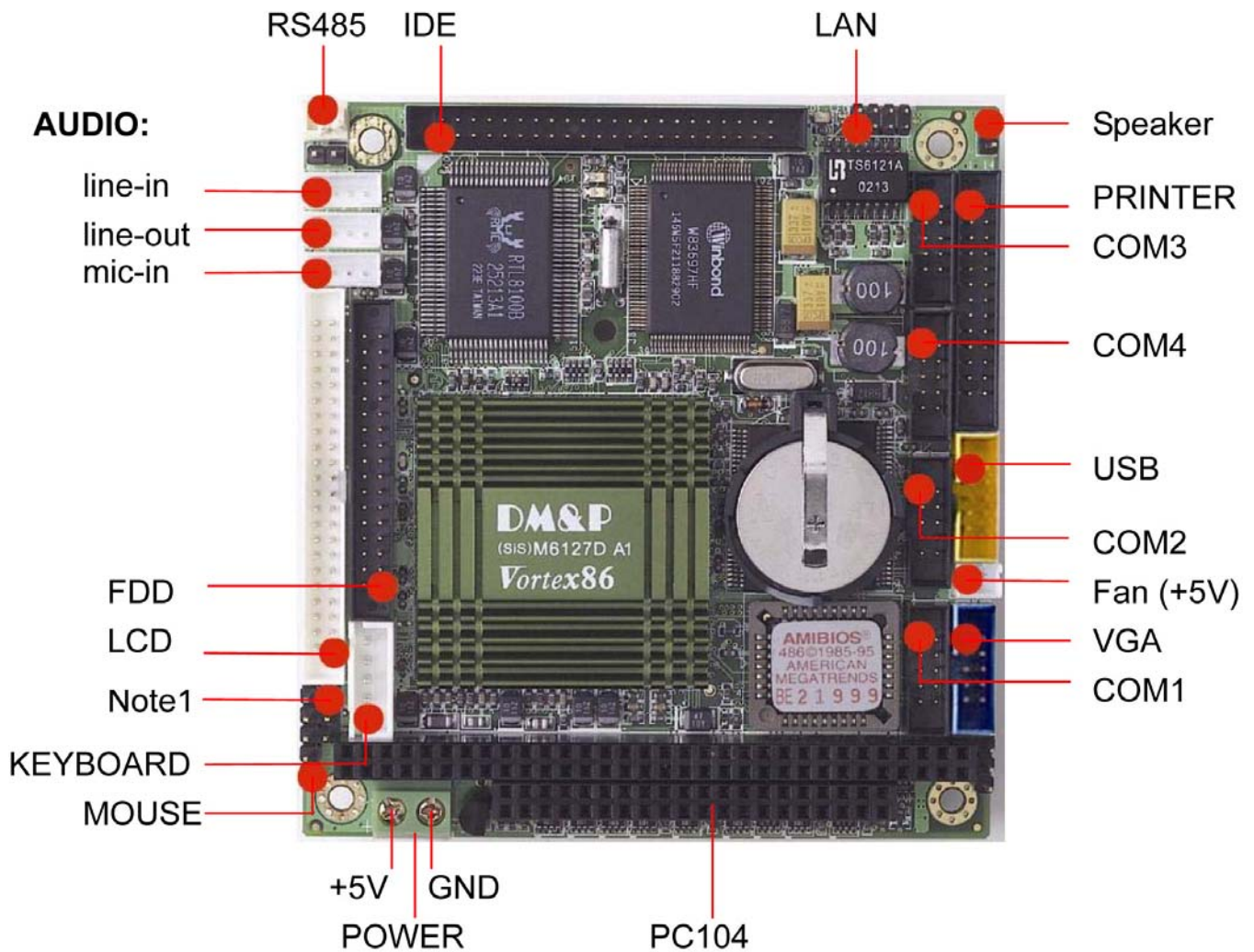

Note1: LCD Voltage Select

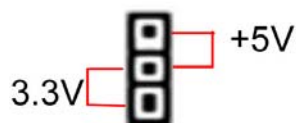

2.3 Pin Assignments & Jumper Settings

J1 : VGA Connector - 2.0 Ø 10-pin Box Header

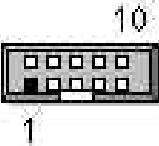
	Pin #	Signal Name	Pin #	Signal Name
	1	ROUT	2	GND
	3	GOUT	4	GND
	5	BOUT	6	GND
	7	HSYNC	8	GND
	9	VSYNC	10	GND



J2 : RESET - 2-pin Header

	Pin #	Signal Name
	1	PWROK
	2	GND

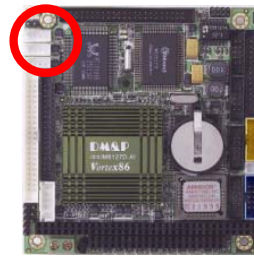

J3 : USB Connector - 2.0 Ø pitch 10-pin Box Header

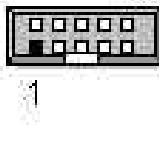
	Pin #	Signal Name	Pin #	Signal Name
	1	VCC	2	VCC
	3	-DATA1	4	-DATA0
	5	+DATA1	6	+DATA0
	7	GND	8	GND
	9	GND	10	GND

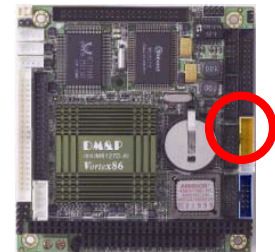

J4 : PS/2 Keyboard Connection - 5-pin Molex Header

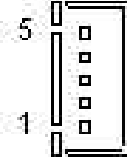
	Pin #	Signal Name
	1	KBCLK
	2	KBDAT
	3	NC
	4	GND
	5	SB 5V (VCC)

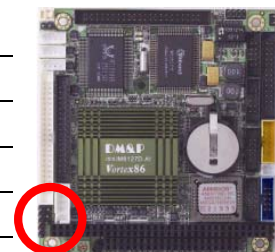

J6 : Speaker - 2-pin Header

	Pin #	Signal Name
	1	SPKR
	2	VCC

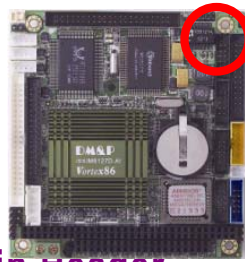

J7 : PS/2 Mouse Connection- 5-pin header

	Pin #	Signal Name
	1	PMCLK
	2	PMDAT
	3	NC
	4	GND
	5	SB 5V (VCC)

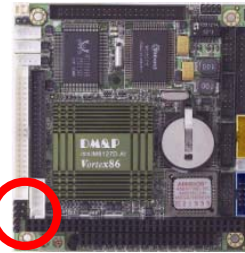

J8 : LCD Connector - 2.0 Ø pitch 44-pin Box Header

Pin #	Signal Name	Pin #	Signal Name	SISSED	DSTN	DIGITAL	RGB
				CONN.		18-BIT	24-BIT
1	LCDVCC	2	LCDVCC	VAD0	LD0	G2	G4
3	VAD0	4	VAD1	VAD1	LD1	G3	G5
5	VAD2	6	VAD3	VAD2	LD2	G4	G6
7	VAD4	8	VAD5	VAD3	LD3	G5	G7
9	VAD6	10	VAD7	VAD4	LD4		R0
11	VAD8	12	VAD9	VAD5	LD5		R1
13	VAD10	14	VAD11	VAD6	LD6	R0	R2
15	GND	16	UD4	VAD7	LD7	R1	R3
17	UD5	18	UD6	VAD8	UD0	R2	R4
19	UD7	20	GND	VAD9	UD1	R3	R5
21	VBD0	22	VBD1	VAD10	UD2	R4	R6
23	VBD2	24	VBD3	VAD11	UD3	R5	R7
25	VBD4	26	VBD5				
27	VBD6	28	VBD7	VBD0			B0
29	VBD8	30	VBD9	VBD1			B1
31	VBD10	32	VBD11	VBD2		B0	B2
33	GND	34	GND	VBD3		B1	B3
35	PLDXCLK	36	VBGCLK	VBD4		B2	B4
37	VADE	38	VBDE	VBD5		B3	B5
39	AHSYNC	40	VBHSYNC	VBD6		B4	B6
41	AVSYNC	42	VBVSYNC	VBD7		B5	B7
43	DISPOFF	44	VDDEN	VBD8			G0
				VBD9			G1
				VBD10		G0	G2
				VBD11		G1	G3

J5: LCD Volts Selection - 3-pin Header

Pin #	Signal Name
1-2	+5V
2-3	+3.3V

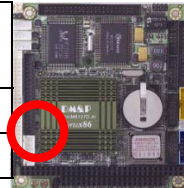

UD4	UD4		
UD5	UD5		
UD6	UD6		
UD7	UD7		
PLDXCLK	SHFCLK		
VADE	MOD/LDE		
VAHSYNC	LP/HYSNC		
VHVSNC	FLM/VYSNC		
DISOFF	ENBT		
VBGCLK		XCLK	XCLK
VBDE		DEN	DEN
VBHSYNC		HSYNC	HSYNC
VBVSYNC		VSNC	VSNC
VDDEN	VDDEN	VDDEN	VDDEN

J9 : LAN Connection - 8-pin Header

	Pin #	Signal Name	Pin #	Signal Name
	1	TX+	2	TX-
	3	RX+	4	LED0
	5	LED0+	6	RX-
	7	LED1+	8	LED1

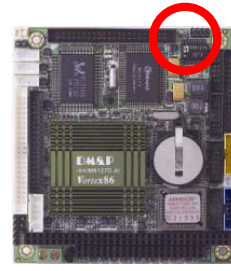

J10 : IDE Connector - 2.0 Ø pitch 44-pin Box Header

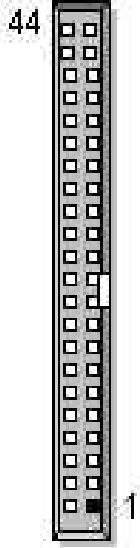
	Pin #	Signal Name	Pin #	Signal Name
	1	IDERST-	2	GND
	3	IDED7	4	IDED8
	5	IDED6	6	IDED9
	7	IDED5	8	IDED10
	9	IDED4	10	IDED11
	11	IDED3	12	IDED12
	13	IDED2	14	IDED13
	15	IDED1	16	IDED14
	17	IDED0	18	IDED15
	19	GND	20	NC
	21	IDEREQ	22	GND
	23	IDEIOW-	24	GND
	25	IDEIOR-	26	GND
	27	ICHRDY	28	GND
	29	IDACK-	30	GND
	31	IDEIRQ	32	NC
	33	IDESA1	34	CBLID
	35	IDESA0	36	IDESA2
	37	IDECS-0	38	IDECS-1
39	DASP	40	GND	
41	VCC	42	VCC	
43	GND	44	NC	

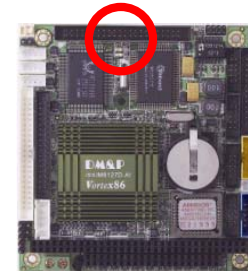

J11 : Power Connector - 2-pin Header

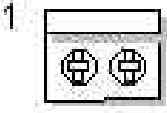
	Pin #	Signal Name
	1	SB5V
	2	GND

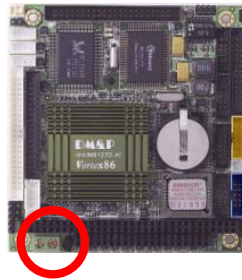

J12 : CPU FAN - 2-pin Molex Header

	Pin #	Signal Name
	1	VCC
	2	GND

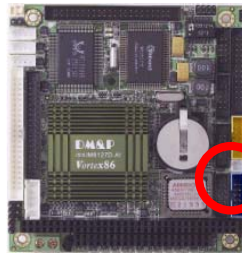

J13 : RS232/RS485 Select - 3-pin Header

	Pin #	Signal Name
	1-2	COM2 RS232
	2-3	RS485

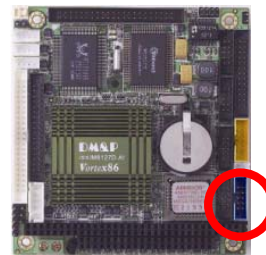

J14 : FDD Connector - 2.0 Ø 34-pin Box Header (17x2)

Pin #	Signal Name	Pin #	Signal Name
1	GND	2	DENSEL
3	GND	4	NC
5	GND	6	NC
7	GND	8	INDEX\
9	GND	10	MTRO\
11	GND	12	DS1\
13	GND	14	DS0\
15	GND	16	MTR1\
17	GND	18	DIR\
19	GND	20	STEP\
21	GND	22	WD\
23	GND	24	WG\
25	GND	26	TR0\
27	GND	28	WP\
29	GND	30	RD\
31	GND	32	HDSEL\
33	GND	34	DSKCHG\

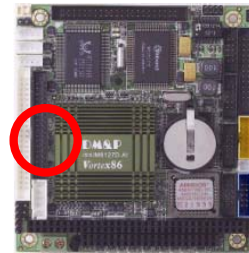
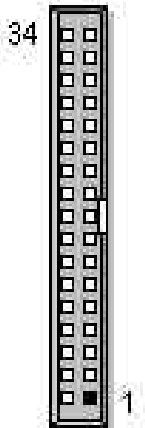

J15 : COM1 Connection (RS-232 Connector) - 2.0 Ø 10-pin Box Header

Pin #	Signal Name	Pin #	Signal Name
1	DCD1	2	RXD1
3	TXD1	4	DTR1
5	GND	6	DSR1
7	RTS1	8	CTS1
9	RI1	10	NC

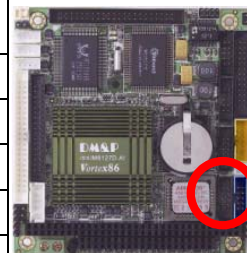
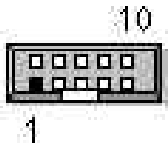

J16 : COM2 Connection (RS-232 Connector) - 2.0 Ø 10-pin Box Header

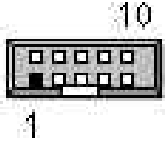
	Pin #	Signal Name	Pin #	Signal Name
	1	DCD2	2	RXD2
	3	TXD2	4	DTR2
	5	GND	6	DSR2
	7	RTS2	8	CTS2
	9	RI2	10	NC

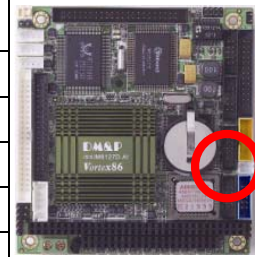

J17 : Printer Connector - 2.0 Ø 26-pin Box Header

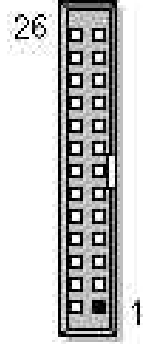
	Pin #	Signal Name	Pin #	Signal Name
	1	STB-	14	AFD-
	2	PD0	15	ERR-
	3	PD1	16	PRINIT-
	4	PD2	17	SLIN-
	5	PD3	18	GND
	6	PD4	19	GND
	7	PD5	20	GND
	8	PD6	21	GND
	9	PD7	22	GND
	10	ACK-	23	GND
	11	BUSY	24	GND
	12	PE	25	GND
	13	SLCT	26	NC



J18 : RS485 Connection- 2.54 Ø 2-pin Molex Header

	Pin #	Signal Name
	1	RS485+
	2	RS485-

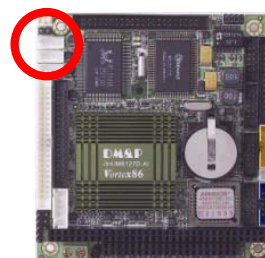

J19 : PC/104 Connector - 64-pin Header Connector (CN1)

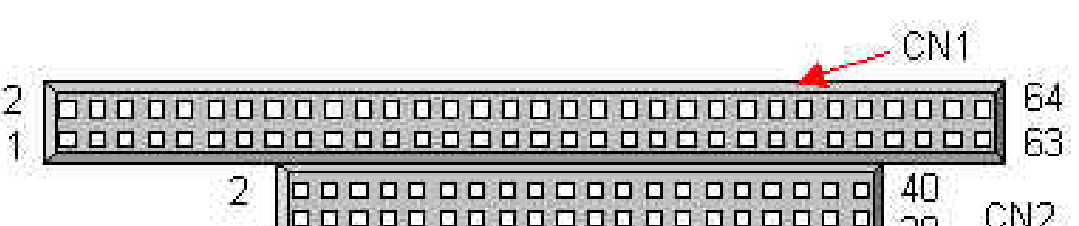

1	IOCHK *	2	GND
3	SD7	4	RSTDRV
5	SD6	6	VCC
7	SD5	8	IRQ9
9	SD4	10	-5V
11	SD3	12	DRQ2
13	SD2	14	-12V
15	SD1	16	OWS
17	SD0	18	+12V
19	IOCHRDY	20	GND
21	AEN	22	SMEMW *
23	SA19	24	SMEMR *
25	SA18	26	IOW *
27	SA17	28	IOR *
29	SA16	30	DACK3 *
31	SA15	32	DRQ3
33	SA14	34	DACK1 *
35	SA13	36	DRQ1
37	SA12	38	REFRESH *
39	SA11	40	SYSCLK
41	SA10	42	IRQ7
43	SA9	44	IRQ6
45	SA8	46	IRQ5
47	SA7	48	IRQ4
49	SA6	50	IRQ3
51	SA5	52	DACK2 *
53	SA4	54	TC
55	SA3	56	BALE
57	SA2	58	VCC
59	SA1	60	OSC
61	SA0	62	GND
63	GND	64	GND

J20 : PC/104 Connector - 40pin Header Connector (CN2)

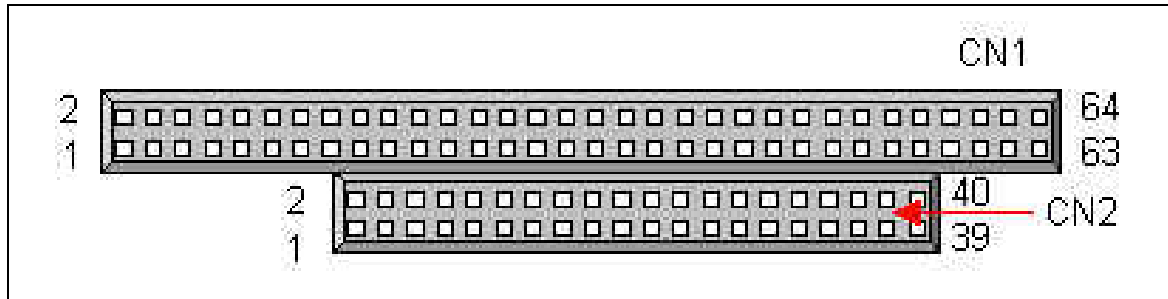

1	GND	2	GND
3	MEMCS16 *	4	SBHE *
5	IOCS16 *	6	LA23
7	IRQ10	8	LA22
9	IRQ11	10	LA21
11	IRQ12	12	LA20
13	IRQ15	14	LA19
15	IRQ14	16	LA18
17	DACK0 *	18	LA17
19	DRQ0	20	MEMR *
21	DACK5 *	22	MEMW *
23	DRQ5	24	SD8
25	DACK6 *	26	SD9
27	DRQ6	28	SD10
29	DACK7 *	30	SD11
31	DRQ7	32	SD12
33	VCC	34	SD13
35	MASTER *	36	SD14
37	GND	38	SD15
39	GND	40	NC

J21 : Line-in Connector - 2.0 Ø 4-pin Box Header Connector

	Pin #	Signal Name
	1	LINEIN_R
	2	GND
	3	GND
	4	LINEIN_L

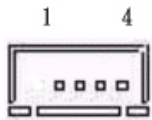

J22 : Line-out Connector - 2.0 Ø 4-pin Box Header Connector

	Pin #	Signal Name
	1	LOUTR
	2	GND
	3	GND
	4	LOUTL

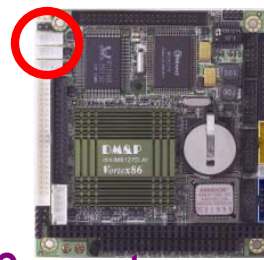

J23 : Mic-in Connector - 2.0 Ø 4-pin Box Header Connector

	Pin #	Signal Name
	1	VREFOUT
	2	GND
	3	GND
	4	MIC1

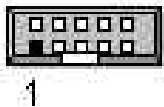

J24 : COM3 Connection (RS-232 Connector) - 2.0 Ø 10-pin Box Header

	Pin #	Signal Name	Pin #	Signal Name
	1	DCD3	2	RXD3
	3	TXD3	4	DTR3
	5	GND	6	DSR3
	7	RTS3	8	CTS3
	9	RI3	10	NC

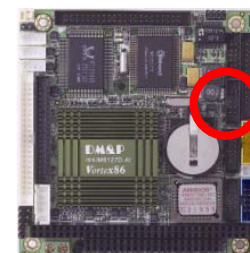

J25 : COM4 Connection (RS-232 Connector) - 2.0 Ø 10-pin Box Header

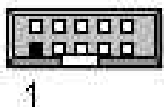
	Pin #	Signal Name	Pin #	Signal Name
	1	DCD4	2	RXD4
	3	TXD4	4	DTR4
	5	GND	6	DSR4
	7	RTS4	8	CTS4
	9	RI4	10	NC

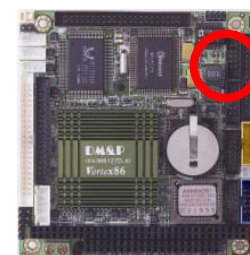

2.4 Watchdog Timer

The watchdog timer work flow of Vortex86 is: If the watchdog timer expires the first time, the expired event will set SFTMR0_STS and timer will reload its initial value and count again. If the timer expire the second time, the expired event will set SFTMR1_STS.

Software Watchdog Timer Initial Value: Default Value: FFh

I/O Address	Bit	Access	Description
84Ah	7:0	R/W	Software Watchdog Timer Initial Value Writing to this register will reload the software watchdog timer with the value specified in this register. If the software watchdog timer expires the first time, the expired event will set the SFTMR0_STS and the timer will reload its initial value and count again. If the timer expire the second time, the expired event will set the SFTMR1_STS. The timer value can't be read from this field.

Software Watchdog Timer Control Register: Default Value: 00h

I/O Address	Bit	Access	Description
84Bh	7	R/W	Software Watchdog Timer Counting Enable The software watchdog timer will start to count when this bit is set to one.
	6	RO	Reserved
	5:4	R/W	Software Watchdog Timer Clock Select 00 : 4 ms 01 : 1 second 10 : 1 minute 11 : 1 hour

3:2	R/W	Software Watchdog Timer Expiration Event 1 Routing Select When SFTMR1_STS is set to one, an SMI#/SFTIRQ/PCIRST# will be generated according to the following combination. 00 : No effect 01 : SMI# 10 : SFTIRQ 11 : PCIRST#
1:0	R/W	Software Watchdog Timer Expiration Event 0 Routing Select When SFTMR0_STS is set to one, an SMI#/SFTIRQ/PCIRST# will be generated according to the following combination. 00 : No effect 01 : SMI# 10 : SFTIRQ 11 : PCIRST#

Legacy Event Status Register: Default Value: 00h

I/O	Bit	Access	Description
Address			
841h	7	R/WC	Software Watch Dog Timer Event 1 Status (SFTMR1_STS) This bit is set when the software watchdog timer expires the second time. This status bit does not have its corresponding enable bit and can survive under PCIRST#.
	6	R/WC	Software Watch Dog Timer Event 0 Status (SFTMR0_STS) This bit is set when the software watchdog timer expires the second time. This status bit does not have its corresponding enable bit and can survive under PCIRST#.

C Example

Those C code for DOS will show you more: ([Download C source code for DOS and execute file](#))

```
#include <conio.h>
#include <stdio.h>
#include <time.h>

void main()
{
    clock_t clk;
    int      nTime = 5;

    /* set time out */
    outp(0x84a, nTime);

    /* set timer clock to 1 second and "Timer Expiration Event 0/1" to reset system.
    */
    outp(0x84b, 0x9c);

    printf("Press any key to stop clearing watchdog timer status...\n");
    while(!kbhit())
    {
        /* clear "Timer Expiration Event 0/1" bit */
        outp(0x841, 0xc0);
    }

    getch();

    printf("System will be reset after %d seconds.\n", nTime * 4);

    clk = clock();
    while(!kbhit())
        printf("%02.2f\r", (clock() - clk) / CLK_TCK);
}
```

Assembler Example code

```
mov dx,84ah ; set timeout = 20 second
mov al,5
out dx,al
mov dx,84bh ; set timer clock to 1 second and "Timer Expiration Event 0/1" to
reset system.
mov al,9ch
out dx,al

; clearing watchdog timer status
mov dx,841h
mov al,0c0h
out dx,al
```

Chapter 3

SVGA Setup

3.1 Introduction

The VTX-6071 offers high performance/low cost *Vortex™* SoC (System on Chip) solution that integrates a x86 compatible processor, high performance North Bridge, advanced hardware GUI engine and Super-South bridge into a single chipset – this SoC design supports the now PC technology, USB, Legacy Removal, CIR, Memory Stick, Smart Card and Slotless Design for a variety of Industrial Applications covering automation, data acquisition, internet communication, and other information exchange devices. It also has a built-in VGA controller.

3.1.1 SoC Chipset

The embedded video uses the integrated Ultra-AGP™ VGA controller for Hardware 2D/video/Graphics Accelerators, this board supports conventional analog CRT monitor or flat panel. It is both AGP 4X / Fully DirectX 8 Compliant. It also provides Monitor / Secondary CRT Monitor output. This video SVGA controller supports conventional analog CRT monitor or flat panel. In addition, it also supports interlaced and non-interlaced analog monitors (color and monochrome VGA) in high-resolution modes while maintaining complete IBM VGA compatibility. Multiple frequency (multi-sync) monitors are handled as if they were analog monitors.

3.1.2 Display memory

The VGA controller can drive CRT displays or color panel displays with resolutions up to 1920 x 1440 at 256 colors (True colors). It supports Shared System Memory up to 128 MB.

3.2 Flat Panel BIOS Wiring

The VTX-6071 offers high performance/low cost *Vortex™* SoC (System on Chip) solution that integrates a x86 compatible processor, high performance North Bridge, advanced hardware GUI engine and Super-South bridge into a single chipset – this SoC design supports the now PC technology, USB, Legacy Removal, CIR, Memory Stick, Smart Card and Slotless Design for a variety of Information Exchange applications. It also has a built-in VGA controller. Shown on next page are the -

Supported Flat Panels:

- - PVI 6.4" TFT LCD panel P/N: V16C6448AC
- SHARP 6.4" TFT LCD panel P/N: LQ64D341 (HIROSE DF9BA-31P-1V)
- NEC 6.5" TFT Color LCD panel P/N: NL6448BC20-08 (HIROSE DF9B-31P-1V)
- AU 8.4" LVDS Color LCD panel P/N: B084SN01
- AU 10.4" LVDS Color LCD panel P/N: B104SN01
- AU 13.3" LVDS Color LCD panel P/N: UB133X01

- PVI 6.4" TFT LCD panel P/N: V16C6448AC

TFT-LCD Panel Driving

Pin No.	Symbol	Function	Remark
1	GND	Ground (0V)	
2	CLK	Clock Signal for Sampling Image Digital Data	
3	Hsync	Horizontal Synchronous Signal	Note 5-1
4	Vsync	Vertical Synchronous Signal	Note 5-1
5	GND	Ground (0V)	
6	R0	Red Image Data Signal (LSB)	
7	R1	Red Image Data Signal	
8	R2	Red Image Data Signal	
9	R3	Red Image Data Signal	
10	R4	Red Image Data Signal	
11	R5	Red Image Data Signal (MSB)	
12	GND	Ground (0V)	
13	G0	Green Image Data Signal (LSB)	
14	G1	Green Image Data Signal	
15	G2	Green Image Data Signal	
16	G3	Green Image Data Signal	
17	G4	Green Image Data Signal	
18	G5	Green Image Data Signal (MSB)	
19	GND	Ground (0V)	
20	B0	Blue Image Data Signal (LSB)	
21	B1	Blue Image Data Signal	
22	B2	Blue Image Data Signal	
23	B3	Blue Image Data Signal	
24	B4	Blue Image Data Signal	
25	B5	Blue Image Data Signal (MSB)	
26	GND	Ground (0V)	
27	DENB	Disable	
28	VCC	DC +5.0V Power Supply	
29	VCC	DC +5.0V Power Supply	
30	R/L	Horizontal Image Shift-direction Select Signal	Note 5-2
31	U/D	Vertical Image Shift-direction Select Signal	Note 5-3

Note: The TFT-LCD panel display is compatible with four kinds of timing. They are VGA-480, VGA-400, VGA-350 and freedom mode. The polarization of Hsync and Vsync determine the timings.

	VGA-480	VGA-400	VGA-350	Freedom Mode
Hsync Polarization	Negative	Negative	Positive	Positive
Vsync Polarization	Negative	Positive	Negative	Positive

- SHARP 6.4" TFT LCD panel P/N: LQ64D341 (HIROSE DF9BA-31P-1V)

TFT-LCD panel driving

CNI Used connector: DF9BA-31P-1V (Hirose Electric Co., Ltd.)

1					31	Corresponding connector: DF9 -31S-1V (//)
2					30	DF9A-31S-1V (//)
CNI pin arrangement from module surface (Transparent view)						DF9B-31S-1V (//)
						DF9M-31S-1V (//)

Pin No.	Symbol	Function	Remark
1	GND	—	—
2	CK	Clock signal for sampling each data signal	—
3	Hsync	Horizontal synchronous signal	【Note1】
4	Vsync	Vertical synchronous signal	【Note1】
5	GND	—	—
6	R0	R E D data signal(LSB)	—
7	R1	R E D data signal	—
8	R2	R E D data signal	—
9	R3	R E D data signal	—
10	R4	R E D data signal	—
11	R5	R E D data signal(MSB)	—
12	GND	—	—
13	G0	G R E E N data signal(LSB)	—
14	G1	G R E E N data signal	—
15	G2	G R E E N data signal	—
16	G3	G R E E N data signal	—
17	G4	G R E E N data signal	—
18	G5	G R E E N data signal(MSB)	—
19	GND	—	—
20	B0	B L U E data signal(LSB)	—
21	B1	B L U E data signal	—
22	B2	B L U E data signal	—
23	B3	B L U E data signal	—
24	B4	B L U E data signal	—
25	B5	B L U E data signal(MSB)	—
26	GND	—	—
27	ENAB	Signal to settle the horizontal display position	【Note2】
28	Vcc	+ 3.0V power supply	—
29	Vcc	+ 3.0V power supply	—
30	R/L	Horizontal display mode select signal	【Note3】
31	U/D	Vertical display mode select signal	【Note4】

- NEC 6.5" TFT Color LCD panel P/N: NL6448BC20-08 (HIROSE DF9B-31P-1V)

CN31 socket (LCD module side): DF9B-31P-1V (Hirose Electric Co., Ltd.)

Adaptable plug: DF9-31S-1V (Hirose Electric Co., Ltd.)

Pin No.	Symbol	Signal	Remarks
1	GND	Ground	
2	CLK	Dot clock	
3	Hsync	Horizontal synchronous	
4	Vsync	Vertical synchronous	
5	GND	Ground	
6	R0	Red data (LSB)	Least significant bit
7	R1	Red data	
8	R2	Red data	
9	R3	Red data	
10	R4	Red data	
11	R5	Red data (MSB)	Most significant bit
12	GND	Ground	-
13	G0	Green data (LSB)	Least significant bit
14	G1	Green data	
15	G2	Green data	
16	G3	Green data	
17	G4	Green data	
18	G5	Green data (MSB)	Most significant bit
19	GND	Ground	-
20	B0	Blue data (LSB)	Least significant bit
21	B1	Blue data	
22	B2	Blue data	
23	B3	Blue data	
24	B4	Blue data	
25	B5	Blue data (MSB)	Most significant bit
26	GND	Ground	-
27	DE	Select of DE / Fixed mode	DE mode: Data enable signal, Fixed mode: Open
28	VCC	Power supply	
29	VCC	Power supply	
30	NC	Non connection	
31	DPSR	Select of scan direction	Normal scan: Low or Open, Reverse scan: High Note1.

Note1: See "4.8 SCANNING DIRECTIONS".

CN31: Figure of socket

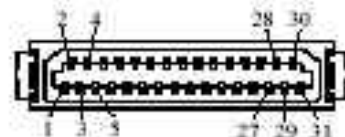

Chapter 4

Network Interface

4.1 Introduction

The Realtek RTL-8100B 10/100Mbps Ethernet controller board supports both 10/100BASE-T and Coax 10Base-2 'BNC' connectors, and allows direct connection to your 10/100Mbps Ethernet based Local Area Network for full interaction with local servers, wide area networks such as the Internet.

I/O and IRQ settings can be done by software with the supplied utility software, or it can be set for Plug and Play compatibility. The controller supports : Full-Duplex Ethernet function to double channel bandwidth, auto media detection.

4.2 Software Support

On-board EEPROM (93C46) programming

- Setup/Diagnostic program for DOS
- Help utility for easy installation
- RPL boot ROM for Novell Netware, Microsoft NT
- NDIS2 (DOS, OS/2, Lantastic, WFW3.1;K;K)
- NDIS3, NDIS4, NDIS5 for WIN95, 98, NT3.51, 4.0, 5.0, WFW3.11
- Netware 16-bit ODI driver for DOS, OS/2 and 32-bit ODI driver for Netware 3.x, 4.x, 5.0 Server
- Packet driver for UNIX Client
- SCO Unix driver
- Linux driver

● All operating systems that support standard NE2000

Warranty

This product is warranted to be in good working order for a period of one year from the date of purchase. Should this product fail to be in good working order at any time during this period, we will, at our option, replace or repair it at no additional charge except as set forth in the following terms. This warranty does not apply to products damaged by misuse, modifications, accident or disaster. Vendor assumes no liability for any damages, lost profits, lost savings or any other incidental or consequential damage resulting from the use, misuse of, originality to use this product. Vendor will not be liable for any claim made by any other related party. Return authorization must be obtained from the vendor before returned merchandise will be accepted. Authorization can be obtained by calling or faxing the vendor and requesting a Return Merchandise Authorization (RMA) number. Returned goods should always be accompanied by a clear problem description.