

Our Products Make Your Product Better®

To learn more about EMAC's products and services and how they can help your project

http://ftp.emacinc.com/Tech_Info/About_EMAC_Products_and_Services.pdf



Authorized Distributor, Integrator, and Value-Added Reseller

Manual downloaded from ftp.emacinc.com

For purchase information please contact info@emacinc.com

For technical support please submit a ticket at www.emacinc.com/support

EmCORE- i313

*PC-104 386SX-40 Module with
Flat Panel / CRT SVGA, Digital
I/O and LAN*

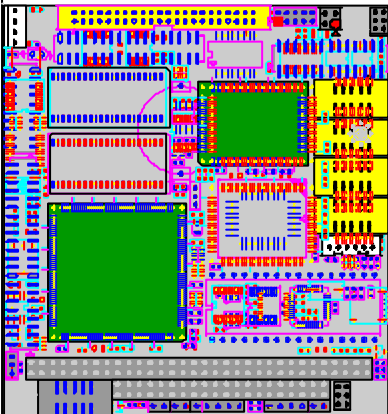

ALi M6117 compatible 386SX-40
CPU, 4MB EDO RAM Onboard,
Supports DOC 2000, EIDE Interfac-
es, Realtek 8019AS 10BASE-T

Table of Contents



INFO

Specifications	3
Ordering Codes	4

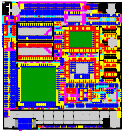

OVERVIEW

Board Image.....	5
Board Layout.....	6



HANDLING

Jumper/Connector Quick Reference	7
Jumper/Connector Quick Reference	8
DOC, Flash and EPROM	9
RS-232 & 485 selection On COM1 & COM2 10	
COM2 RS-232/485 selection (J4)	10
RS-232/485 Mode on COM1 and COM2	10
LCD Power Selection	11
Switches and Indicators	12
Power Connector	13
Fast Ethernet Connectors	14
Enhanced IDE Connector	15
Floppy Disk Drive Connector	16
Peripheral Port	17
PS/2 Keyboard & Mouse	18
16-bit General Purpose I/O	19
LCD Connector	20



WARRANTY

Warranty	21
----------------	----

Specifications

- **CPU + Chipset** : ALi M6117 is an implementation of an INTEL compatible 386SX-40 CPU, Real-time clock, a watchdog timer and ALi's M6117 chipset
- **BIOS** : Y2K compliant AMI system BIOS
- **DRAM Memory**: 4MB EDO DRAM onboard
- **Bus Interface** : PC/104
- **Enhanced IDE** : Supports one port and up to two drives Enhanced IDE devices of PIO mode 4 44-pin connector
- **Flash Disk** : Supports Flash, EPROM and DOC 2000
- **Expansion Slot** : PC/104 Slot
- **Keyboard and Mouse Connectors**:
External PS/2 KB/Mouse port (6-pin) box wafer
- **Watchdog Timer** : generates either a RESET, NMI or an IRQ when your application loses control over the system. Normally the watchdog can trigger a user specified interrupt. The watchdog is configurable from 30.5 μ s to 512 seconds (in 30.5 μ s segments)

High Speed Multi I/O

- **Chipset** : ALi M6117
- **Serial ports**: 2 high speed RS-232 ports, 2 high speed RS-232/485 ports (jumper selectable). Both with 16C550 UART and 16 byte FIFO. BIOS enabled/disabled. (COM3 and COM4 are optional.)
- **Bidirectional Parallel Port** : supports SPP, EPP and ECP mode. BIOS enabled/disabled

Flat Panel Display Controller

- **Chipset** : TP6508IQ (C&T 65545 optional)
- **Memory** : 1 MB onboard
- **System Bus** : 16-bit ISA bus
- **Panel Data Bus** : 24-bit
- **Display** : CRT and Flat Panel TTL-24 bit

LAN Controller

- **Chipset** : Realtek 8019AS single chip system
- **Transfer mode**: Full-duplex transfer mode

Environmental and Power

- **Power Requirements**:
single voltage +5 V @ 800 mA with 4 MB EDO installed
- **Board Dimensions** : 90 (L) x 96 (W) mm.
- **Board Weight** : 100 g
- **Extended Operating Temperature**: -20~+70°C

Warning

PC/104 Modules and their components contain very delicate Integrated Circuits (IC). To protect the PC/104 Module and its components against damage from static electricity, you should always follow the following precautions when handling it :

1. Disconnect your PC/104 Module from the power source whenever you want to handle the module
2. Use a grounded wrist strap when handling the module.
3. Hold the module by the edges and try not to touch the IC chips, leads or circuitry
4. Place the module on a grounded antistatic pad or on the bag that came with the PC/104 Module when handling it.

Ordering Codes

EmCORE-i313DVL/4S

PC/104 386SX-40 Module with 4MB EDO, Flat Panel/CRT SVGA, Fast Ethernet, DiskOnChip socket and 4 serial ports

EmCORE-i313DVL

PC/104 386SX-40 Module with 4MB EDO, Flat Panel/CRT SVGA, Fast Ethernet, DiskOnChip socket and 2 serial ports

EmCORE-i313DV

PC/104 386SX-40 Module with 4MB EDO, Flat Panel/CRT SVGA, 2 serial ports and DiskOnChip socket

EmCORE-i313D/4S

PC/104 386SX-40 Module with 4MB EDO, DiskOnChip socket and 4 serial ports

Board Image

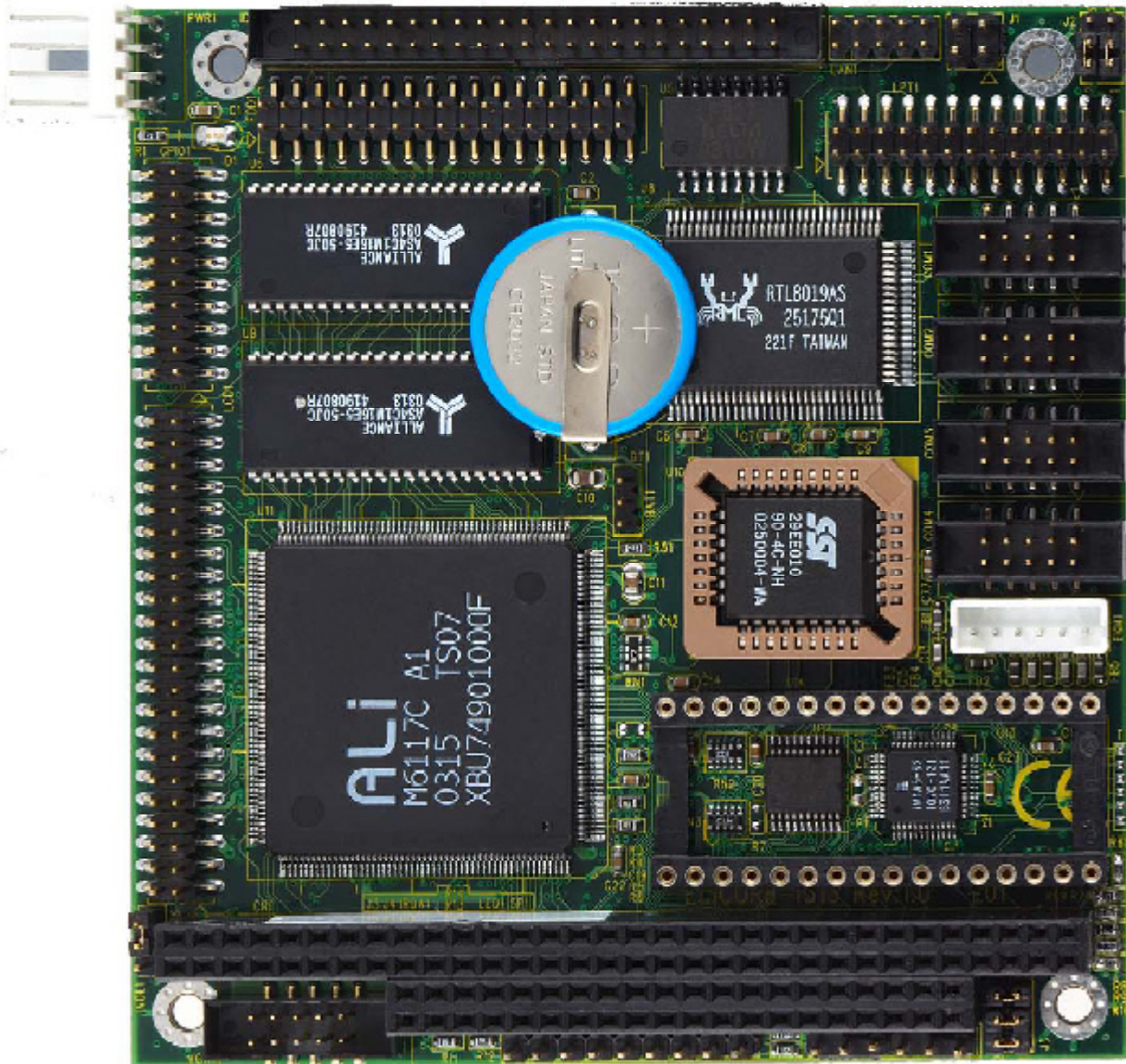

Board Layout

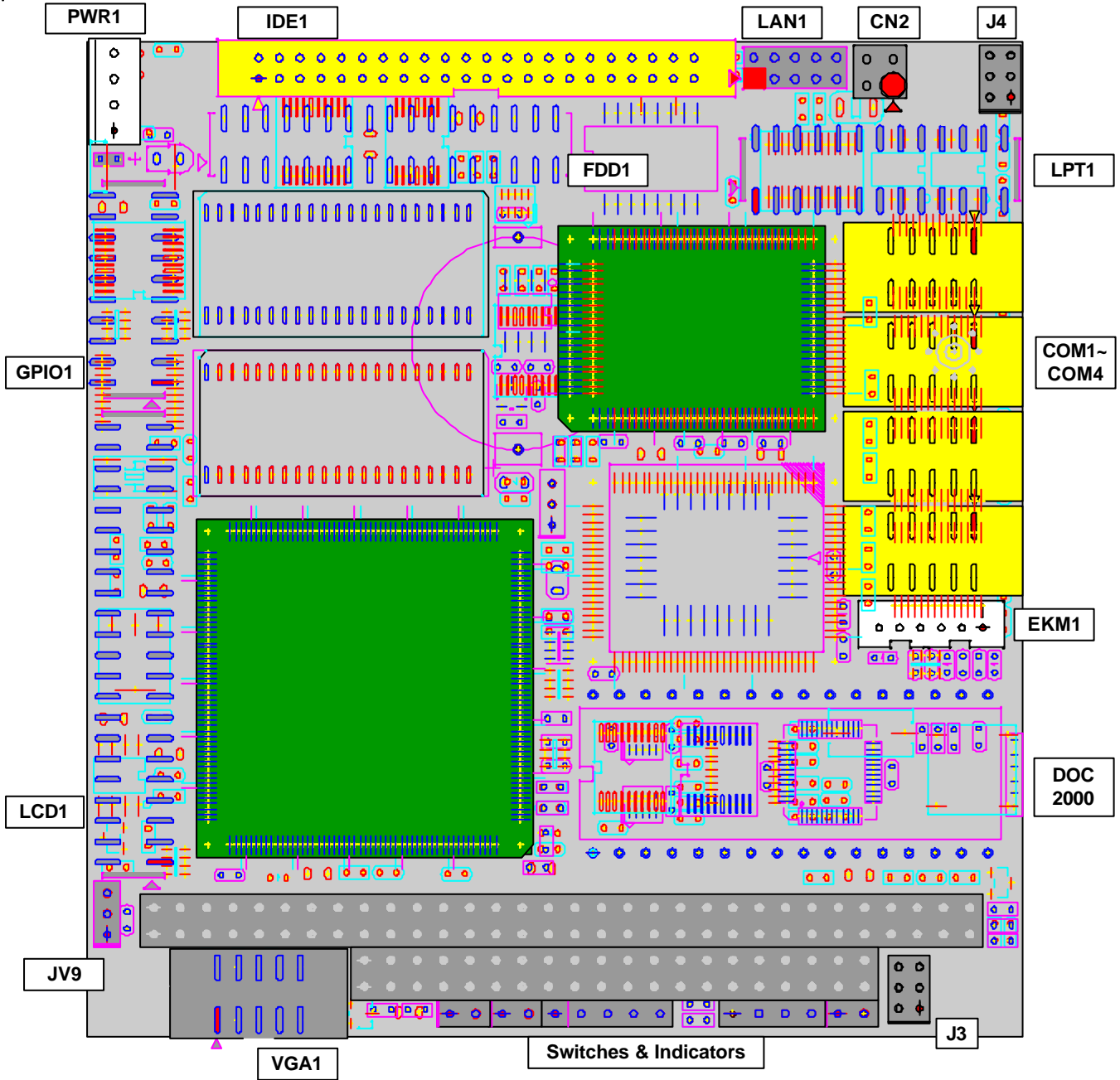

Jumper/Connector Quick Reference

Jumpers

Label	Function
J3	DOC, Flash and EPROM address selection
J4	RS-232 & RS-485 Selection on COM1 and COM2
JV9	LCD Power Selection

Jumper/Connector Quick Reference

Connectors

Label	Function
PWR1	Power 4P Power Connector
LAN1	LAN Connector
EKM1	PS/2 Keyboard and PS/2 Mouse
IDE1	Primary IDE Connector
LPT1	Parallel Port
LED1	LAN LED
HLED1	HDD LED
RES1	Reset
SP1	External Speaker
CN2	RS-485 Selection
GPIO1	16-bit General Purpose I/O
LCD1	LCD Connector

DOC, Flash and EPROM

Jumper : J3

Type : Onboard 6-pin header

Pin			Status
1-2	3-4	5-6	
ON	ON	ON	DOC, D0000
OFF	ON	ON	DOC, D8000
ON	OFF	ON	FLASH, D0000
OFF	OFF	ON	FLASH, D8000
OFF	ON	ON	FLASH, D4000
OFF	ON	OFF	EPROM, D0000
ON	OFF	OF	EPROM, D8000
OFF	OFF	OFF	All Open
default setting			DOC, D000

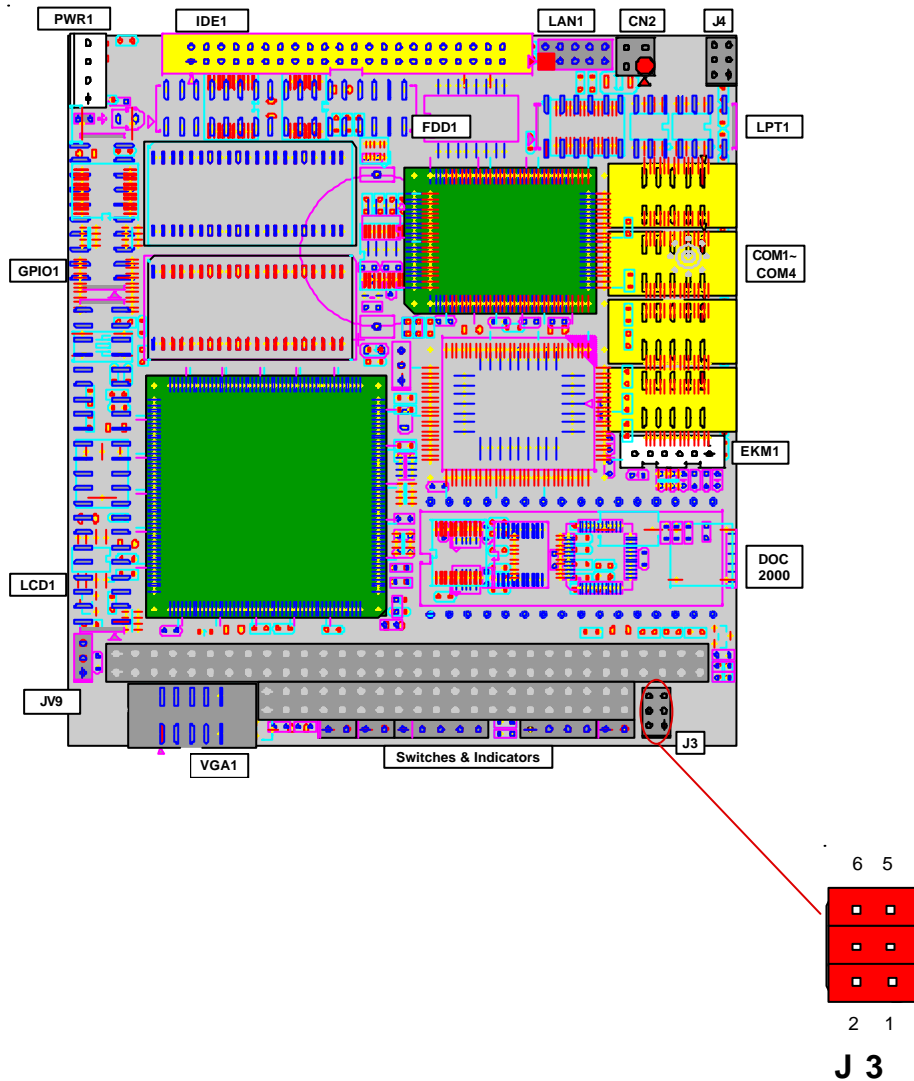

RS-232 & 485 selection On COM1 & COM2

COM2 RS-232/485 selection (J4)

The EMCORE-i313 offers two serial ports: COM1 and COM2. These ports let you connect to serial devices (mouse, printers, etc.), or to a communication network. The EMCORE-i313 serial ports can be configured by jumpers J4.

Jumper : J4

Type : onboard 6-pin(2*3) header

Pin Selection	Status
1-3	RS232 on COM1
2-4	RS232 on COM2
3-5	RS485 on CN2
4-6	RS485 on CN2

RS-232/485 Mode on COM1 and COM2

The onboard COM1 and COM2 port can be configured to operate in RS-232 or RS-485 modes. RS-232 modes differ in the way RX/TX is being handled. Jumper J4 switches between RS-232C or RS-485 mode. All of the RS-232C/485 modes are available on COM1 and COM2.

Pin	RS-232C	RS-485
1-3 :	COM1	x (Default)
3-5 :	x	CN2 1,2
2-4 :	COM2	x (Default)
4-6 :	x	CN2 3,4

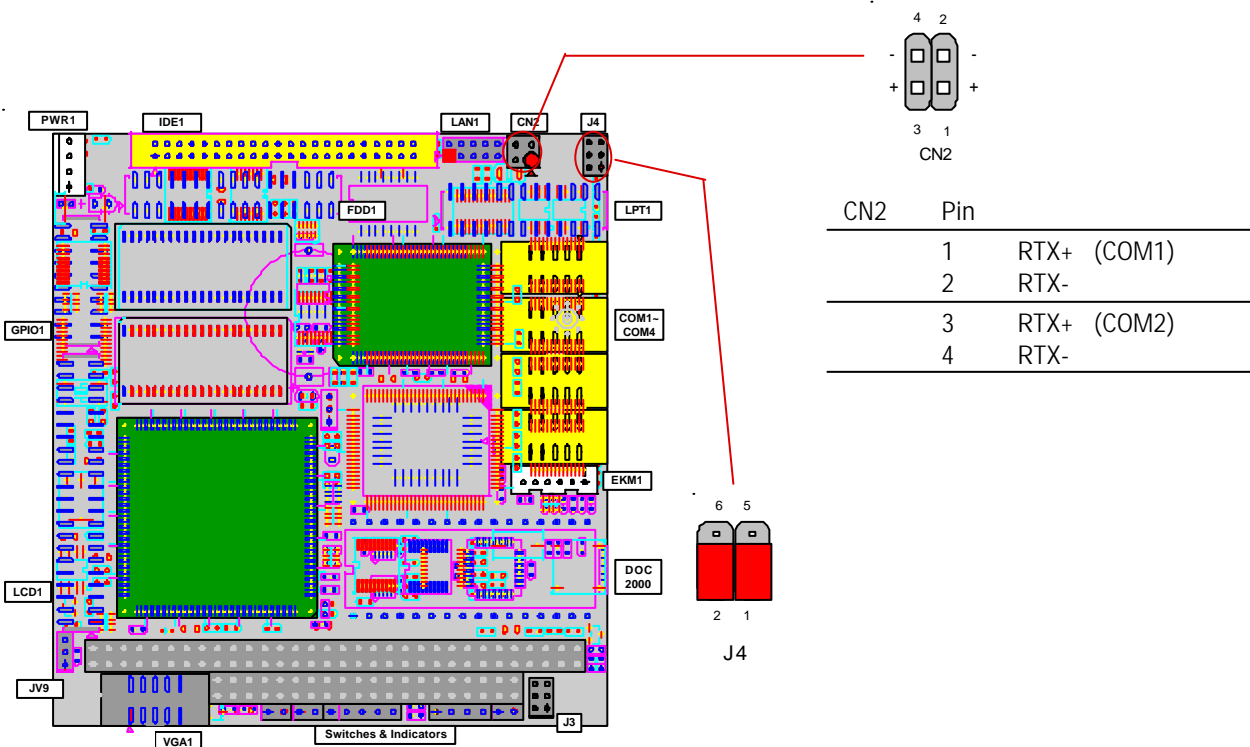

LCD Power Selection

Jumper : JV9

Type : onboard 3-pin header

The voltage of LCD panel could be selected by JV9 in 5V or 3.3V .

Mode	JV9
5V	1-2
3.3V	2-3
default setting +5V	

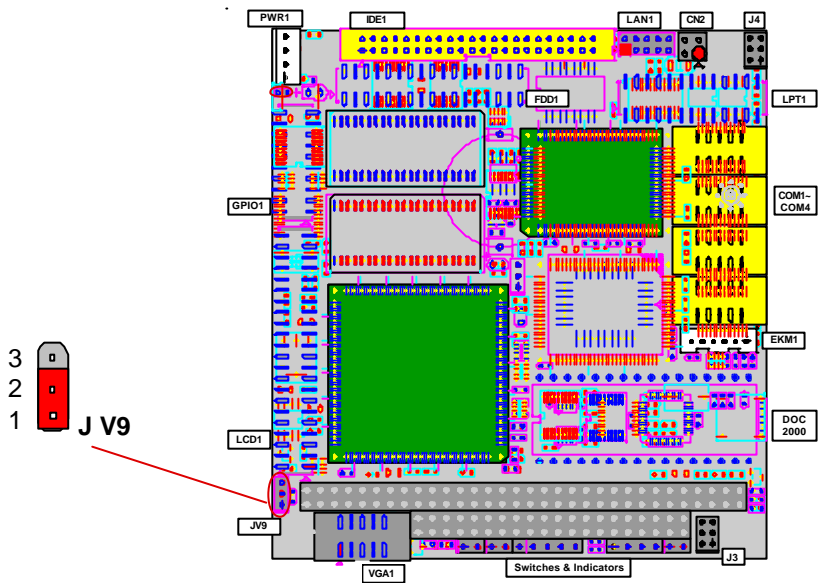

Switches and Indicators

Connector	Description
RES1	Reset function
HLED1	Hard Disk LED
LED1	LAN LED
SP1	Speaker

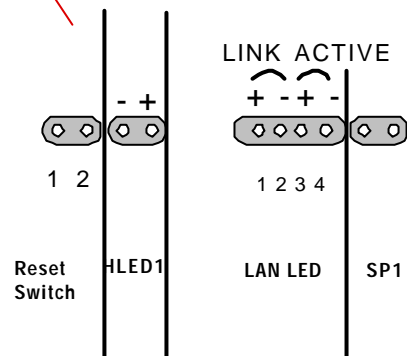
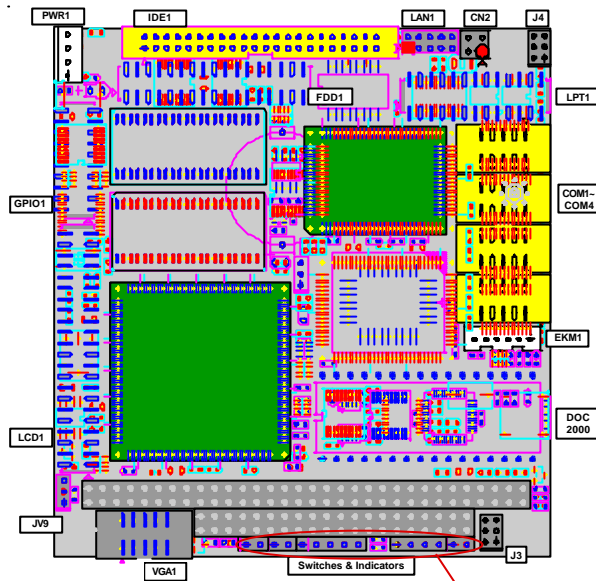

Power Connector

Power Connector : PWR1

Connector : **PWR1**

Type : PWR1: onboard small 4P connector

Pin	Description	Pin	Description
1	+5V	2	GND
3	GND	4	+12V

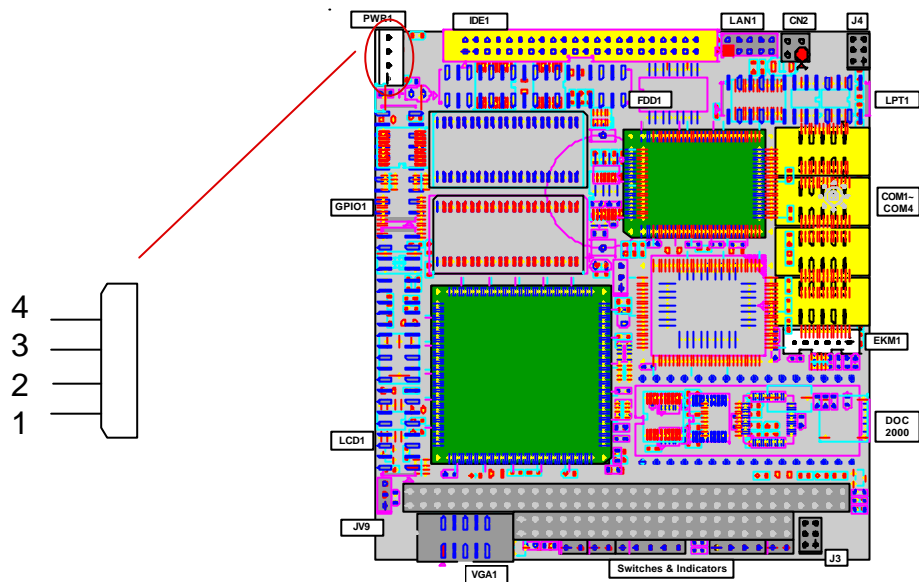

Fast Ethernet Connectors

Connector : **LAN1**
 Type : Onboard 10-pin header

Pin	Description	Pin	Description
1	TX+	2	TX-
3	RX+	4	NC
5	NC	6	RX-
7	NC	8	NC
9	GND	10	NC

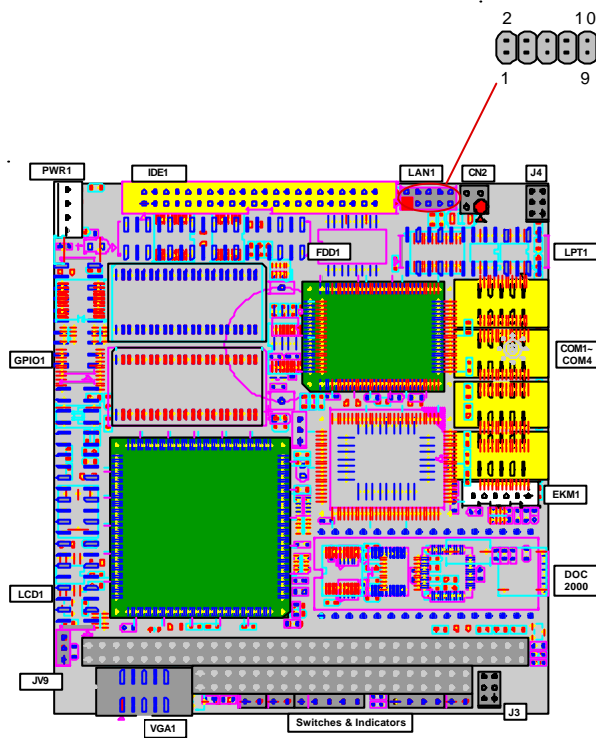

Enhanced IDE Connector

Connector : **IDE1**

Type : onboard 44-pin box headers

Pin	Description	Pin	Description
1	#RESET	2	GND
3	D7	4	D8
5	D6	6	D9
7	D5	8	D10
9	D4	10	D11
11	D3	12	D12
13	D2	14	D13
15	D1	16	D14
17	D0	18	D15
19	GND	20	NC/(Vcc)
21	REQ	22	GND
23	#IOW	24	GND
25	#IOR	26	GND
27	#IORDY	28	IDESEL
29	#DACK	30	GND
31	IRQ	32	NC
33	ADDR1	34	CBLID
35	ADDR0	36	ADDR2
37	#CS0	38	#CS1(#HD SELET1)
39	#ACT	40	GND
41	VCC	42	VCC
43	GND	44	NC

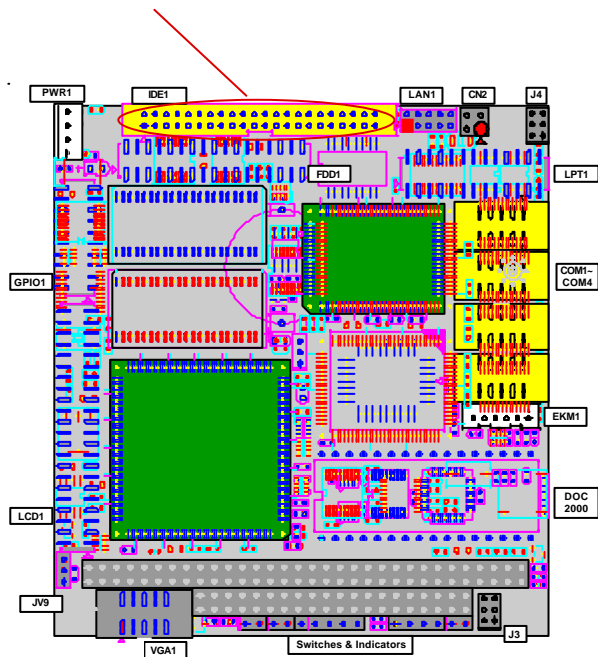
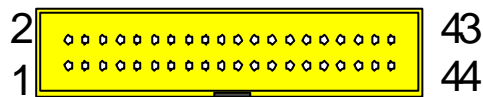

Floppy Disk Drive Connector

Connector : **FDD1**

Type : onboard 34-pin header

Pin	Description	Pin	Description
1	GND	2	DRIVE DENSITY SELECT 0
3	GND	4	DRIVE DENSITY SELECT 1
5	GND	6	NC
7	GND	8	#INDEX
9	GND	10	#MOTOR ENABLE A
11	GND	12	#DRIVER SELECT B
13	GND	14	#DRIVER SELECT A
15	GND	16	#MOTOR ENABLE B
17	GND	18	#DIRECTION
19	GND	20	#STEP
21	GND	22	#WRITE DATA
23	GND	24	#WRITE GATE
25	GND	26	#TRACK 0
27	GND	28	#WRITE PROTECT
29	GND	30	#READ DATA
31	GND	32	#HEAD SELECT
33	GND	34	#DISK CHANGE

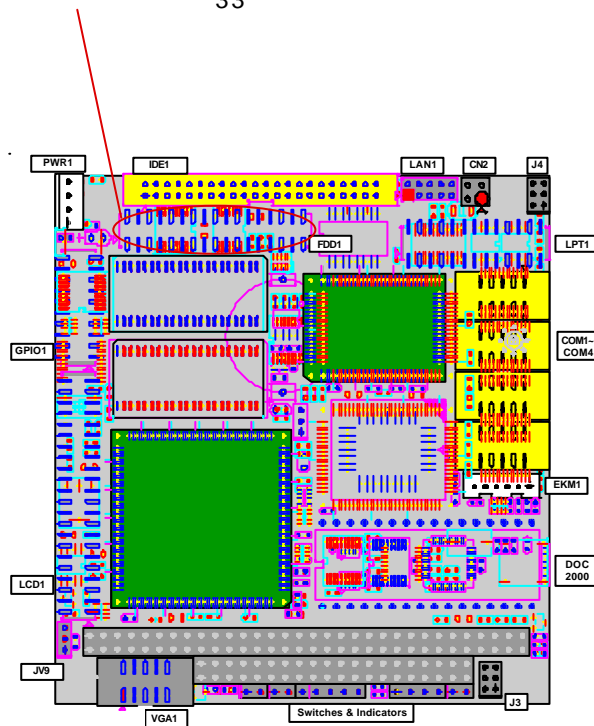

Peripheral Port

Connector : **LPT1**

Type : onboard 26-pin header

Pin	Description	Pin	Description
1	#STROBE	14	#AUTO FEED
2	DATA0	15	#ERROR
3	DATA1	16	#INITIALIZE
4	DATA2	17	#SELECT INPUT
5	DATA3	18	GND
6	DATA4	19	GND
7	DATA5	20	GND
8	DATA6	21	GND
9	DATA7	22	GND
10	#ACKNOWLEDGE	23	GND
11	BUSY	24	GND
12	PAPER EMPTY	25	GND
13	SELECT	26	GND

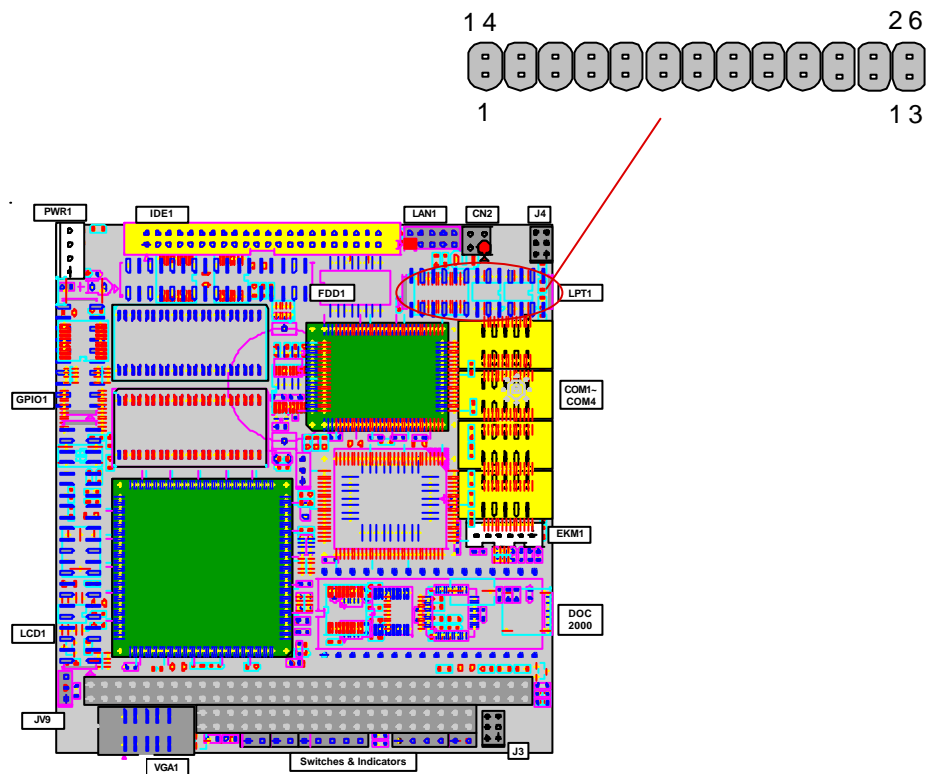

PS/2 Keyboard & Mouse

Connector: **EKM1**

Type: Onboard 6-pin box header

Pin	Description	Pin	Description
1	KB-DATA	2	GND
3	MS-DATA	4	KB-CLK
5	+5V	6	MS-CLK

Note: EKM1 supports PS/2 keyboard directly, and PS/2 mouse supported with the additional PS2 1-to-2 cable in the standard packing.

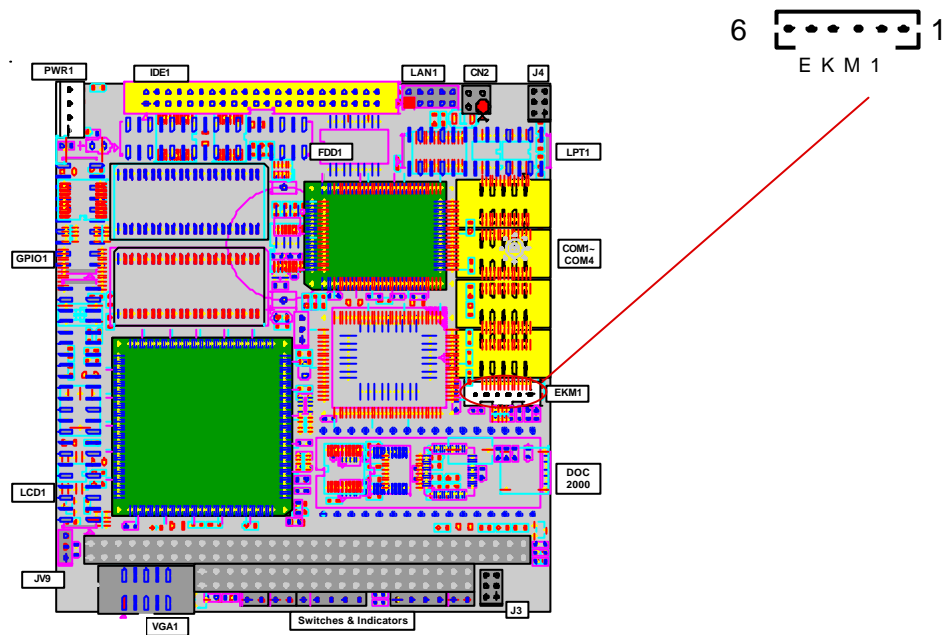

16-bit General Purpose I/O

Connector : **GPIO1**

Type : Onboard 20-pin header

Output Port I/O Based Address : 208hex~20Fh; Pin1~Pin8

Input Port I/O Based Address : 200hex~207h; Pin11~Pin18

Digital Output

Digital Input

Logic Level 0: 0.5V (max)	Logic Level 0: 0.8V (max)
Logic Level 1: 2.0V (min)	Logic Level 1: 2.0V (min)
Output Current per pin: ± 25 mA (max)	

Pin	Description	Pin	Description
1	D00	2	D01
3	D02	4	D03
5	D04	6	D05
7	D06	8	D07
9	GND	10	GND
11	DI0	12	DI1
13	DI2	14	DI3
15	DI4	16	DI5
17	DI6	18	DI7
19	+5V	20	+12V

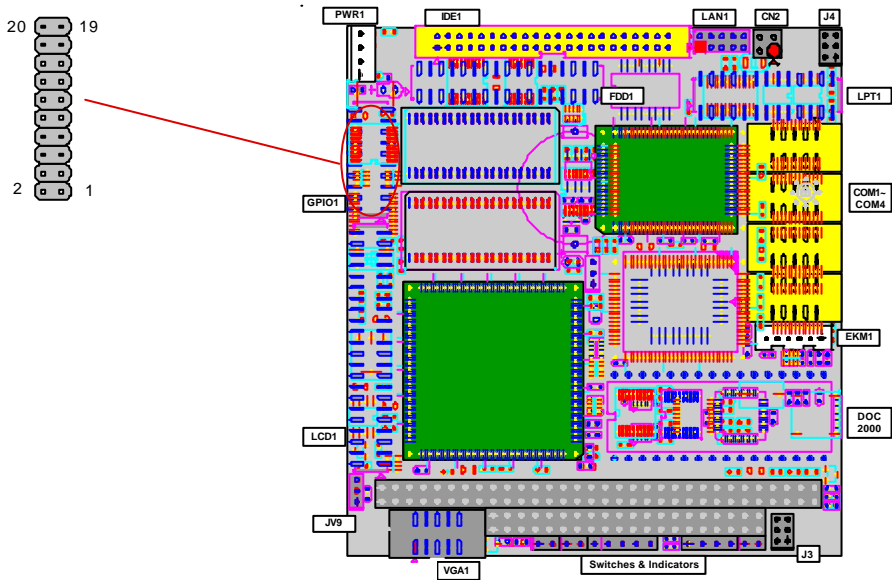

LCD Connector

Connector : **LCD1**

Type : onboard 44-pin header

Pin	Description	Pin	Description
1	Reserved for 12V	2	Reserved for 12V
3	GND	4	GND
5	LCDVDD	6	FPVDDEN
7	VBIAEN	8	GND
9	B0	10	B1
11	B2	12	B3
13	B4	14	B5
15	B6	16	B7
17	G0	18	G1
19	G2	20	G3
21	G4	22	G5
23	G6	24	G7
25	R0	26	R1
27	R2	28	R3
29	R4	30	R5
31	R6	32	R7
33	GND	34	GND
35	FPCLK	36	FP
37	DE	38	LP
39	GND	40	FPEN
41	GND	42	NC
43	VCC	44	VCC

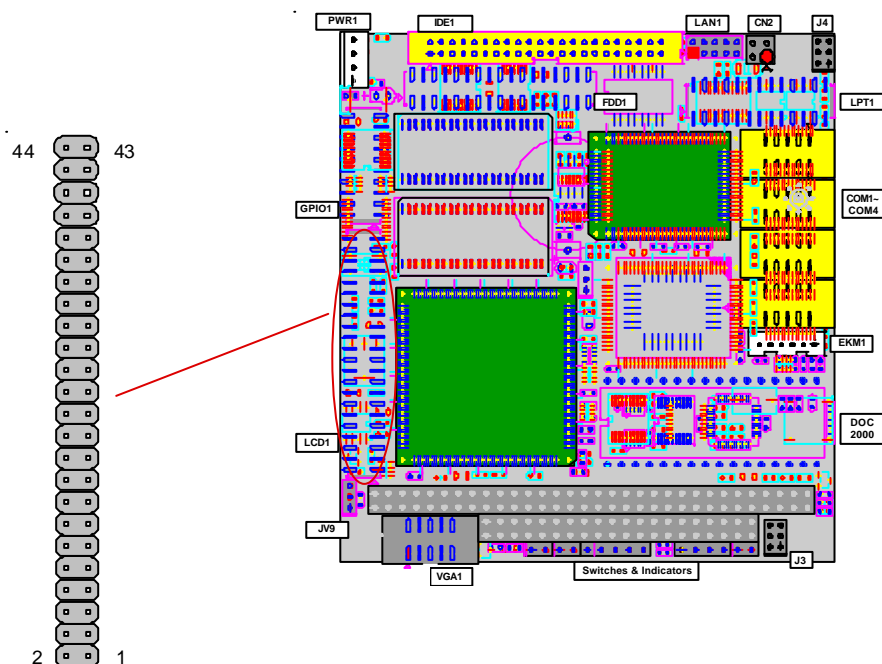

Warranty

This product is warranted to be in good working order for a period of one year from the date of purchase. Should this product fail to be in good working order at any time during this period, we will, at our option, replace or repair it at no additional charge except as set forth in the following terms. This warranty does not apply to products damaged by misuse, modifications, accident or disaster.

Vendor assumes no liability for any damages, lost profits, lost savings or any other incidental or consequential damage resulting from the use, misuse of, or inability to use this product. Vendor will not be liable for any claim made by any other related party.

Return authorization must be obtained from the vendor before returned merchandise will be accepted. Authorization can be obtained by calling or faxing the vendor and requesting a Return Merchandise Authorization (RMA) number. Returned goods should always be accompanied by a clear problem description.

