

**User Manual**

# **ARK-1122**

**Fanless Embedded Box PC**

---

## Attention!

This package contains a hard-copy user manual in Chinese for China CCC certification purposes, and there is an English user manual included as a PDF file on the CD. Please disregard the printed Chinese copy of the user manual if the product is not to be sold and/or installed in China.

## Copyright

The documentation and the software included with this product are copyrighted 2014 by Advantech Co., Ltd. All rights are reserved. Advantech Co., Ltd. reserves the right to make improvements in the products described in this manual at any time without notice. No part of this manual may be reproduced, copied, translated or transmitted in any form or by any means without the prior written permission of Advantech Co., Ltd. Information provided in this manual is intended to be accurate and reliable. However, Advantech Co., Ltd. assumes no responsibility for its use, nor for any infringements of the rights of third parties, which may result from its use.

## Acknowledgements

Award is a trademark of Award Software International, Inc.

VIA is a trademark of VIA Technologies, Inc.

IBM, PC/AT, PS/2 and VGA are trademarks of International Business Machines Corporation.

Intel® and Pentium® are trademarks of Intel Corporation.

Microsoft Windows® is a registered trademark of Microsoft Corp.

RTL is a trademark of Realtek Semi-Conductor Co., Ltd.

ESS is a trademark of ESS Technology, Inc.

UMC is a trademark of United Microelectronics Corporation.

SMI is a trademark of Silicon Motion, Inc.

Creative is a trademark of Creative Technology LTD.

CHRONTEL is a trademark of Chrontel Inc.

All other product names or trademarks are properties of their respective owners.

For more information about this and other Advantech products, please visit our website at:

<http://www.emacinc.com/>

For technical support and service, please visit our support website at:

<http://www.emacinc.com/support/>

---

## Product Warranty (2 years)

Advantech warrants to you, the original purchaser, that each of its products will be free from defects in materials and workmanship for two years from the date of purchase.

This warranty does not apply to any products which have been repaired or altered by persons other than repair personnel authorized by Advantech, or which have been subject to misuse, abuse, accident or improper installation. Advantech assumes no liability under the terms of this warranty as a consequence of such events.

Because of Advantech's high quality-control standards and rigorous testing, most of our customers never need to use our repair service. If an Advantech product is defective, it will be repaired or replaced at no charge during the warranty period. For out-of-warranty repairs, you will be billed according to the cost of replacement materials, service time and freight. Please consult your dealer for more details.

If you think you have a defective product, follow these steps:

1. Collect all the information about the problem encountered. (For example, CPU speed, Advantech products used, other hardware and software used, etc.) Note anything abnormal and list any onscreen messages you get when the problem occurs.
2. Call your dealer and describe the problem. Please have your manual, product, and any helpful information readily available.
3. If your product is diagnosed as defective, obtain an RMA (return merchandise authorization) number from your dealer. This allows us to process your return more quickly.
4. Carefully pack the defective product, a fully-completed Repair and Replacement Order Card and a photocopy proof of purchase date (such as your sales receipt) in a shippable container. A product returned without proof of the purchase date is not eligible for warranty service.
5. Write the RMA number visibly on the outside of the package and ship it prepaid to your dealer.

## Declaration of Conformity

### FCC Class A

Note: This equipment has been tested and found to comply with the limits for a Class A digital device, pursuant to part 15 of the FCC Rules. These limits are designed to provide reasonable protection against harmful interference when the equipment is operated in a commercial environment. This equipment generates, uses, and can radiate radio frequency energy and, if not installed and used in accordance with the instruction manual, may cause harmful interference to radio communications. Operation of this equipment in a residential area is likely to cause harmful interference in which case the user will be required to correct the interference at his own expense.

## Technical Support and Assistance

1. Visit the Advantech web site at [www.advantech.com/support](http://www.advantech.com/support) where you can find the latest information about the product.
2. Contact your distributor, sales representative, or Advantech's customer service center for technical support if you need additional assistance. Please have the following information ready before you call:
  - Product name and serial number
  - Description of your peripheral attachments
  - Description of your software (operating system, version, application software, etc.)
  - A complete description of the problem
  - The exact wording of any error messages

## Warnings, Cautions and Notes

**Warning!** *Warnings indicate conditions, which if not observed, can cause personal injury!*



**Caution!** *Cautions are included to help you avoid damaging hardware or losing data.*



**Note!** *Notes provide optional additional information.*



---

## Safety Instructions

1. Read these safety instructions carefully.
2. Keep this User Manual for later reference.
3. Disconnect this equipment from any AC outlet before cleaning. Use a damp cloth. Do not use liquid or spray detergents for cleaning.
4. For plug-in equipment, the power outlet socket must be located near the equipment and must be easily accessible.
5. Keep this equipment away from humidity.
6. Put this equipment on a reliable surface during installation. Dropping it or letting it fall may cause damage.
7. The openings on the enclosure are for air convection. Protect the equipment from overheating. **DO NOT COVER THE OPENINGS.**
8. Make sure the voltage of the power source is correct before connecting the equipment to the power outlet.
9. Position the power cord so that people cannot step on it. Do not place anything over the power cord.
10. All cautions and warnings on the equipment should be noted.
11. If the equipment is not used for a long time, disconnect it from the power source to avoid damage by transient overvoltage.
12. Never pour any liquid into an opening. This may cause fire or electrical shock.
13. Never open the equipment. For safety reasons, the equipment should be opened only by qualified service personnel.
14. If one of the following situations arises, get the equipment checked by service personnel:
  - The power cord or plug is damaged.
  - Liquid has penetrated into the equipment.
  - The equipment has been exposed to moisture.
  - The equipment does not work well, or you cannot get it to work according to the user's manual.
  - The equipment has been dropped and damaged.
  - The equipment has obvious signs of breakage.
15. **DO NOT LEAVE THIS EQUIPMENT IN AN ENVIRONMENT WHERE THE STORAGE TEMPERATURE MAY GO BELOW -20° C (-4° F) OR ABOVE 60° C (140° F). THIS COULD DAMAGE THE EQUIPMENT. THE EQUIPMENT SHOULD BE IN A CONTROLLED ENVIRONMENT.**
16. **CAUTION: DANGER OF EXPLOSION IF BATTERY IS INCORRECTLY REPLACED. REPLACE ONLY WITH THE SAME OR EQUIVALENT TYPE RECOMMENDED BY THE MANUFACTURER, DISCARD USED BATTERIES ACCORDING TO THE MANUFACTURER'S INSTRUCTIONS.**
17. **CAUTION:** Any unverified component could cause unexpected damage. To ensure the correct installation, please always use the components (ex. screws) provided with the accessory box.
18. **CAUTION:** The computer is provided with a battery-powered real-time clock circuit. There is a danger of explosion if battery is incorrectly replaced. Replace only with same or equivalent type recommended by the manufacture. Discard used batteries according to the manufacturers instructions.
19. **CAUTION:** Always completely disconnect the power cord from your chassis whenever you work with the hardware. Do not make connections while the power is on. Sensitive electronic components can be damaged by sudden power surges.

The sound pressure level at the operator's position according to IEC 704-1:1982 is no more than 70 dB (A).

DISCLAIMER: This set of instructions is given according to IEC 704-1. Advantech disclaims all responsibility for the accuracy of any statements contained herein.

## Packing list

Before installation, please ensure the following items have been shipped:

- 1 x ARK-1122 unit
- 1 x Driver/Utility CD
- 1 x DC 12V Power Adapter
- 1 x Chinese user manual
- 1 x China RoHS
- 1 x 2-year warranty card

## Ordering Information

Model Number	Description
ARK-1122H-S6A1E	Intel® Atom™ N2600 1.6 GHz w/ VGA + HDMI dual display
ARK-1122C-S6A1E	Intel® Atom™ N2600 1.6 GHz w/ 4 COM + Wi-Fi expansion
ARK-1122F-S8A1E	Intel® Atom™ N2800 1.86 GHz w/ 2 Gbe LAN + 3 G Expansion

## Optional Accessories

Part Number	Description
1700001524	Power Cable 3-pin 180 cm, USA Type
170203183C	Power Cable 3-pin 180 cm, Europe Type
170203180A	Power Cable 3-pin 180 cm, UK Type
1700008921	Power Cable 3-pin 180 cm, PSE Mark
1960052227N001	VESA/Desk mounting plate for ARK-1122
9666112000E	DIN Rail mounting kits for ARK-112X series





# Contents

<b>Chapter 1</b>	<b>General Introduction .....</b>	<b>1</b>
1.1	Introduction .....	2
1.2	Features .....	2
1.3	Specifications .....	2
1.3.1	General .....	2
1.3.2	Display .....	3
1.3.3	Ethernet .....	3
1.3.4	Power Consumption.....	3
1.3.5	Power Requirement .....	3
1.4	Environmental Specifications .....	3
1.5	Mechanical Specifications .....	4
1.5.1	ARK-1122H Dimensions .....	4
	Figure 1.1 ARK-1122H mechanical dimension drawing .....	4
1.5.2	ARK-1122C Dimensions .....	5
	Figure 1.2 ARK-1122C mechanical dimension drawing .....	5
1.5.3	ARK-1122F Dimensions .....	6
	Figure 1.3 ARK-1122F mechanical dimension drawing.....	6
<b>Chapter 2</b>	<b>Hardware installation .....</b>	<b>7</b>
2.1	Introduction .....	8
2.2	Jumpers .....	8
2.2.1	Jumper list.....	8
	Table 2.1: Jumper List.....	8
2.2.2	Jumper Settings .....	8
	Table 2.2: J1: AT / ATX Power Selection .....	8
2.2.3	Jumper Description .....	8
2.3	ARK-1122 I/O Indication .....	9
	Figure 2.1 ARK-1122H front view .....	9
	Figure 2.2 ARK-1122H rear view.....	9
	Figure 2.3 ARK-1122C front view .....	10
	Figure 2.4 ARK-1122C rear view.....	10
	Figure 2.5 ARK-1122F front view .....	11
	Figure 2.6 ARK-1122F rear view .....	11
2.4	ARK-1122H External I/O Connectors.....	12
2.4.1	Power ON/OFF Button.....	12
	Figure 2.7 Power ON/OFF Button .....	12
2.4.2	Power Input Connector .....	12
	Figure 2.8 Power Input Connector.....	12
2.4.3	Ethernet Connector (LAN) .....	12
	Figure 2.9 Ethernet Connector .....	12
	Table 2.3: Ethernet Connector Pin Assignments.....	12
2.4.4	VGA Connector.....	13
	Figure 2.10 VGA Connector .....	13
	Table 2.4: VGA Connector Pin Assignments.....	13
2.4.5	USB Connectors .....	13
	Figure 2.11 USB Connector.....	13
	Table 2.5: USB Connector Pin Assignments.....	13
2.4.6	Audio Connector .....	14
	Figure 2.12 Audio Connector.....	14
	Table 2.6: DIO Connector Pin Assignments .....	14
2.4.7	COM Connector .....	14
	Figure 2.13 COM Port Connector .....	14
	Table 2.7: COM Connector Pin Assignments .....	14

	2.4.8	HDMI Connector.....	15
		Figure 2.14 HDMI Connector.....	15
2.5		ARK-1122C External I/O Connectors .....	15
	2.5.1	Power ON/OFF Button.....	15
		Figure 2.15 Power ON/OFF Button .....	15
	2.5.2	Power Input Connector.....	15
		Figure 2.16 Power Input Connector.....	15
	2.5.3	Ethernet Connector (LAN).....	15
		Figure 2.17 Ethernet Connector .....	15
		Table 2.8: Ethernet Connector Pin Assignments .....	16
	2.5.4	VGA Connector.....	16
		Figure 2.18 VGA Connector .....	16
		Table 2.9: VGA Connector Pin Assignments .....	16
	2.5.5	USB Connectors.....	17
		Figure 2.19 USB Connector .....	17
		Table 2.10: USB Connector Pin Assignments.....	17
	2.5.6	Audio Connector.....	17
		Figure 2.20 Audio Connector.....	17
		Table 2.11: DIO Connector Pin Assignments.....	17
	2.5.7	COM Connector.....	18
		Figure 2.21 COM Port Connector.....	18
		Table 2.12: COM Connector Pin Assignments.....	18
2.6		ARK-1122F External I/O Connectors.....	19
	2.6.1	Power ON/OFF Button.....	19
		Figure 2.22 Power ON/OFF Button .....	19
	2.6.2	Power Input Connector.....	19
		Figure 2.23 Power Input Connector.....	19
	2.6.3	Ethernet Connector (LAN).....	19
		Figure 2.24 Ethernet Connector .....	19
		Table 2.13: Ethernet Connector Pin Assignments .....	19
	2.6.4	VGA Connector.....	20
		Figure 2.25 VGA Connector .....	20
		Table 2.14: VGA Connector Pin Assignments .....	20
	2.6.5	USB Connectors.....	20
		Figure 2.26 USB Connector .....	20
		Table 2.15: USB Connector Pin Assignments.....	20
	2.6.6	Audio Connector.....	21
		Figure 2.27 Audio Connector.....	21
		Table 2.16: DIO Connector Pin Assignments.....	21
	2.6.7	COM Connector.....	21
		Figure 2.28 COM Port Connector.....	21
		Table 2.17: COM Connector Pin Assignments.....	21
	2.6.8	HDMI Connector.....	22
		Figure 2.29 HDMI Connector.....	22
	2.6.9	SIM Card Holder.....	22
		Figure 2.30 SIM Card Holder.....	22
2.7		Peripheral Installation .....	22
	2.7.1	HDD Installation (ARK-1122H only).....	22
	2.7.2	mSATA HD Installation.....	25
	2.7.3	RAM Installation.....	27

## Chapter 3 BIOS Settings ..... 29

3.1		Introduction .....	30
		Figure 3.1 Setup program initial screen.....	30
3.2		Entering Setup .....	31
	3.2.1	Main Setup.....	31
		Figure 3.2 Main Setup Screen.....	31
	3.2.2	Advanced BIOS Features Setup.....	32

Figure 3.3	Advanced BIOS Features Setup Screen .....	32
Figure 3.4	ACPI Setting .....	33
Figure 3.5	CPU Configuration Settings.....	34
Figure 3.6	IDE Configuration .....	35
Figure 3.7	Intel Fast Flash Standby .....	36
Figure 3.8	USB Configuration.....	37
Figure 3.9	Super IO Configuration.....	38
Figure 3.10	H/W Monitor.....	39
Figure 3.11	AOAC Configuration .....	40
Figure 3.12	PPM Configuration .....	41
3.2.3	Chipset.....	42
Figure 3.13	Chipset Setup .....	42
Figure 3.14	Chipset Setup .....	42
Figure 3.15	Chipset Setup .....	43
3.2.4	Boot.....	44
Figure 3.16	Boot Setup.....	44
3.2.5	Security Settings .....	45
Figure 3.17	Security Setup .....	45
3.2.6	Save & Exit .....	46
Figure 3.18	Save & Exit Setup.....	46

## **Appendix A**      **WDT & GPIO Sample Code .....49**

A.1	Watchdog Timer Sample Code .....	50
-----	----------------------------------	----



# Chapter 1

## General Introduction

This chapter gives background information on ARK-1122 series.

## 1.1 Introduction

The ARK-1122 fanless Embedded Box Computer is an ideal, application-ready system platform solution. All electronics are protected in a compact, sealed, aluminum case for easy embedding in the customer's own housing, or as a stand-alone application where space is limited and the environment harsh.

The solid, sealed aluminum case offers vibration and dust resistance while also providing a passive cooling solution. The ARK-1122 provides system integrators with a turn-key solution and versatile application development path without breaking the bank or missing time-to-market deadlines.

ARK-1122 is designed as a palm-size fanless embedded system and occupies only 133.8 x 43.1 x 94.2 mm (5.27" x 1.70" x 3.71"). The rugged, cast aluminum case not only provides great protection from EMI, shock/vibration, cold and heat, but also passive cooling for quiet, fanless operation. ARK-1122 meets demands by offering up to 1 x VGA, 1 x HDMI, 2 x Giga LAN, 4 x USB 2.0 ports, and 4 x COM ports (by SKU); all packed into a compact rugged unit and powered by an Intel® Atom™ N2600/N2800 processor. ARK-1122 also supports both 2.5" SATA HDD, mSATA and SSD for storage options (by SKU) even though it is a palm-size system. Besides, ARK-1122 is a low-power-consumption system and it is powered by DC 12 V input. The ARK-1122 provides for diversified application fields.

## 1.2 Features

### Key features

- Extremely compact, sealed construction with fanless operation, supports Intel® Atom™ N2600 1.6 GHz / N2800 1.86 GHz CPU
- Ultra slim palm-size system with 2.5" SATA HDD/SSD/mSATA support (by SKU)
- Low power consumption system
- Support VESA/desk/DIN-rail mountings

## 1.3 Specifications

### 1.3.1 General

- **CPU:** Intel® Atom™ Dual Core Processor N2600 1.6 GHz/N2800 1.86 GHz
- **System Chipset:** Intel® NM10 Express Chipset
- **BIOS:** AMI 16 Mbit Flash BIOS
- **System Memory:** Up to 4G DD3 1066GHz SDRAM SODIMM
- **Watchdog Timer:** 255-level interval timer, setup by software
- **Serial Ports:**
  - 1 x RS232 (for ARK-1122H & ARK-1122F)
  - 2 x RS-232, 2 x RS-232/422/485 with auto flow control (for ARK-1122C)
- **USB:**
  - 4 x USB 2.0 compliant Ports (for ARK-1122H & ARK-1122C)
  - 3 x USB 2.0 compliant Ports (for ARK-1122F)
- **Audio:** High Definition Audio Codec - Realtek ALC892, with Line-in, Line-out (ARK-1122H & ARK-1122F)
- **Expansion Interface:** Support up to 1 x half size Mini-PCIe & 1 x full size Mini-PCIe (ARK-1122F only)
- **Storage:**
  - Supports SSD or 1 x 2.5" SATAII HDD (9.5 mm height only)

- Support mSATA HDD device
- SATA: Support 1 x 2.5" SATAII HDD (9.5 mm height only)

### 1.3.2 Display

- **Chipset:** Intel® Atom N2600/N2800
- **Display Memory:** Intel® NM10 Express Chipset
- **VGA Resolution:** Supports up to 1920 x 1200 HDMI

### 1.3.3 Ethernet

- **Chipset:** Intel® 82567V
- **Speed:** 10/100/1000 Mbps, support Wake on LAN
- **Interface:** Up to 2 x RJ45 (ARK-1122F)
- **Standard:** Compliant with IEEE 802.3, IEEE 802.3u, IEEE 802.3x, IEEE 8023y, IEEE 802.ab.

### 1.3.4 Power Consumption

- **Input Voltage:** DC 12V
- **Power Adapter:** AC to DC 12 V/3 A, 36 W

### 1.3.5 Power Requirement

- **System power:**
  - Minimum power input: DC 12 V 1.5 A
- **RTC battery:** 3 V/210 mAh

## 1.4 Environmental Specifications

- **Operating temperature:** -20 ~ 60° C (With extended temperature SSD/mSATA devices) & 0 ~ 40° C (With standard temperature HDD/SSD/mSATA devices)
- **Relative humidity:** 95% @ 40°C (non-condensing)
- **Storage temperature:** -40 ~ 85°C (-40 ~ 185°F)
- **Vibration loading during operation:**
  - With SSD/mSATA: 3 Grms, IEC 60068-2-64, random, 5 ~ 500 Hz, 1 hr/axis
- **Shock during operation:**
  - With SSD/mSATA: 30 G, IEC 60068-2-64, half sine, 11 ms duration
- **Safety:** UL,CB,CCC,BSMI
- **EMC:** CE, FCC Class A, BSMI, CCC

## 1.5 Mechanical Specifications

### 1.5.1 ARK-1122H Dimensions

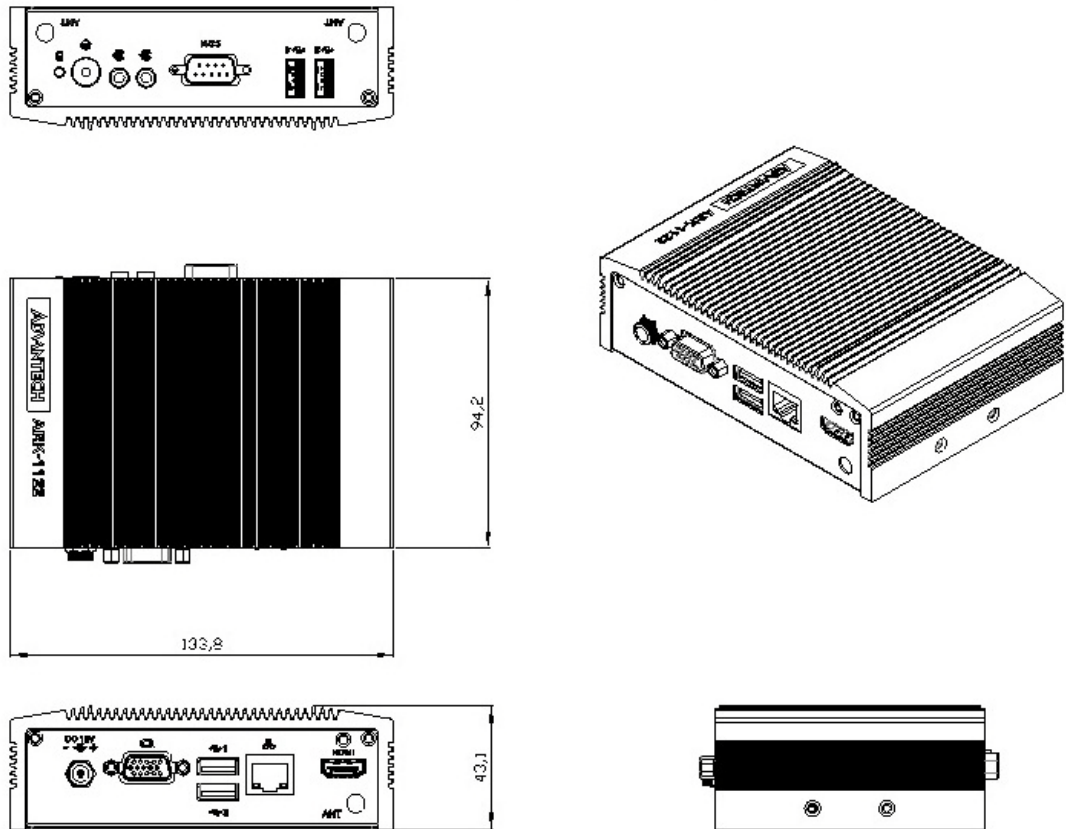

Figure 1.1 ARK-1122H mechanical dimension drawing



## 1.5.2 ARK-1122C Dimensions

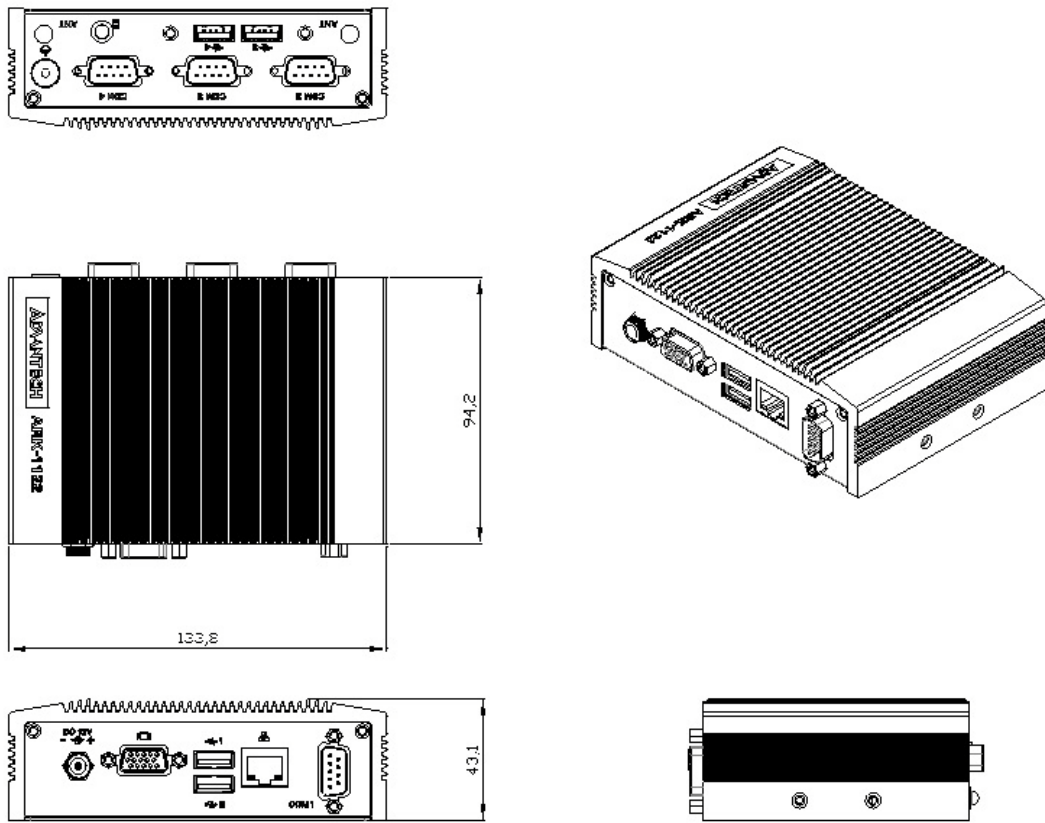

Figure 1.2 ARK-1122C mechanical dimension drawing

### 1.5.3 ARK-1122F Dimensions

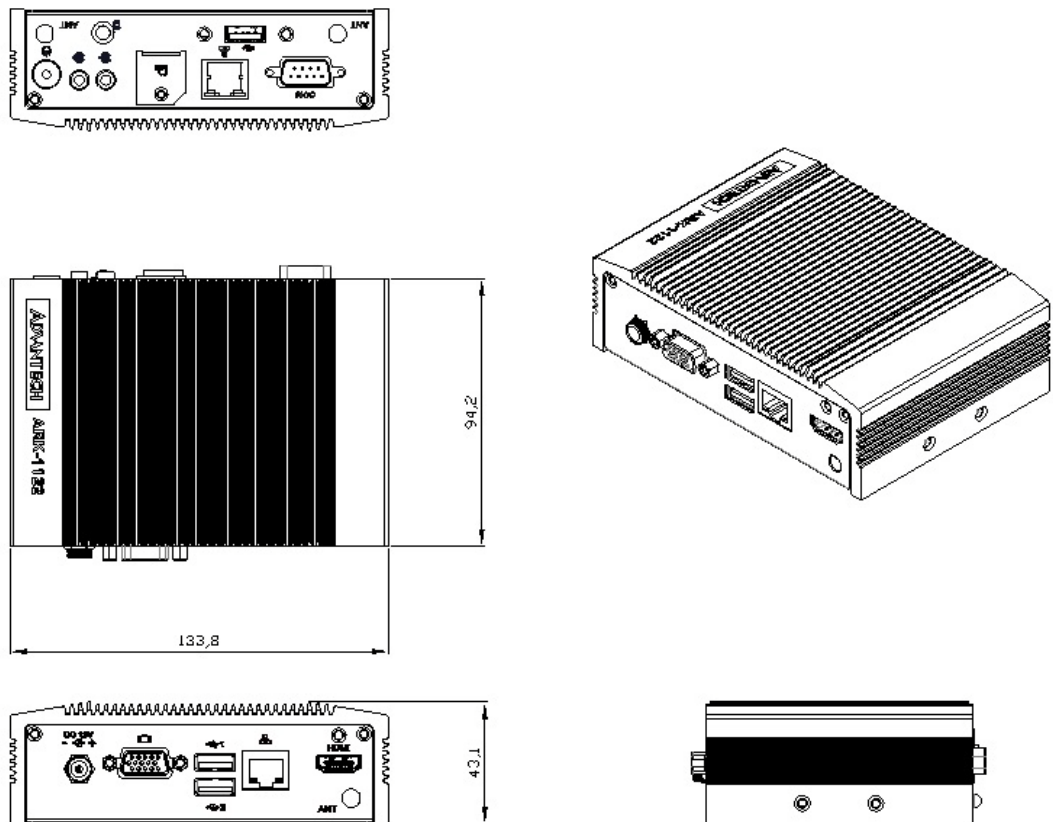

Figure 1.3 ARK-1122F mechanical dimension drawing

# Chapter 2

## Hardware installation

This chapter introduces external IO and the installation of ARK-1122 Hardware.

## 2.1 Introduction

The following sections show the internal jumper settings and the external connectors and pin assignments for applications.

## 2.2 Jumpers

### 2.2.1 Jumper list

**Table 2.1: Jumper List**

J1	AT / ATX Power Selection
----	--------------------------

### 2.2.2 Jumper Settings

**Table 2.2: J1: AT / ATX Power Selection**

<b>Part Number</b>	1653003260
<b>Footprint</b>	HD_3x2P_79
<b>Description</b>	PIN HEADER 3*2P 180D(M) 2.0mm SMD SQUARE PIN
<b>Setting</b>	<b>Function</b>
(5-6) ON	AT power
*(5-6) Empty	ATX power

\* Default setting

### 2.2.3 Jumper Description

Cards can be configured by setting jumpers. A jumper is a metal bridge used to close an electric circuit. It consists of two metal pins and a small metal clip (often protected by a plastic cover) that slides over the pins to connect them. To close a jumper, you connect the pins with the clip. To open a jumper, you remove the clip. Sometimes a jumper will have three pins, labeled 1, 2 and 3. In this case you would connect either pins 1 and 2, or 2 and 3.

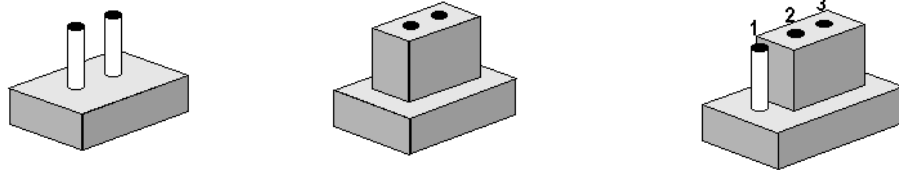

The jumper settings are schematically depicted in this manual as follows.



A pair of needle-nose pliers may be helpful when working with jumpers. If you have any doubts about the best hardware configuration for your application, contact your local distributor or sales representative before you make any changes.

Generally, you simply need a standard cable to make most connections.

**Warning!** To avoid damaging the computer, always turn off the power supply before setting jumpers or clearing CMOS. Before turning on the power supply, make sure CMOS jumper is back to 3.0 V Battery On.



## 2.3 ARK-1122 I/O Indication

ARK-1122H

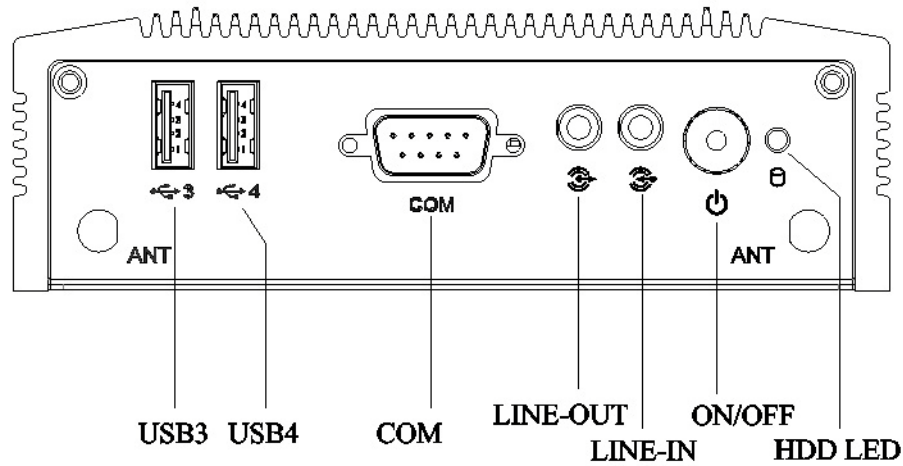

Figure 2.1 ARK-1122H front view

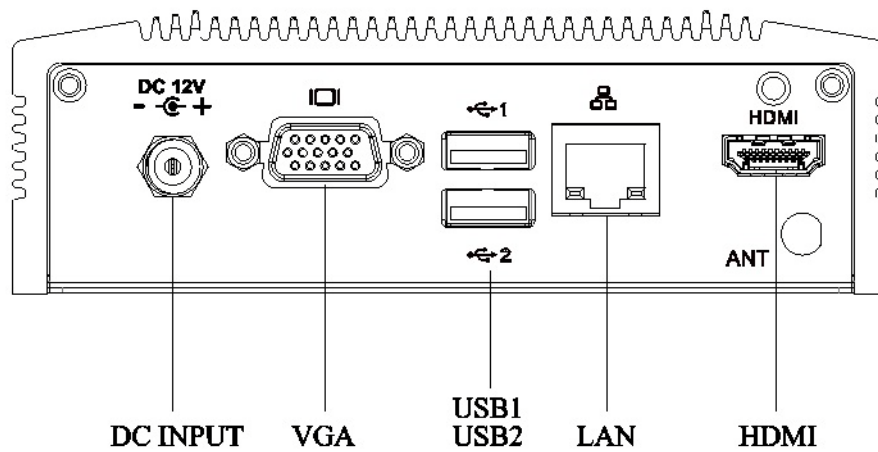

Figure 2.2 ARK-1122H rear view

# ARK-1122C

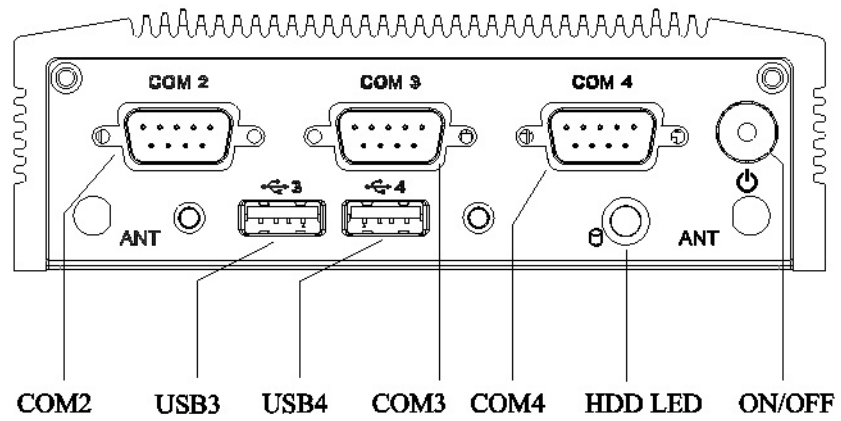

Figure 2.3 ARK-1122C front view

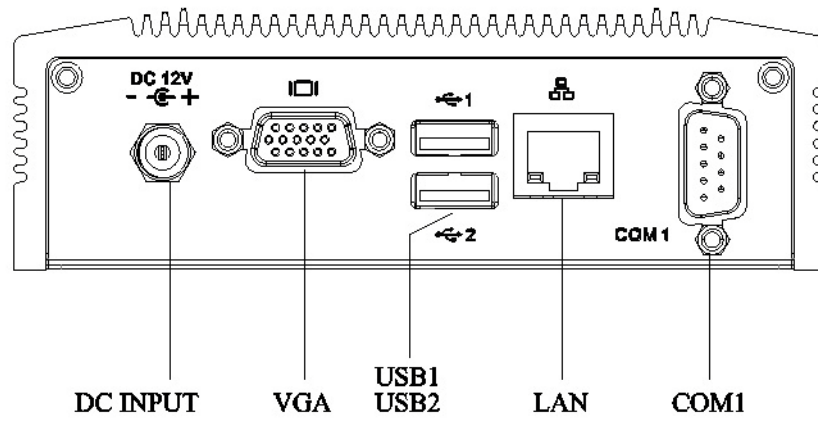

Figure 2.4 ARK-1122C rear view

ARK-1122F

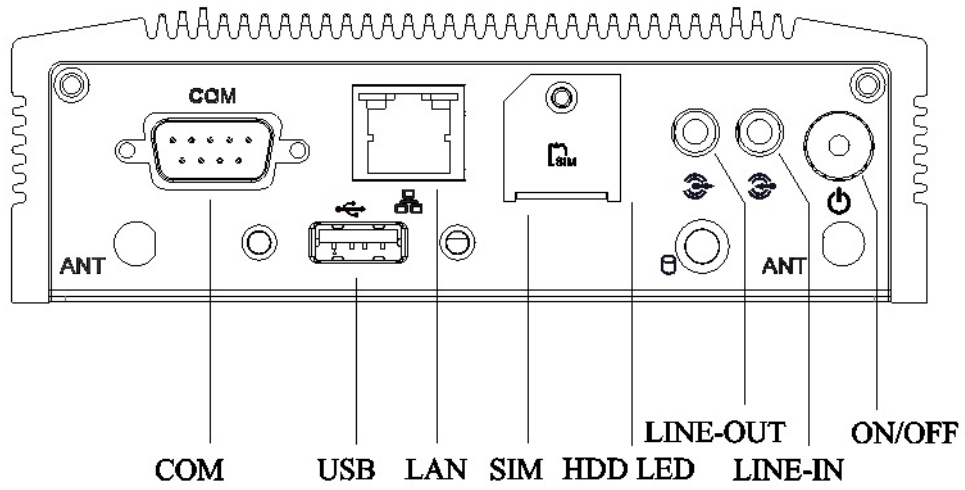

Figure 2.5 ARK-1122F front view

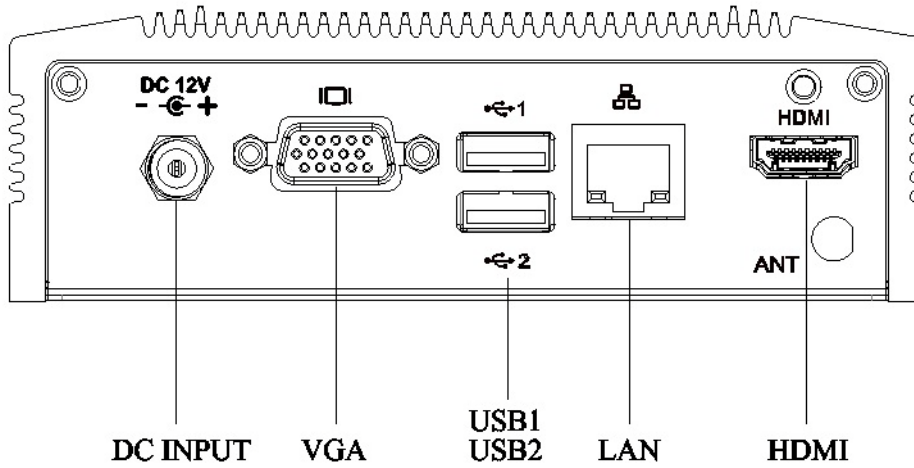

Figure 2.6 ARK-1122F rear view

## 2.4 ARK-1122H External I/O Connectors

### 2.4.1 Power ON/OFF Button

ARK-1122H comes with a Power On/Off button with LED indicators on the front side to show its On status (Green LED) and Off/Suspend status (Orange LED). Dual functions of Soft Power -On/Off (Instant off or Delay 4 Seconds), and Suspend are supported.



Figure 2.7 Power ON/OFF Button

### 2.4.2 Power Input Connector

ARK-1122H comes with a DC-Jack header that carries 12 V<sub>DC</sub> external power input. The bracket makes the power connector very secure.

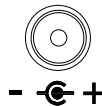

Figure 2.8 Power Input Connector

### 2.4.3 Ethernet Connector (LAN)

ARK-1122H provides one RJ45 LAN interface connector which is fully compliant with IEEE 802.3u 10/100/1000 Mbps CSMA/CD standards. It is equipped with 82567V and support Wake on LAN. The Ethernet port uses a standard RJ-45 jack connector with LED indicators on the front side to show Active/Link status and Speed status.

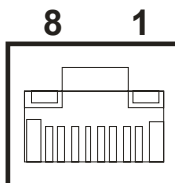

Figure 2.9 Ethernet Connector

Table 2.3: Ethernet Connector Pin Assignments

Pin	10/100/1000 Mbps Signal Name
1	TX+, MDI0+
2	TX-, MDI0-
3	RX+, MDI1+
4	MDI2+
5	MDI2-
6	RX-, MDI1-
7	MDI3+
8	MDI3-



**Note!** NC, if present, means “No Connection”.



### 2.4.4 VGA Connector

The ARK-1122H provides a high resolution VGA interface connected by a D-sub 15-pin connector to support a VGA CRT monitor. It supports display resolution up to 1920 x 1200 HDMI.

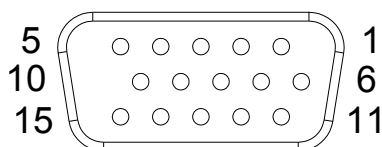

Figure 2.10 VGA Connector

Table 2.4: VGA Connector Pin Assignments

Pin	Signal Name	Pin	Signal Name
1	Red	2	Green
3	Blue	4	NC
5	GND	6	GND
7	GND	8	GND
9	NC	10	GND
11	NC	12	DDC Date
13	H-SYNC	14	V-SYNC
15	DDC Clock		

### 2.4.5 USB Connectors

The ARK-1122H provides four USB interface connectors, which give complete Plug & Play and hot swapping for up to 127 external devices. The USB interface is compliant with USB UHCI, Rev. 2.0. The USB interface supports Plug and Play, which enables you to connect or disconnect a device whenever you want, without turning off the computer.

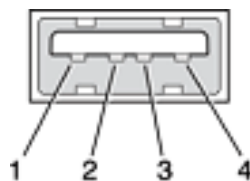

Figure 2.11 USB Connector

Table 2.5: USB Connector Pin Assignments

Pin	Signal Name	Pin	Signal Name
1	VCC	2	USB_data-
3	USB_data+	4	GND

## 2.4.6 Audio Connector

ARK-1122H offers stereo audio ports by two 3.5 ear phone jack connectors of Line\_out and Line\_in. The audio chip controller is ALC892 which is compliant with the Azalea standard.

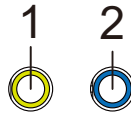

Figure 2.12 Audio Connector

Table 2.6: DIO Connector Pin Assignments

Pin	Signal Name
1	Line-out
2	Line-in

## 2.4.7 COM Connector

ARK-1122H provides one D-sub 9-pin connectors, which offers RS-232 serial communication interface.

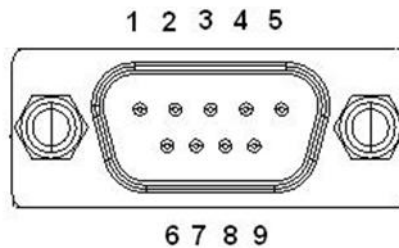

Figure 2.13 COM Port Connector

Table 2.7: COM Connector Pin Assignments

	RS-232	RS-422	RS-485
Pin	Signal Name	Signal Name	Signal Name
1	DCD	Tx-	DATA-
2	RxD	Tx+	DATA+
3	TxD	Rx+	NC
4	DTR	Rx-	NC
5	GND	GND	GND
6	DSR	NC	NC
7	RTS	NC	NC
8	CTS	NC	NC
9	RI	NC	NC

**Note!** NC means “No Connection”.



## 2.4.8 HDMI Connector

An integrated, 19-pin receptacle connector HDMI Type A Interface is provided. The HDMI link supports resolutions up to 1920x1200 @ 60 Hz.

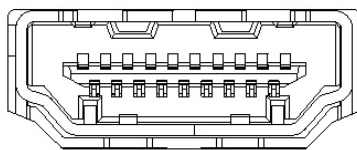

Figure 2.14 HDMI Connector

## 2.5 ARK-1122C External I/O Connectors

### 2.5.1 Power ON/OFF Button

ARK-1122C comes with a Power On/Off button with LED indicators on the front side to show its On status (Green LED) and Off/Suspend status (Orange LED). Dual functions of Soft Power -On/Off (Instant off or Delay 4 Seconds), and Suspend are supported.



Figure 2.15 Power ON/OFF Button

### 2.5.2 Power Input Connector

ARK-1122C comes with a DC-Jack header that carries 12 VDC external power input. The bracket makes the power connector very secure.

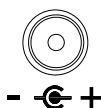

Figure 2.16 Power Input Connector

### 2.5.3 Ethernet Connector (LAN)

ARK-1122C provides one RJ45 LAN interface connector which is fully compliant with IEEE 802.3u 10/100/1000 Mbps CSMA/CD standards. It is equipped with 82567V and support Wake on LAN. The Ethernet port uses a standard RJ-45 jack connector with LED indicators on the front side to show Active/Link status and Speed status.

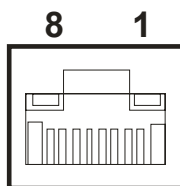

Figure 2.17 Ethernet Connector

**Table 2.8: Ethernet Connector Pin Assignments**

Pin	10/100/1000 Mbps Signal Name
1	TX+, MDI0+
2	TX-, MDI0-
3	RX+, MDI1+
4	MDI2+
5	MDI2-
6	RX-, MDI1-
7	MDI3+
8	MDI3-

**Note!** NC, if present, means “No Connection”.



## 2.5.4 VGA Connector

The ARK-1122C provides a high resolution VGA interface connected by a D-sub 15-pin connector to support a VGA CRT monitor. It supports display resolution up to 1920 x 1200 HDMI.

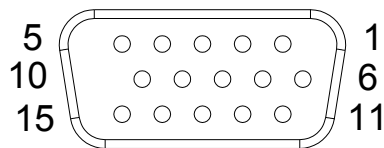

**Figure 2.18 VGA Connector**

**Table 2.9: VGA Connector Pin Assignments**

Pin	Signal Name	Pin	Signal Name
1	Red	2	Green
3	Blue	4	NC
5	GND	6	GND
7	GND	8	GND
9	NC	10	GND
11	NC	12	DDC Date
13	H-SYNC	14	V-SYNC
15	DDC Clock		

## 2.5.5 USB Connectors

The ARK-1122C provides up to four USB interface connectors, which give complete Plug & Play and hot swapping for up to 127 external devices. The USB interface is compliant with USB UHCI, Rev. 2.0. The USB interface supports Plug and Play, which enables you to connect or disconnect a device whenever you want, without turning off the computer.

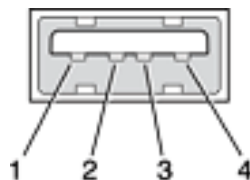

Figure 2.19 USB Connector

Table 2.10: USB Connector Pin Assignments

Pin	Signal Name	Pin	Signal Name
1	VCC	2	USB_data-
3	USB_data+	4	GND

## 2.5.6 Audio Connector

ARK-1122C offers stereo audio ports by two 3.5mm ear phone jack connectors of Line\_out and Line\_in. The audio chip controller is ALC892 which is compliant with the Azalea standard.

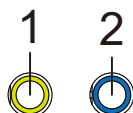

Figure 2.20 Audio Connector

Table 2.11: DIO Connector Pin Assignments

Pin	Signal Name
1	Line-out
2	Line-in

## 2.5.7 COM Connector

ARK-1122C provides four D-sub 9-pin connectors, which offers two RS-232 serial communication interface and two RS-232/422/485 serial communication interface. Default setting is RS-232, and the mode of serial ports are controlled by relay IC. If you would like to use RS-422/485, just need change the BIOS setting. You can find detailed BIOS setting for serial ports in Chapter 3.

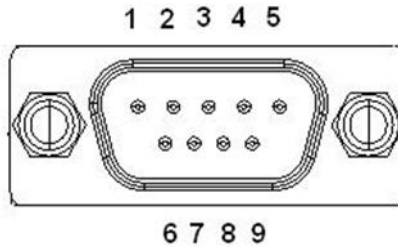

Figure 2.21 COM Port Connector

Table 2.12: COM Connector Pin Assignments

	RS-232	RS-422	RS-485
Pin	Signal Name	Signal Name	Signal Name
1	DCD	Tx-	DATA-
2	RxD	Tx+	DATA+
3	TxD	Rx+	NC
4	DTR	Rx-	NC
5	GND	GND	GND
6	DSR	NC	NC
7	RTS	NC	NC
8	CTS	NC	NC
9	RI	NC	NC

**Note!** NC means “No Connection”.



## 2.6 ARK-1122F External I/O Connectors

### 2.6.1 Power ON/OFF Button

ARK-1122F comes with a Power On/Off button with LED indicators on the front side to show its On status (Green LED) and Off/Suspend status (Orange LED). Dual functions of Soft Power -On/Off (Instant off or Delay 4 Seconds), and Suspend are supported.



Figure 2.22 Power ON/OFF Button

### 2.6.2 Power Input Connector

ARK-1122F comes with a DC-Jack header that carries 12 VDC external power input. The bracket makes the power connector very secure.

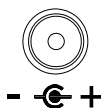

Figure 2.23 Power Input Connector

### 2.6.3 Ethernet Connector (LAN)

ARK-1122F provides two RJ45 LAN interface connector which is fully compliant with IEEE 802.3u 10/100/1000 Mbps CSMA/CD standards. It is equipped with 82567V and support Wake on LAN. The Ethernet port uses a standard RJ-45 jack connector with LED indicators on the front side to show Active/Link status and Speed status.

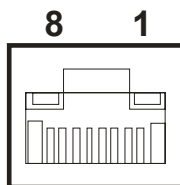

Figure 2.24 Ethernet Connector

Table 2.13: Ethernet Connector Pin Assignments

Pin	10/100/1000 Mbps Signal Name
1	TX+, MDI0+
2	TX-, MDI0-
3	RX+, MDI1+
4	MDI2+
5	MDI2-
6	RX-, MDI1-
7	MDI3+
8	MDI3-

**Note!** NC, if present, means “No Connection”.



## 2.6.4 VGA Connector

The ARK-1122F provides a high resolution VGA interface connected by a D-sub 15-pin connector to support a VGA CRT monitor. It supports display resolution up to 1920 x 1200 HDMI.

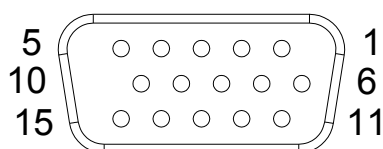

Figure 2.25 VGA Connector

Table 2.14: VGA Connector Pin Assignments

Pin	Signal Name	Pin	Signal Name
1	Red	2	Green
3	Blue	4	NC
5	GND	6	GND
7	GND	8	GND
9	NC	10	GND
11	NC	12	DDC Date
13	H-SYNC	14	V-SYNC
15	DDC Clock		

## 2.6.5 USB Connectors

The ARK-1122F provides three USB interface connectors, which give complete Plug & Play and hot swapping for up to 127 external devices. The USB interface is compliant with USB UHCI, Rev. 2.0. The USB interface supports Plug and Play, which enables you to connect or disconnect a device whenever you want, without turning off the computer.

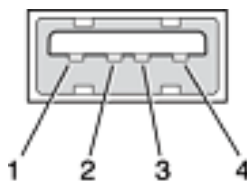

Figure 2.26 USB Connector

Table 2.15: USB Connector Pin Assignments

Pin	Signal Name	Pin	Signal Name
1	VCC	2	USB_data-
3	USB_data+	4	GND



## 2.6.6 Audio Connector

ARK-1122F offers stereo audio ports by two 3.5 ear phone jack connectors of Line\_out and Line\_in. The audio chip controller is ALC892 which is compliant with the Azalea standard.

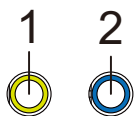

Figure 2.27 Audio Connector

Table 2.16: DIO Connector Pin Assignments

Pin	Signal Name
1	Line-out
2	Line-in

## 2.6.7 COM Connector

ARK-1122F provides one D-sub 9-pin connectors, which offers RS-232 serial communication interface.

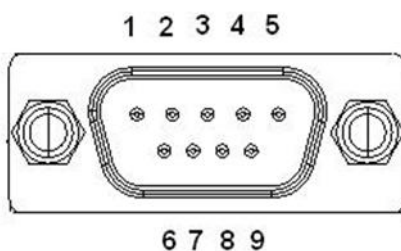

Figure 2.28 COM Port Connector

Table 2.17: COM Connector Pin Assignments

Pin	RS-232 Signal Name	RS-422 Signal Name	RS-485 Signal Name
1	DCD	Tx-	DATA-
2	RxD	Tx+	DATA+
3	TxD	Rx+	NC
4	DTR	Rx-	NC
5	GND	GND	GND
6	DSR	NC	NC
7	RTS	NC	NC
8	CTS	NC	NC
9	RI	NC	NC

**Note!** NC means “No Connection”.



## 2.6.8 HDMI Connector

An integrated, 19-pin receptacle connector HDMI Type A Interface is provided. The HDMI link supports resolutions up to 1920 x 1200 @ 60 Hz.

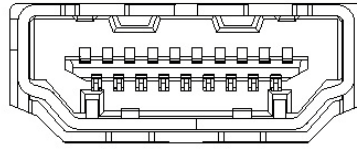

Figure 2.29 HDMI Connector

## 2.6.9 SIM Card Holder

ARK-1122F provides a SIM card Holder for internet connection.

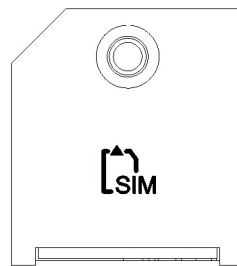
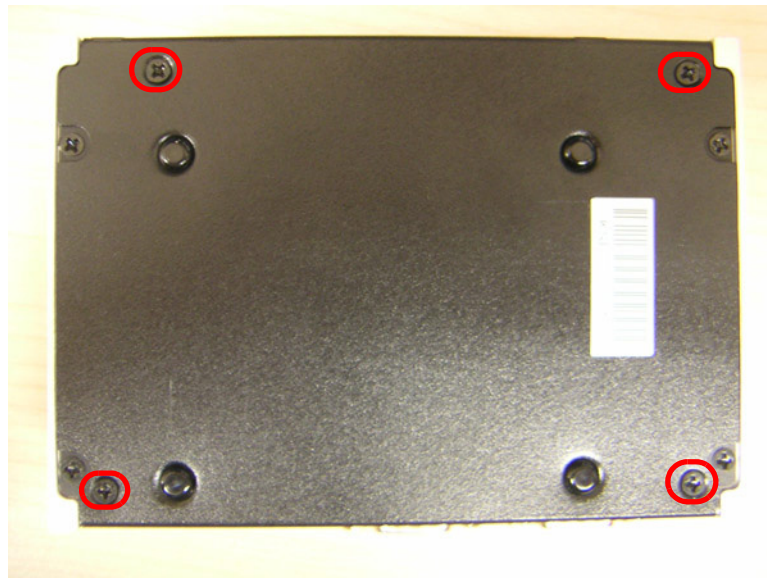

Figure 2.30 SIM Card Holder

## 2.7 Peripheral Installation

### 2.7.1 HDD Installation (ARK-1122H only)

1. Unscrew the bottom cover screws. (marked with "HDD")



2. Remove the four SNAP RIVETs from the bottom cover.

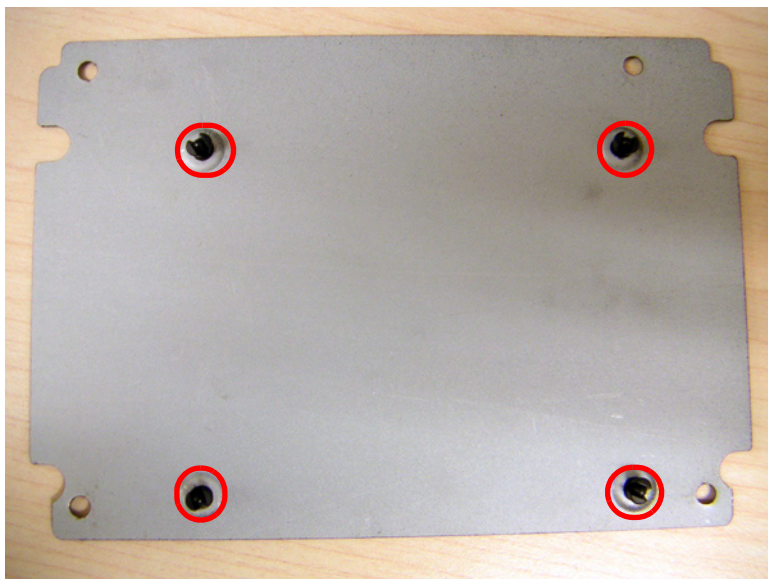

3. Secure 2.5" SATA HDD onto the bottom cover. The screws are in the accessory box.



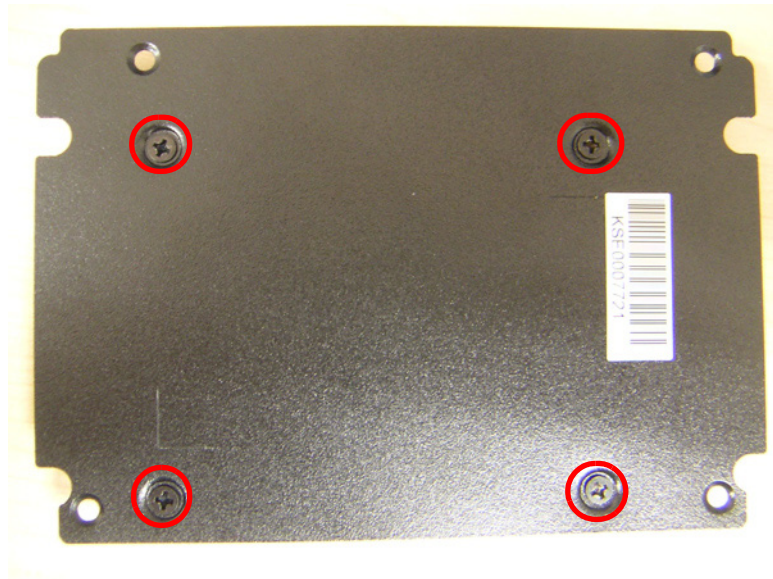

4. Connect SATA signal and power cable to the 2.5" SATA HDD.

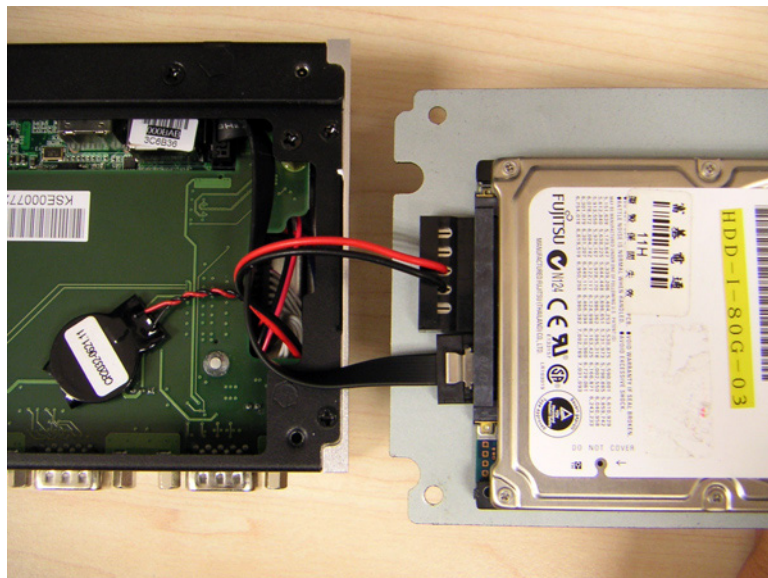



5. Secure the bottom cover in its original position.

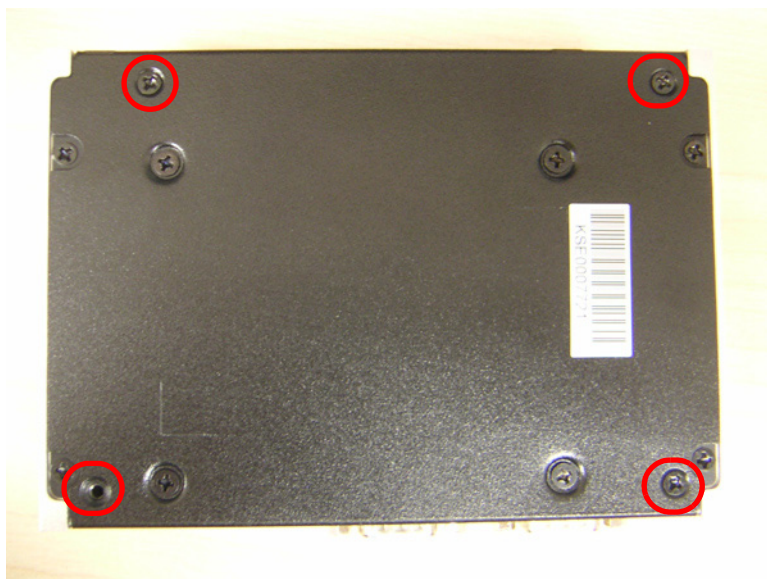

### 2.7.2 mSATA HD Installation

**\*\* Below installation is for ARK-1122H & ARK-1122C ONLY, NOT for ARK-1122F. For ARK-1122F, we suggest to install by CTOS due to complex installation.**

1. Unscrew the bottom cover screws.

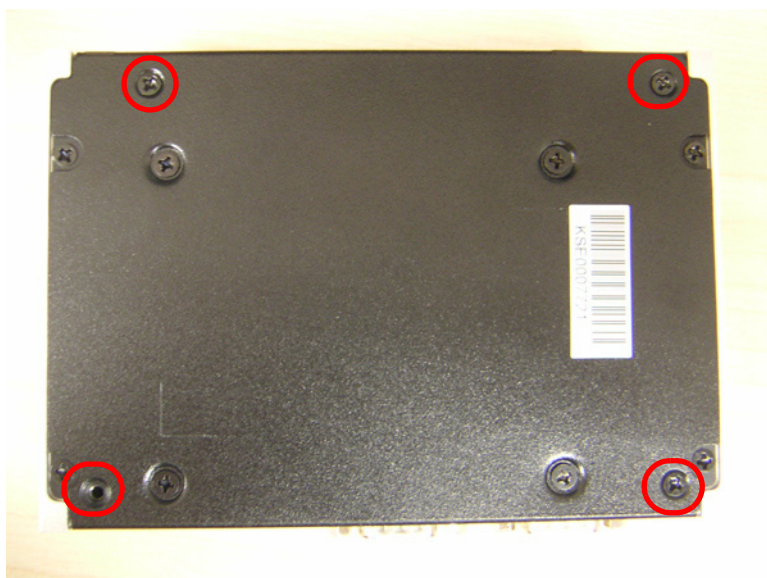

2. Insert mSTAT HD into the slot and secure the screw to fix the mSATA HD.



3. Secure the original screw.

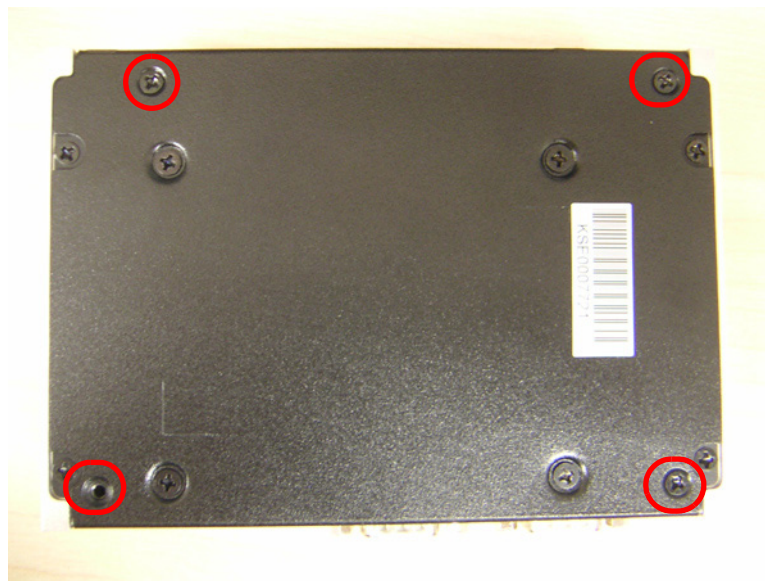

### 2.7.3 RAM Installation

1. Unscrew the four screws on bottom cover. (marked with "RAM")



2. Unscrew the four screws on the sides of ARK-1122.





3. Unscrew the four screws on the front/rear face plate of ARK-1122.



4. Remove aluminum top chassis and install RAM.

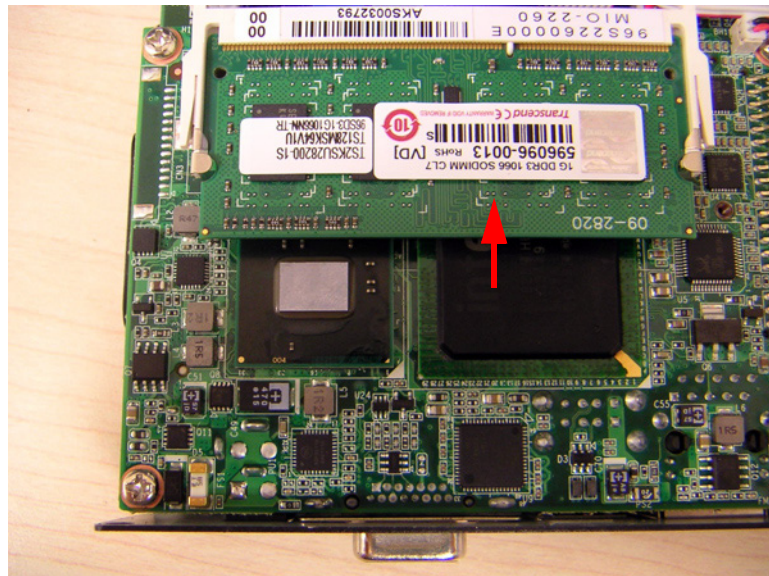

5. Replace the aluminum top chassis and secure all screws.



# Chapter 3

## BIOS Settings

This chapter introduces how to set BIOS configuration data.

## 3.1 Introduction

AMIBIOS has been integrated into a plethora of motherboards for a couple decades. With the AMIBIOS Setup program, users can modify BIOS settings and control various system features. This chapter describes the basic navigation of the ARK-1122 BIOS setup screens.



**Figure 3.1 Setup program initial screen**

AMI's BIOS ROM has a built-in Setup program that allows users to modify the basic system configuration. This information is stored in flash ROM so it retains the Setup information when the power is turned off.

## 3.2 Entering Setup

Turn on the computer and then press <F2> or <DEL> to enter Setup menu.

### 3.2.1 Main Setup

When users first enter the BIOS Setup Utility, users will enter the Main setup screen. Users can always return to the Main setup screen by selecting the Main tab. There are two Main Setup options. They are described in this section. The Main BIOS Setup screen is shown below.



**Figure 3.2 Main Setup Screen**

The Main BIOS setup screen has two main frames. The left frame displays all the options that can be configured. Grayed-out options cannot be configured; options in blue can. The right frame displays the key legend. Above the key legend is an area reserved for a text message. When an option is selected in the left frame, it is highlighted in white. Often a text message will accompany it.

- **System Time / System Date**

Use this option to change the system time and date. Highlight System Time or System Date using the <Arrow> keys. Enter new values through the keyboard. Press the <Tab> key or the <Arrow> keys to move between fields. The date must be entered in MM/DD/YY format. The time must be entered in HH:MM:SS format.

### 3.2.2 Advanced BIOS Features Setup

Select the Advanced tab from the ARK-1122 setup screen to enter the Advanced BIOS Setup screen. You can select any of the items in the left frame of the screen, such as CPU Configuration, to go to the sub menu for that item. You can display an Advanced BIOS Setup option by highlighting it using the <arrow> keys, and smacking <enter>. All Advanced BIOS Setup options are described in this section. The Advanced BIOS Setup screens are shown below. The sub menus are described on the following pages.

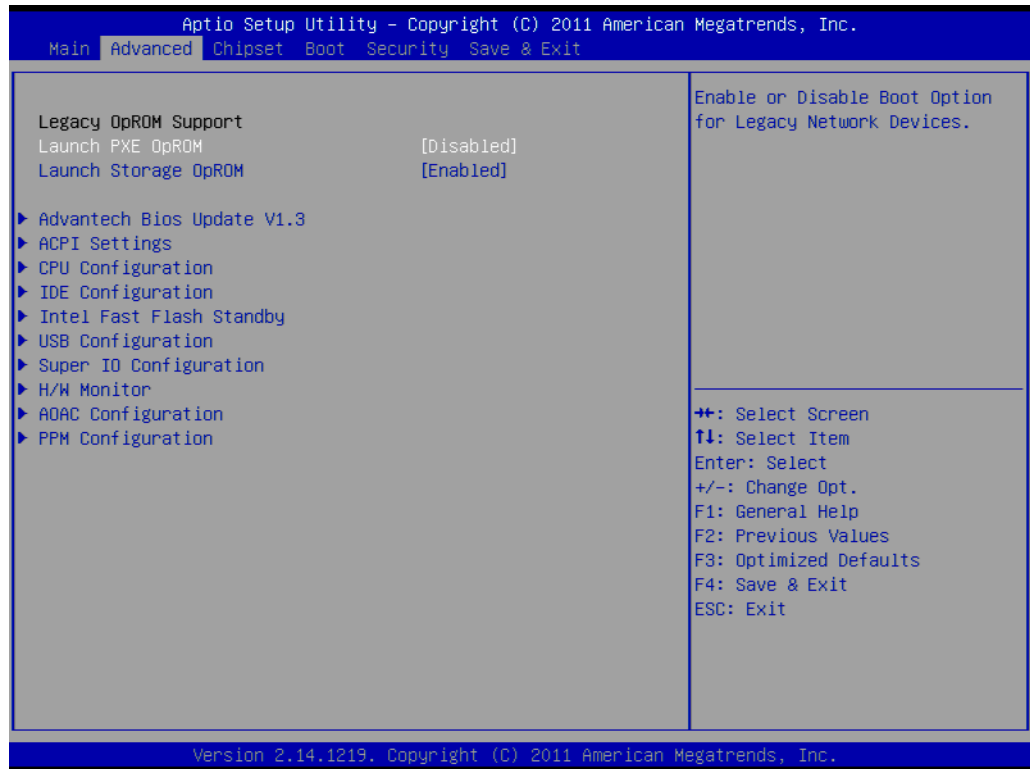
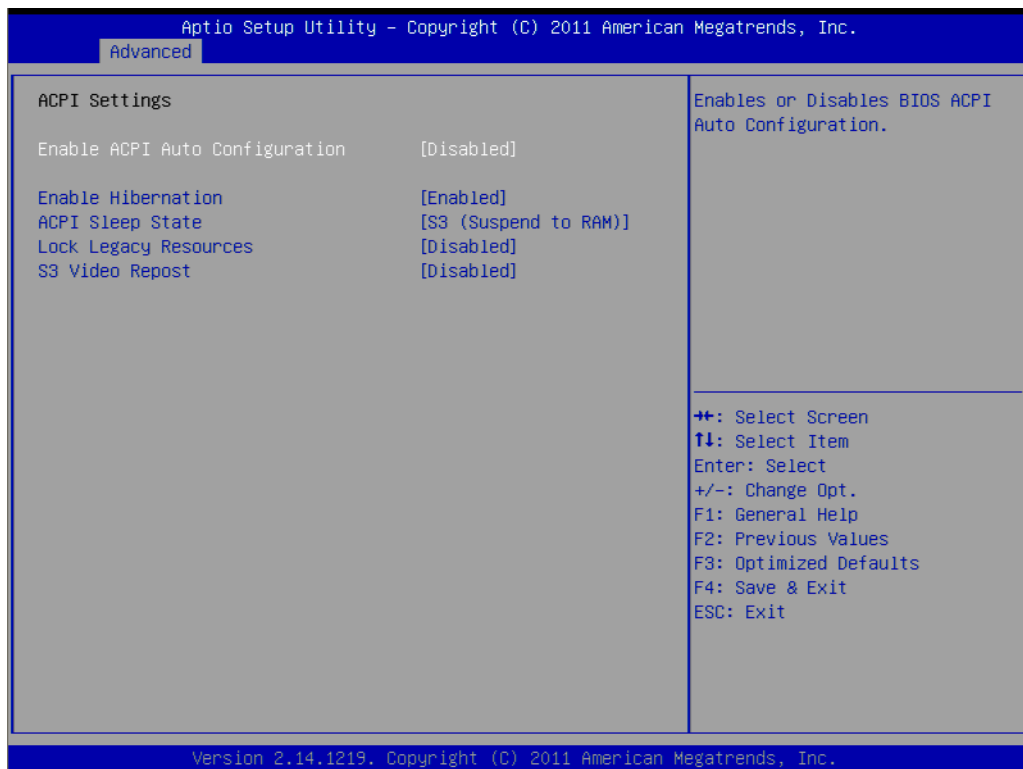

Figure 3.3 Advanced BIOS Features Setup Screen

### 3.2.2.1 ACPI Settings



**Figure 3.4 ACPI Setting**

- **Enable ACPI Auto Configuration**  
This item allows users to enable or disable BIOS ACPI auto configuration.
- **ACPI Sleep State**  
This item allows users to set the ACPI sleep state.
- **Lock Legacy Resources**  
This item allows users to lock legacy devices' resources.
- **S3 Video Repost**  
This item allows users to enable or disable VBIOS run after S3 resume.

### 3.2.2.2 CPU Configuration



**Figure 3.5 CPU Configuration Settings**

- **Hyper-Threading**  
This item allows you to enable or disable Intel® Hyper Threading technology.
- **Execute Disable Bit**  
This item allows you to enable or disable the No-Execution page protection technology.
- **Limit CPUID Maximum**  
This item allows you to limit CPUID maximum value.

### 3.2.2.3 IDE Configuration

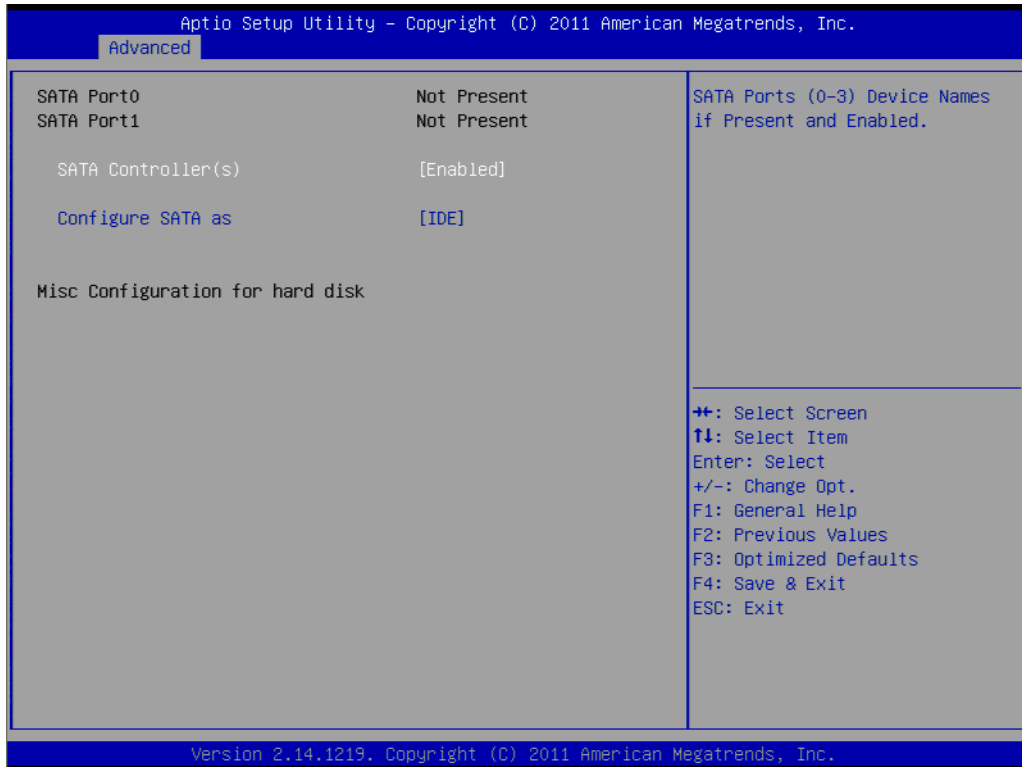
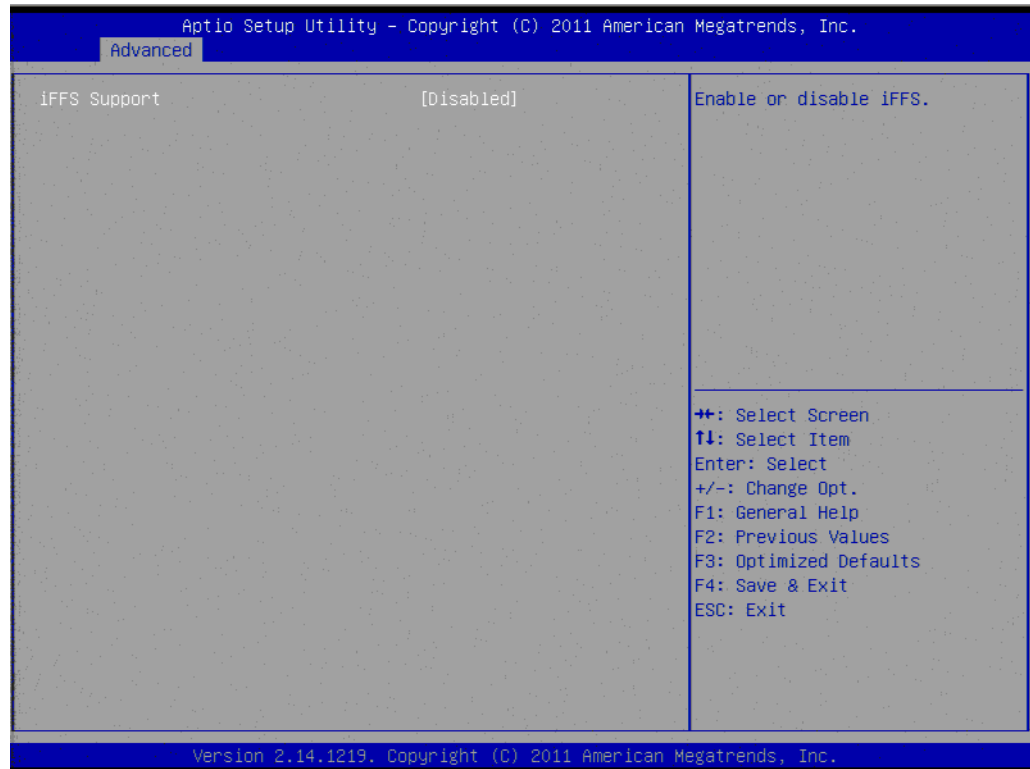

**Figure 3.6 IDE Configuration**

- **SATA Controller**

This item allows users to enable or disable the SATA controller.

### 3.2.2.4 Intel Fast Flash Standby



**Figure 3.7 Intel Fast Flash Standby**

- **IFFS Support**  
This item allows users to enable or disable IFFS support.



### 3.2.2.5 USB Configuration



**Figure 3.8 USB Configuration**

- **Legacy USB Support**  
Enable the support for legacy USB. Auto option disables legacy support if no USB devices are connected.
- **EHCI Hand-Off**  
This is a workaround for the OS without EHCI hand-off support. The EHCI ownership change should be claimed by EHCI driver.
- **USB transfer time-out**  
Set the time-out value for Control, Bulk, and Interrupt transfers.
- **Device reset time-out**  
Set USB mass storage device Start Unit command time-out value.
- **Device power-up delay**  
Set the maximum time the device will take before it properly reports itself to the Host Controller. 'Auto' uses default value: for a Root port it is 100 ms, for a Hub port the delay is taken from Hub descriptor.

### 3.2.2.6 Super IO Configuration

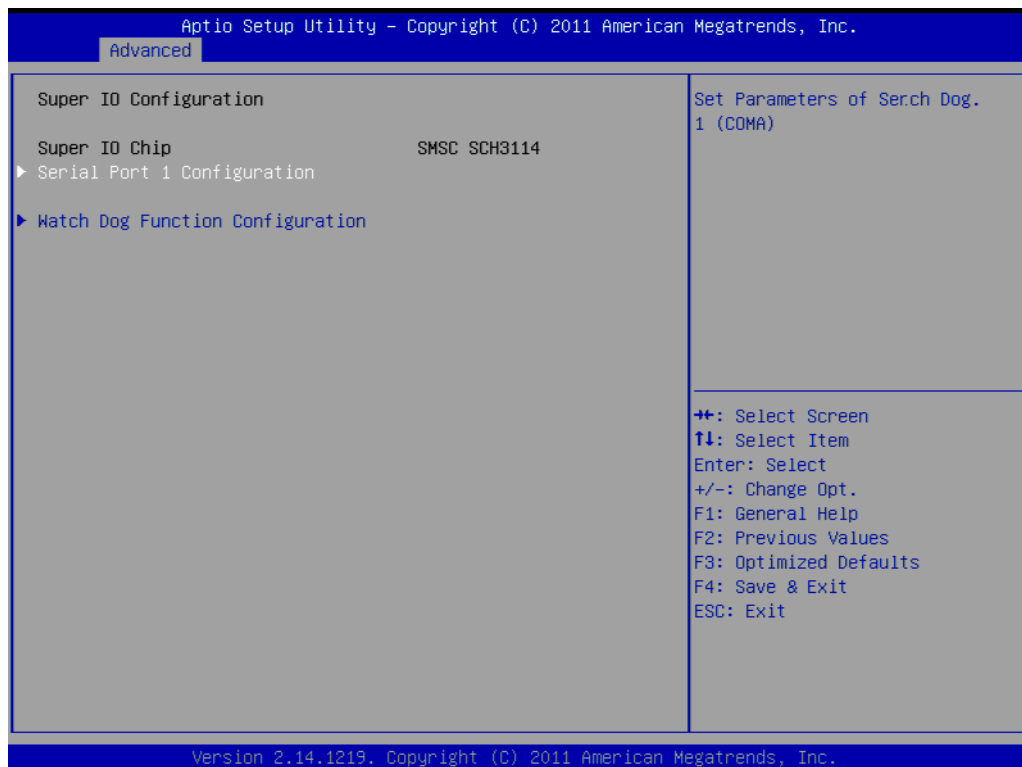
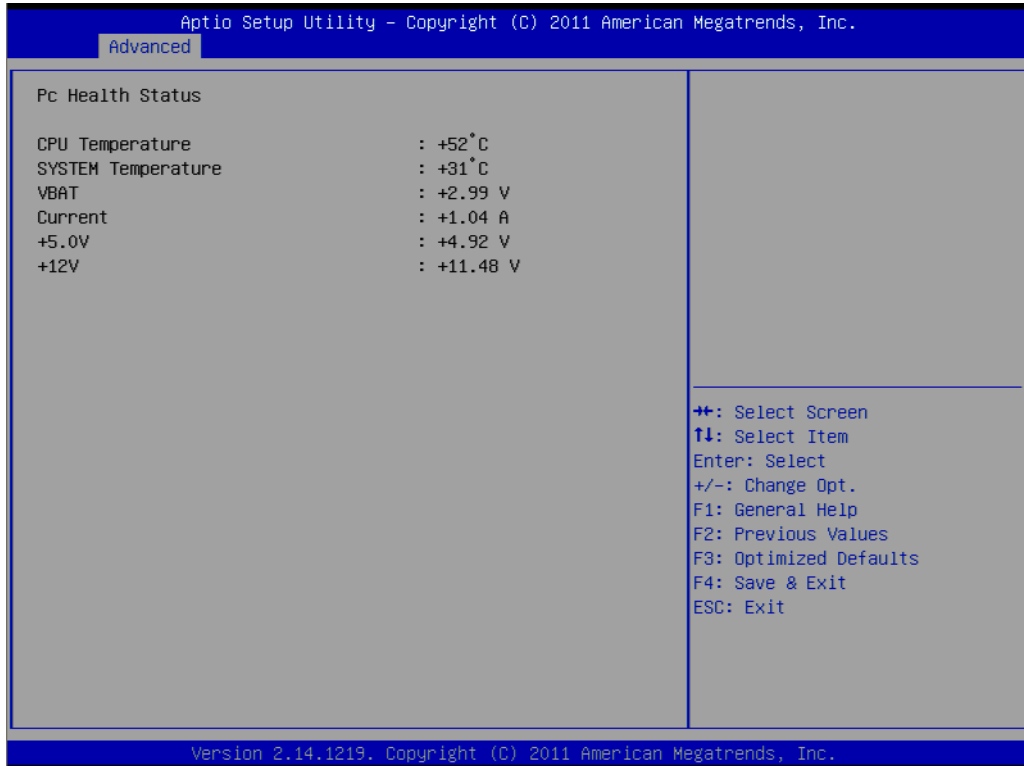

Figure 3.9 Super IO Configuration

- **Serial Port 1 configuration**  
This item allows you to select serial port1 configuration.
- **Serial Port 2 - 4 configuration (ARK-1122C only)**  
This item allows you to select serial port 2 ~ 4 configuration. Serial port3 and port4 can be set as RS-232/RS-422/RS-485. The default setting is RS-232.
- **WatchDog function**  
This item allows you to enable WatchDog function, in minutes or seconds.

### 3.2.2.7 H/W Monitor



**Figure 3.10 H/W Monitor**

- **Temperature & Voltage show**  
CPU / System Temperature / VBAT / Current / +5.0 V / +12 V

### 3.2.2.8 AOAC Configuration

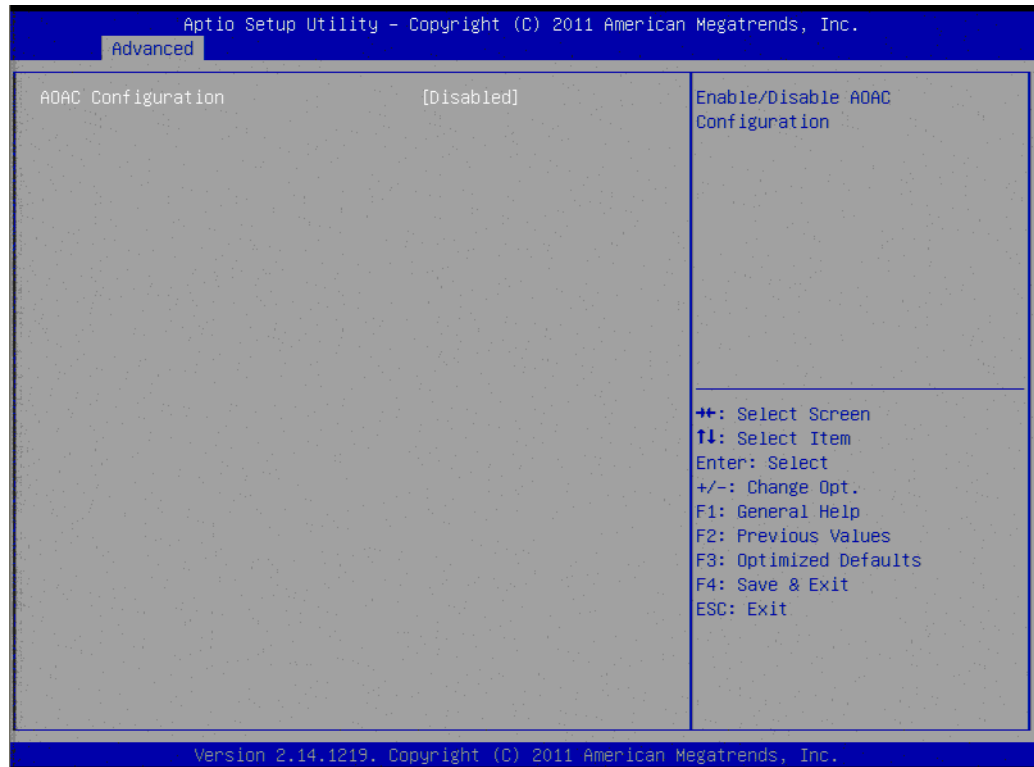

**Figure 3.11 AOAC Configuration**

- **AOAC Configuration**  
This item allows users to enable or disable AOAC Configuration.

### 3.2.2.9 PPM Configuration

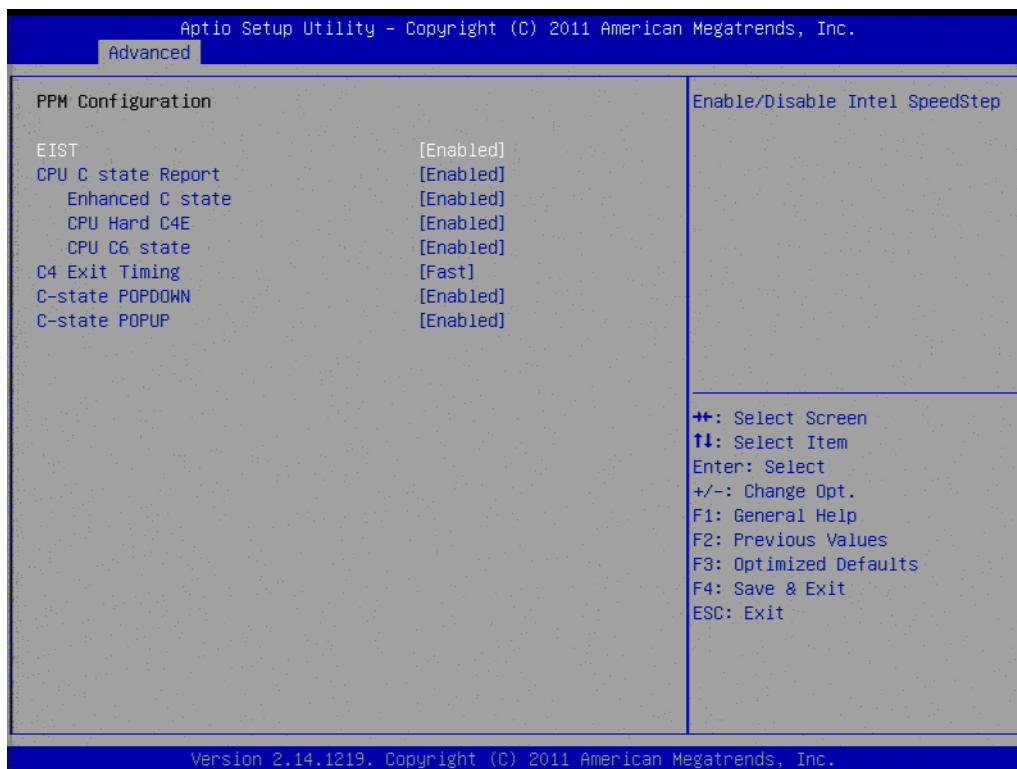

**Figure 3.12 PPM Configuration**

- **EIST**  
CPU runs at its default speed if disabled; CPU speed is controlled by the operating system if enabled.
- **CPU C State Report**  
This item allows users to enable or disable CPU C state report.
- **Enhanced C State**  
This item allows users to enable or disable enhanced C state.
- **CPU Hard C4E**  
This item allows users to enable or disable CPU hard C4E
- **CPU C6 State**  
This item allows users to enable or disable CPU C6 state.
- **C4 Exit Timing**  
This item allows users to enable or disable C4 exit timing.
- **C State POPDOWN**  
This item allows users to enable or disable C state popdown
- **C State POPUP**  
This item allows users to enable or disable C state popup.

### 3.2.3 Chipset

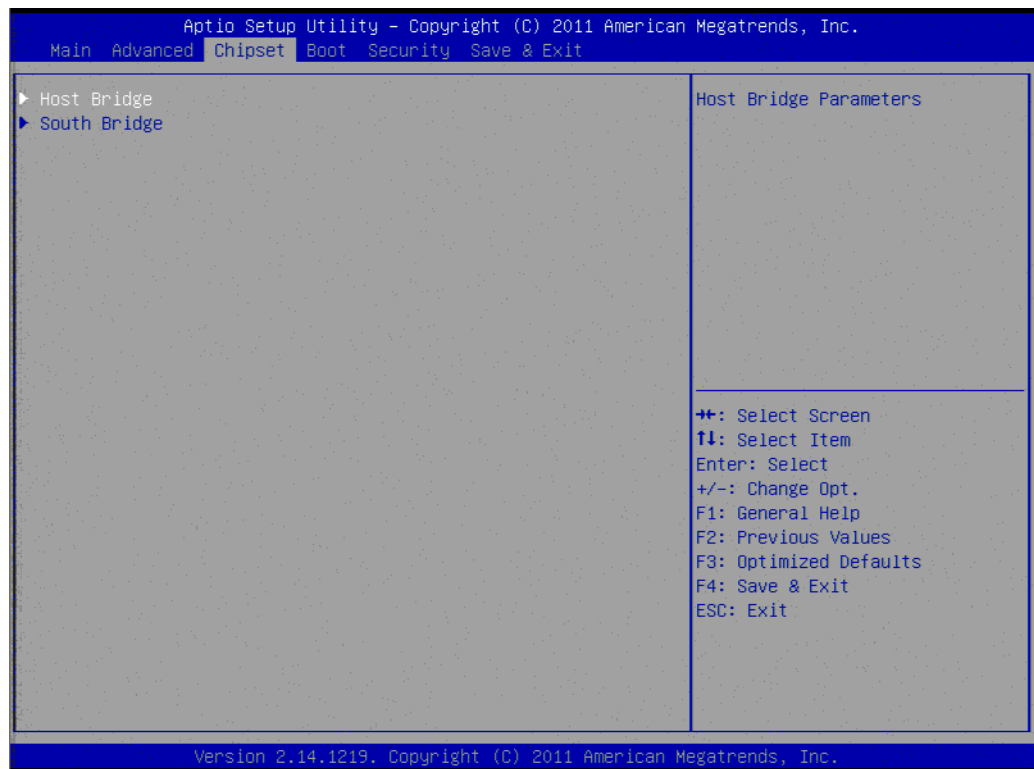

Figure 3.13 Chipset Setup

#### 3.2.3.1 Host Bridge

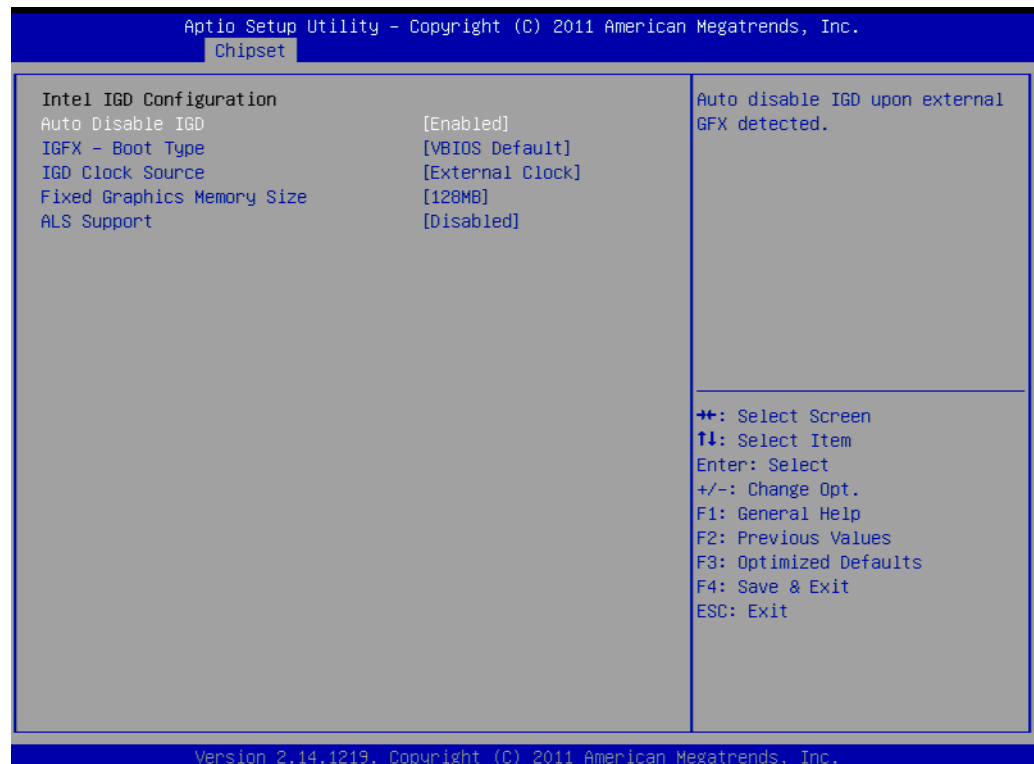
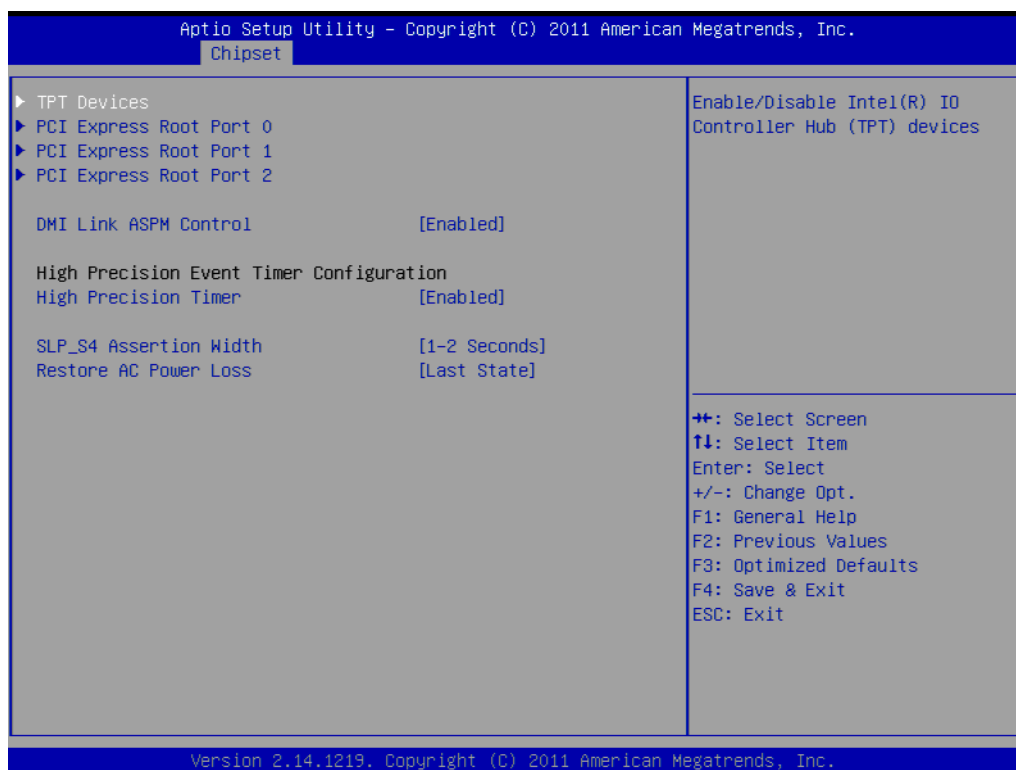

Figure 3.14 Chipset Setup

- **Auto Disable IGD**  
This item allows user to enable/disable auto disable IGD
- **IGFX - Boot Type**  
This item allows user to select IGFX boot type.
- **IGD - Clock Source**  
This item allows user to select IGD-clock source
- **ALS Support**  
This item allows user to enable/disable ALS support

### 3.2.3.2 South Bridge



**Figure 3.15 Chipset Setup**

- **DMI Link ASPM Control**  
This item allows users to enable/disable DMI link ASPM control.
- **High Precision Timer**  
This item allows users to enable/disable high precision timer.
- **SLP\_S4 Assertion Width**  
This item allows user to select the SLP\_S4 assertion width.
- **Restore AC Power Loss**  
This item allows users to select restore AC power loss.

## 3.2.4 Boot

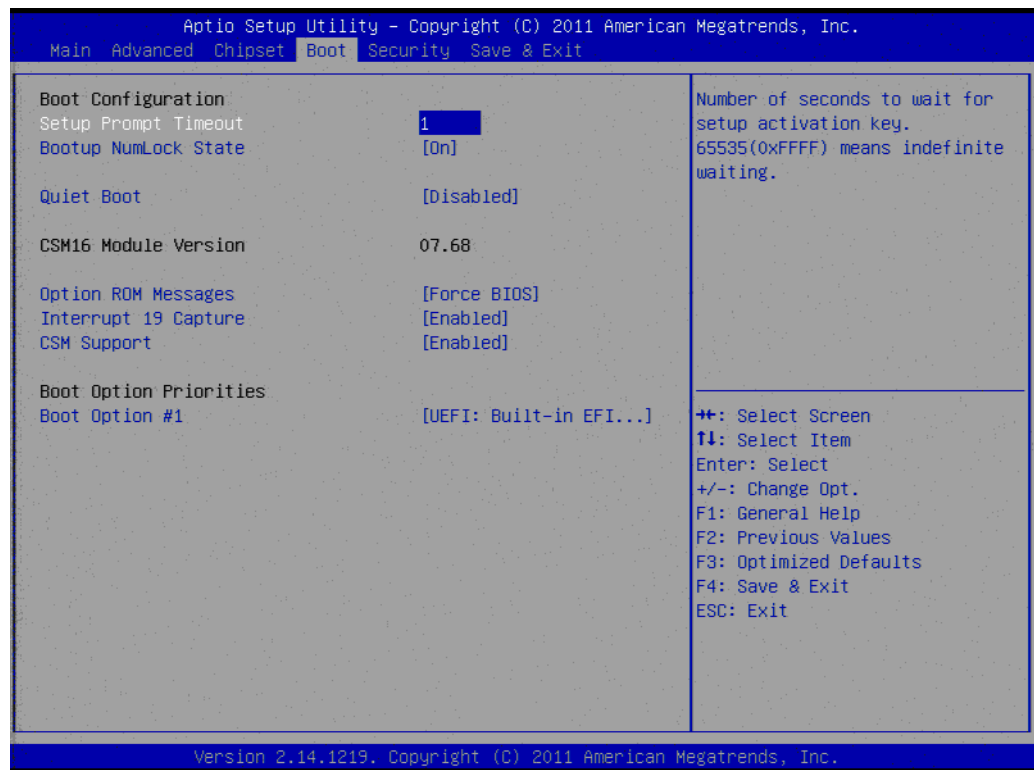
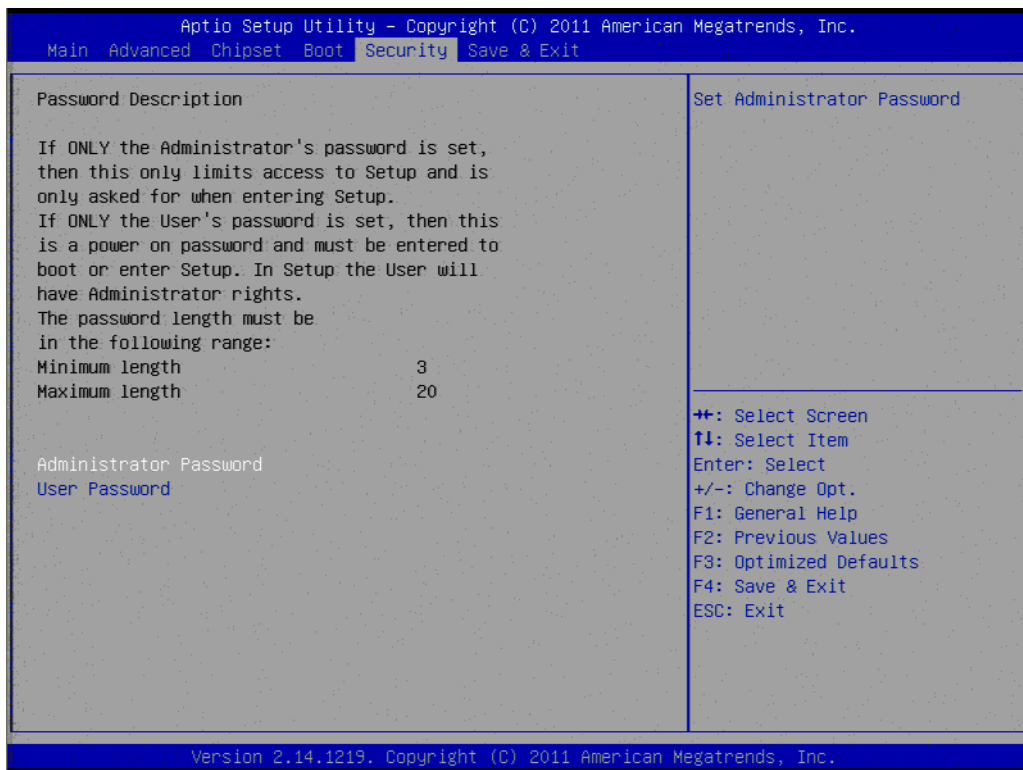

Figure 3.16 Boot Setup

- **Setup Prompt Timeout**  
This item allows users to select the number of seconds to wait for setup activation key.
- **Bootup NumLock State**  
Select the Power-on state for Numlock.
- **Quiet Boot**  
If this option is set to Disabled, the BIOS displays normal POST messages. If Enabled, an OEM Logo is shown instead of POST messages.
- **Option ROM Message**  
Set display mode for option ROM.
- **Interrupt 19 Capture**  
This item allows option ROMs to trap interrupt 19.
- **CSM Support**  
This item allows users to enable/disable CSM support.



### 3.2.5 Security Settings



**Figure 3.17 Security Setup**

Select Security Setup from the ARK-1122 Setup main BIOS setup menu. All Security Setup options, such as password protection and virus protection are described in this section. To access the sub menu for the following items, select the item and press <Enter>:

- **Administrator Password**  
This item allows user to set up password for protection.

## 3.2.6 Save & Exit

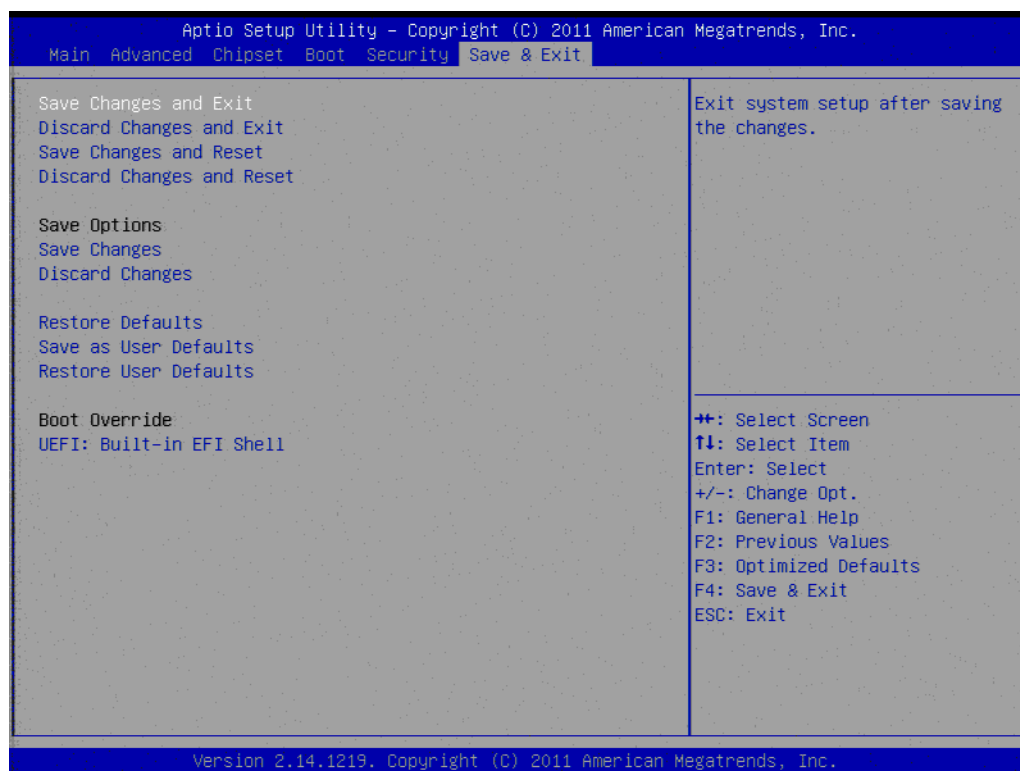

Figure 3.18 Save & Exit Setup

- **Save Changes and Exit**

When users have completed system configuration, select this option to save changes, exit BIOS setup menu and reboot the computer if necessary to take effect all system configuration parameters.
- **Discard Changes and Exit**

Select this option to quit Setup without making any permanent changes to the system configuration.
- **Save Changes and Reset**

When users have completed system configuration, select this option to save changes, exit BIOS setup menu and reboot the computer to take effect all system configuration parameters.
- **Discard Changes and Reset**

Select this option to quit Setup without making any permanent changes to the system configuration and reboot the computer.
- **Save Changes**

When users have completed system configuration, select this option to save changes without exit BIOS setup menu.
- **Discard Changes**

Select this option to discard any current changes and load previous system configuration.
- **Restore Defaults**

The ARK-1122 automatically configures all setup items to optimal settings when users select this option. Optimal Defaults are designed for maximum system performance, but may not work best for all computer applications. In particular, do not use the Optimal Defaults if the user's computer is experiencing system configuration problems.

- **Save User Defaults**

When users have completed system configuration, select this option to save changes as user defaults without exit BIOS setup menu.

- **Restore User Defaults**

The users can select this option to restore user defaults.



# Appendix **A**

WDT & GPIO Sample  
Code

## A.1 Watchdog Timer Sample Code

### Watchdog function:

```
;The SCH3114 Runtime base I/O address is A00h
;Setting WatchDog time value location at offset 66h
;If set value "0", it is mean disable WatchDog function.
Superio_GPIO_Port = A00h
mov dx,Superio_GPIO_Port + 66h
mov al,00h
out dx,al
.model small
.486p
.stack 256
.data
SCH3114_IO EQU A00h
.code
org 100h
.STARTup
;=====
;47H
;enable WDT function bit [0]=0Ch
;=====
mov dx,SCH3114_IO + 47h
mov al,0Ch
out dx,al
;=====
;65H
;bit [1:0]=Reserved
;bit [6:2]Reserve=00000
;bit [7] WDT time-out Value Units Select
;Minutes=0 (default) Seconds=1
;=====
mov dx,SCH3114_IO + 65h ;
mov al,080h
out dx,al
;=====
;66H
;WDT timer time-out value
;bit[7:0]=0~255
;=====
mov dx,SCH3114_IO + 66h
mov al,01h
out dx,al
;=====
;bit[0] status bit R/W
;WD timeout occurred =1
```

```
;WD timer counting = 0  
;=====  
mov dx,SCH3114_IO + 68h  
mov al,01h  
out dx,al  
.exit  
END
```





**ADVANTECH**

*Enabling an Intelligent Planet*

**[www.advantech.com](http://www.advantech.com)**

Please verify specifications before quoting. This guide is intended for reference purposes only.

All product specifications are subject to change without notice.

No part of this publication may be reproduced in any form or by any means, electronic, photocopying, recording or otherwise, without prior written permission of the publisher.

All brand and product names are trademarks or registered trademarks of their respective companies.

© Advantech Co., Ltd. 2014